

# User Manual

## Pocket Pro™ TDS<sub>LR</sub>, TDS<sub>HR</sub>

---

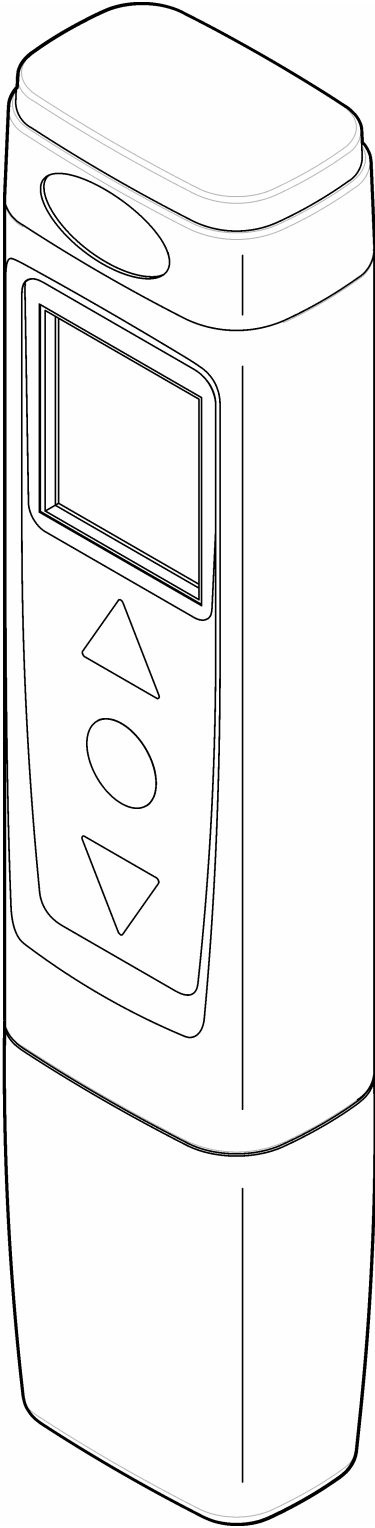

## Specifications

Specifications are subject to change without notice.

Specification	Details
Dimensions (W x D x H)	37 x 30 x 170 mm (1.45 x 1.18 x 6.69 in.)
Enclosure rating	IP67
Weight	135 g (0.297 lb) with batteries
Power requirements (internal)	AAA alkaline batteries (4x)
Battery life	450 hours
Operating temperature	0 to 50 °C (32 to 122 °F)
Storage temperature	-20 to 60 °C (-4 to 140 °F)
Operating humidity	80% (non-condensing)
Altitude	2000 m (6562 ft)
Instrument range	TDS <sub>LR</sub> : 0 to 1999 ppm; TDS <sub>HR</sub> : 0 to 10.00 ppt
Resolution	TDS <sub>LR</sub> : 1 ppm; TDS <sub>HR</sub> : 0.1 ppt
Accuracy	TDS <sub>LR</sub> : ±1% FS <sup>1</sup> ; TDS <sub>HR</sub> : ±2% FS
Calibration points	TDS <sub>LR</sub> : 2 points (auto), 1 point (custom); TDS <sub>HR</sub> : 1 point (auto and custom) <b>Note:</b> Temperature calibration is not available.
Auto-recognition calibration standards	TDS <sub>LR</sub> : 147 µS/cm and 1413 µS/cm; TDS <sub>HR</sub> : 12.88 mS/cm
Certifications	CE mark, FCC, Industry Canada, KC Mark, RCM, China RoHS
Warranty	1 year for manufacturing faults only. Damage from use is not covered.

## General information

In no event will the manufacturer be liable for damages resulting from any improper use of product or failure to comply with the instructions in the manual. The manufacturer reserves the right to make changes in this manual and the products it describes at any time, without notice or obligation. Revised editions are found on the manufacturer's website.

## Safety information

The manufacturer is not responsible for any damages due to misapplication or misuse of this product including, without limitation, direct, incidental and consequential damages, and disclaims such damages to the full extent permitted under applicable law. The user is solely responsible to identify critical application risks and install appropriate mechanisms to protect processes during a possible equipment malfunction.

Please read this entire manual before unpacking, setting up or operating this equipment. Pay attention to all danger and caution statements. Failure to do so could result in serious injury to the operator or damage to the equipment.

Make sure that the protection provided by this equipment is not impaired. Do not use or install this equipment in any manner other than that specified in this manual.

## Use of hazard information

**⚠ DANGER**

Indicates a potentially or imminently hazardous situation which, if not avoided, will result in death or serious injury.

<sup>1</sup> Based on a 2-point calibration and the TDS range of the calibration standards includes the TDS value of the water sample.

## ⚠ WARNING

Indicates a potentially or imminently hazardous situation which, if not avoided, could result in death or serious injury.

## ⚠ CAUTION



Indicates a potentially hazardous situation that may result in minor or moderate injury.

## NOTICE

Indicates a situation which, if not avoided, may cause damage to the instrument. Information that requires special emphasis.

### Precautionary labels

Read all labels and tags attached to the instrument. Personal injury or damage to the instrument could occur if not observed. A symbol on the instrument is referenced in the manual with a precautionary statement.

	This symbol, if noted on the instrument, references the instruction manual for operation and/or safety information.
	Electrical equipment marked with this symbol may not be disposed of in European domestic or public disposal systems. Return old or end-of-life equipment to the manufacturer for disposal at no charge to the user.

### Certification

#### Canadian Radio Interference-Causing Equipment Regulation, ICES-003, Class B:

Supporting test records reside with the manufacturer.

This Class B digital apparatus meets all requirements of the Canadian Interference-Causing Equipment Regulations.

Cet appareil numérique de classe B répond à toutes les exigences de la réglementation canadienne sur les équipements provoquant des interférences.

#### FCC Part 15, Class "B" Limits

Supporting test records reside with the manufacturer. The device complies with Part 15 of the FCC Rules. Operation is subject to the following conditions:

1. The equipment may not cause harmful interference.
2. The equipment must accept any interference received, including interference that may cause undesired operation.

Changes or modifications to this equipment not expressly approved by the party responsible for compliance could void the user's authority to operate the equipment. This equipment has been tested and found to comply with the limits for a Class B digital device, pursuant to Part 15 of the FCC rules. These limits are designed to provide reasonable protection against harmful interference when the equipment is operated in a commercial environment. This equipment generates, uses and can radiate radio frequency energy and, if not installed and used in accordance with the instruction manual, may cause harmful interference to radio communications. Operation of this equipment in a residential area is likely to cause harmful interference, in which case the user will be required to correct the interference at their expense. The following techniques can be used to reduce interference problems:

1. Move the equipment away from the device receiving the interference.
2. Reposition the receiving antenna for the device receiving the interference.
3. Try combinations of the above.

### Product overview

The Pocket Pro™ TDS<sub>LR</sub> tester and TDS<sub>HR</sub> tester measure the TDS of general water samples. Refer to [Figure 1](#). These tester is waterproof and floats.

**Figure 1 Product features**

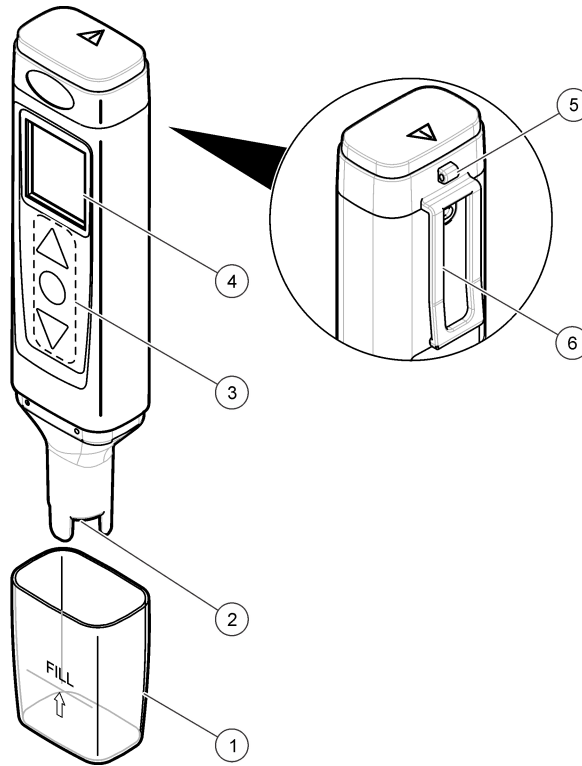

1 Sensor cap	3 Keypad	5 Lanyard attachment
2 Sensor	4 Display	6 Pocket clip

**Product components**

Make sure that all components have been received. Refer to [Figure 2](#). If any items are missing or damaged, contact the manufacturer or a sales representative immediately.

**Figure 2 Product components**

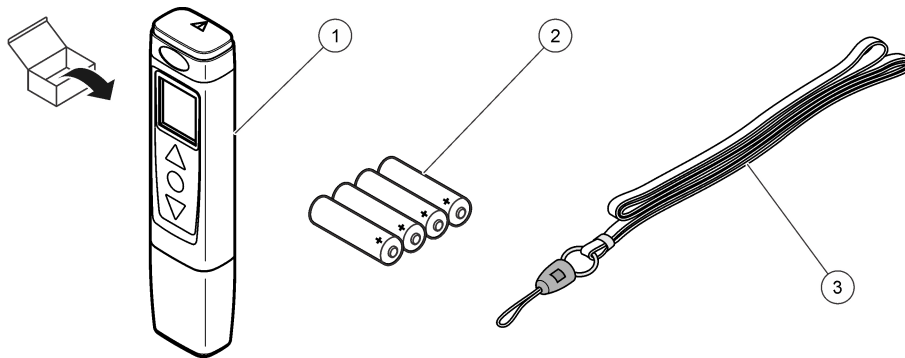

1 Pocket Pro tester	3 Lanyard
2 AAA alkaline batteries (4x)	

**Install the batteries**

<b>⚠ CAUTION</b>	
	Explosion hazard. Incorrect battery installation can cause the release of explosive gases. Be sure that the batteries are of the same approved chemical type and are inserted in the correct orientation. Do not mix new and used batteries.

## ⚠ WARNING



Fire hazard. Battery substitution is not permitted. Use only alkaline batteries.

Install the four AAA alkaline batteries in the tester. Refer to the illustrated steps in [Figure 3](#).

**Figure 3 Install the batteries**

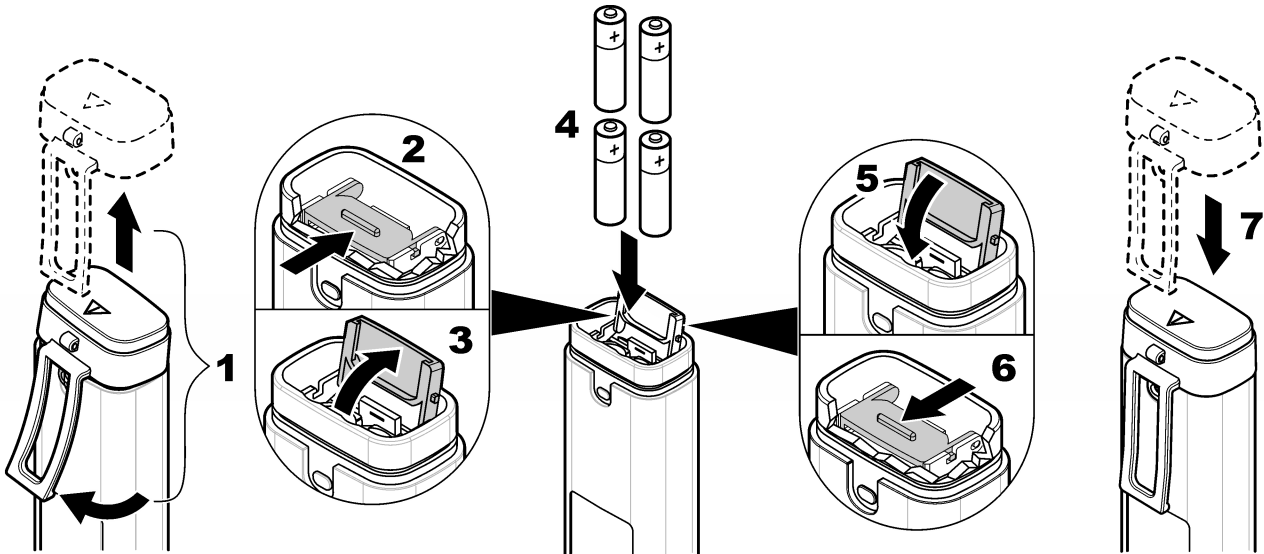

## User interface and navigation

### Display description

[Figure 4](#) shows the measurements, calibration standard information and indicator icons shown on the display. [Table 1](#) gives descriptions of the icons.



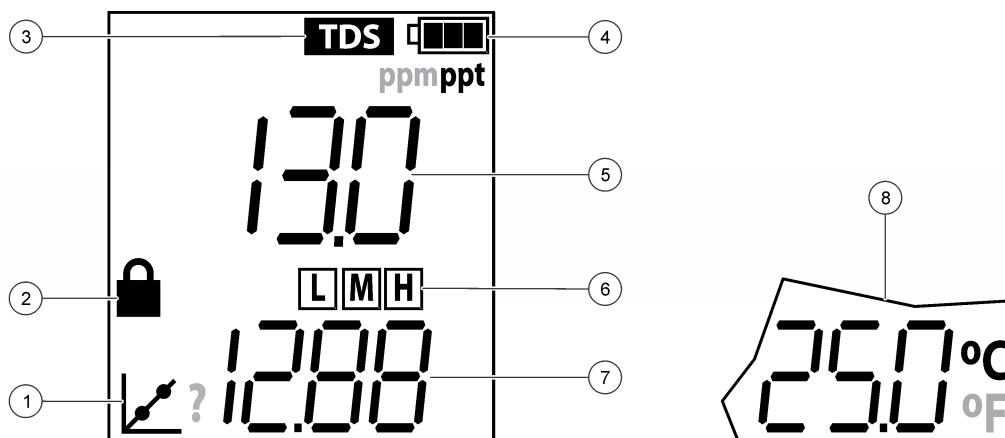

**Figure 4 Display overview**



1 Calibration icon	4 Battery icon	7 Calibration standard(s) expected <sup>2</sup>
2 Lock icon	5 Parameter value	8 Temperature
3 Parameter	6 Calibration standard(s) measured for last calibration (low, medium, high)	

<sup>2</sup> Shows during calibration

**Table 1 Display icons**

Icon	Description
	Shows the battery power level. Flashes when the battery power is less than 10%.
	Shows when the lock feature is on. When the lock feature is on, the parameter value on the display does not change. Push  to set the lock feature to on or off.
	Shows when the tester is in calibration mode or when a calibration is due. If "?" shows next to the calibration icon, the last calibration was not successful.

## Keypad description

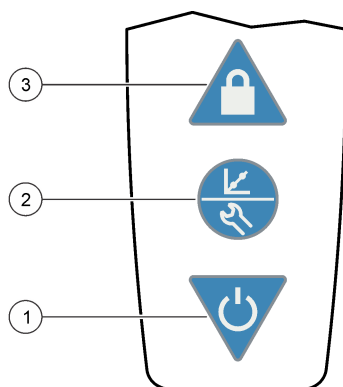

Figure 5 shows the keypad. Table 2 gives the key descriptions.

**Figure 5 Keypad overview**



1 Power key	2 Calibration/Settings key	3 Lock key
-------------	----------------------------	------------

**Table 2 Key functions**

Key	Description
	Push and hold to set the power to on or off.
	Push to start a calibration. To exit a calibration, push and hold. Push and hold until "SEt" shows on the display to go to the settings menu. To exit the settings menu, push and hold until "End" shows on the display. When in the settings menu, push to scroll through the settings. <b>Note:</b> Power cannot be set to off while in settings or calibration mode.
	Push to set the lock feature to on or off. When the lock feature is on, the lock icon shows and the parameter value on the display does not change.

## Calibration

### ⚠ CAUTION



Chemical exposure hazard. Obey laboratory safety procedures and wear all of the personal protective equipment appropriate to the chemicals that are handled. Refer to the current safety data sheets (MSDS/SDS) for safety protocols.



Calibrate the tester before initial use and when:

- Results drift
- Results are not accurate

---



## Calibrate

**Items to collect:** TDS<sub>HR</sub> tester: One auto-recognition calibration standard, TDS<sub>LR</sub> tester: One or two auto-recognition calibration standards

1. Set the power to on.
2. Remove the cap from the sensor.
3. Push  to go to calibration mode.  
The auto-recognition standard(s) the tester expects to measure shows on the bottom line.
4. Rinse the sensor and cap with deionized water and blot dry.
5. Pour the calibration standard shown into the cap to the fill line.
6. Put the sensor fully into the cap.
7. When the measurement is stable, push  to save the calibration and go to continuous measurement mode.  
The measured value will flash 3 times and then stop. Then, "END" shows on the display.
8. (Optional) For the LR tester, to measure a second calibration standard, do steps 4–7 again.
9. Rinse the sensor and cap with deionized water and blot dry.



## Measurement

**Note:** Air bubbles under the probe tip when submerged can cause slow stabilization or error in measurement. Shake the tester from side to side to remove air bubbles.



1. Set the power to on.
2. Remove the cap from the sensor.
3. If the lock icon shows on the display, push  to go to continuous measurement mode.
4. Rinse the sensor and cap with deionized water and blot dry.
5. Pour the water sample into the cap to the fill line.
6. Put the sensor fully into the cap. The measured value shows on the top line.
7. To keep the measured value on the display when the sensor is removed from the sample, push .  
**Note:** The lock icon shows on the display when the measurement is stable.
8. To measure another sample, do steps 3–7.
9. When done with measurements:
  - a. Rinse the sensor and cap with deionized water.
  - b. Put the cap on the tester.
  - c. Set the power to off.

## Advanced operation

### Configure the settings

1. Push and hold  until "SET" shows on the display.
2. Push  to scroll through the settings. The current value of the setting shows on the bottom line.

Option	Description
Unit	Select the temperature unit that shows on the display— C (Celsius) or F (Fahrenheit).
Fctr	Enter the TDS factor— 0.40 to 1.00 (default = 0.71)
AOFF	Set the auto-off feature to On (enable, default) or Off (disabled). When set to On, power is automatically set to off after 8 minutes of no activity.
rSEt	Change the settings to the factory defaults—Yes or No (default). When set to Yes, changes the settings to the factory settings and default values.

3. To change the value of the setting, push  or .
4. When done with changes, push and hold  until "End" shows to go to continuous measurement mode.

## Maintenance

### ⚠ CAUTION



Multiple hazards. Only qualified personnel must conduct the tasks described in this section of the document.

### Clean the sensor

Clean the sensor when:

- Stabilization is slow
  - Results drift or are not accurate
  - Calibration failure occurs
1. Soak the sensor in the applicable cleaning agent. Refer to [Table 3](#).
  2. Rinse or soak the sensor in deionized water for 1 minute.

**Table 3 Cleaning agents**

Contaminant	Cleaning agent	Time
Grease, oils and fats	Electrode cleaning solution	2 hours maximum
Mineral buildup	10% hydrochloric acid (HCl) solution	5 minutes maximum

### Replace the batteries

When the battery icon flashes or the tester will not come on, replace all four batteries. Refer to [Install the batteries](#) on page 4.

### Troubleshooting

Message	Possible cause	Solution
"- - - -" (top line)	The parameter value is not within the measurement range of the tester. Refer to <a href="#">Specifications</a> on page 2.	Make sure that the value of the sample is within the measurement range of the tester. Gently clean the sensor. Refer to <a href="#">Clean the sensor</a> on page 8. Calibrate as necessary.
"- - - -" (bottom line)	The temperature value is not within the operating temperature range of the tester or a temperature sensor failure occurred. Refer to <a href="#">Specifications</a> on page 2 for the operating temperature range.	Make sure that the sample temperature is within the operating temperature range of the tester. Contact technical support as necessary. <b>Note:</b> <i>The tester can still be used if a temperature sensor failure has occurred, but without automatic temperature compensation.</i>
Battery icon flashes	The batteries have less than 10% power remaining.	Replace all four batteries. Refer to <a href="#">Install the batteries</a> on page 4.

### Replacement parts and accessories

### ⚠ WARNING



Personal injury hazard. Use of non-approved parts may cause personal injury, damage to the instrument or equipment malfunction. The replacement parts in this section are approved by the manufacturer.

**Note:** *Product and Article numbers may vary for some selling regions. Contact the appropriate distributor or refer to the company website for contact information.*



**Table 4 Replacement parts**

<b>Description</b>	<b>Quantity</b>	<b>Item no.</b>
AAA alkaline batteries	4/pkg	4674300
Lanyard	1	201305
SINGLET, for LR tester, 1413 $\mu\text{S}/\text{cm}$	20/pkg	2771420
SINGLET, for HR tester, 12.88 $\text{mS}/\text{cm}$	20/pkg	2771520

**Table 5 Accessories**

<b>Description</b>	<b>Quantity</b>	<b>Item no.</b>
SINGLET, for LR tester, 147 $\mu\text{S}/\text{cm}$	20/pkg	2771320
Electrode cleaning solution	500 mL	2965249
Hydrochloric Acid (HCl)	2.5 L	13406
Hydrochloric Acid (HCl)	500 mL	13449

---

**HACH COMPANY World Headquarters**

P.O. Box 389, Loveland, CO 80539-0389 U.S.A.  
Tel. (970) 669-3050  
(800) 227-4224 (U.S.A. only)  
Fax (970) 669-2932  
orders@hach.com  
www.hach.com

**HACH LANGE GMBH**

Willstätterstraße 11  
D-40549 Düsseldorf, Germany  
Tel. +49 (0) 2 11 52 88-320  
Fax +49 (0) 2 11 52 88-210  
info-de@hach.com  
www.de.hach.com

**HACH LANGE Sàrl**

6, route de Compois  
1222 Vézenaz  
SWITZERLAND  
Tel. +41 22 594 6400  
Fax +41 22 594 6499

