



DOC022.52.93074

TitraLab® AT1000 series workstations

User Manual

12/2022, Edition 10

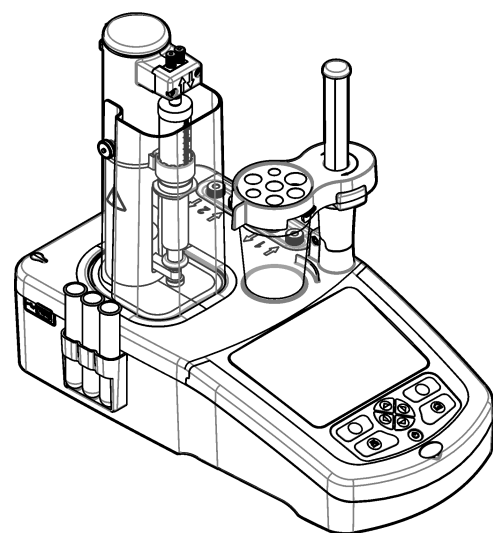

Section 1 Specifications	3
Section 2 General information	5
2.1 Safety information.....	5
2.1.1 Use of hazard information.....	5
2.1.2 Precautionary labels.....	5
2.1.3 Compliance and certification.....	6
2.1.4 Restriction of hazardous substances (RoHS).....	6
2.2 Product overview.....	7
2.3 Instrument connections.....	8
2.4 Product components.....	9
Section 3 Installation	11
3.1 Installation guidelines.....	11
3.2 Connect to AC power.....	11
3.3 Install the syringe.....	12
3.4 Install the sensor storage tubes.....	13
3.5 Install the stir bar and the beaker.....	13
3.6 Prepare the tubes.....	13
3.7 Connect the tubes.....	14
3.8 Install the sensor.....	14
3.8.1 Install the legacy adapter.....	14
3.8.1.1 Set the legacy adapter settings.....	15
3.8.2 Connect the sensor.....	15
3.9 Install the titrant and the reagent.....	16
3.10 Tidy the work area.....	18
Section 4 Install accessories	19
4.1 Install an external pump.....	19
4.2 Install an external propeller.....	21
4.3 Install a balance.....	21
4.4 Install PC software.....	22
4.5 Install the syringe verification kit.....	22
Section 5 User interface and navigation	25
5.1 Keypad.....	25
5.2 Home screen.....	25
5.3 Menu structure.....	26
Section 6 Startup	29
6.1 Configure the instrument.....	29
6.2 Install the applications.....	30
6.3 Prepare the instrument for measurement.....	30
Section 7 Standard operations	33
7.1 Calibration.....	33
7.1.1 Calibrate the sensor.....	33
7.1.2 Calibrate the titrant.....	34
7.1.3 Auto leveling calibration.....	35
7.2 Sample preparation.....	36
7.3 Get a sample measurement.....	36
7.4 Change the application settings.....	38
7.4.1 Sample name.....	38
7.5 Manage the data log.....	39
7.6 Purge.....	39

Table of Contents

Section 8 Maintenance	41
8.1 Maintenance schedule.....	41
8.2 Clean the instrument.....	41
8.3 Clean the sensor.....	41
8.4 Replace the tubes.....	42
8.5 Replace desiccant cartridge contents.....	42
8.6 Replace the syringe electro-valve block.....	42
8.7 Maintenance menu.....	42
8.7.1 Syringe activation.....	43
8.7.2 Pump activation.....	43
8.7.3 Syringe management.....	43
8.7.4 Syringe verification.....	43
8.7.5 Pump cassette replacement.....	44
8.7.6 Other maintenance options.....	45
8.8 Storage and transportation.....	46
8.8.1 Prepare the instrument for storage.....	46
8.8.2 Prepare the instrument for short-term storage.....	47
8.8.3 Prepare the instrument for shipment.....	47
Section 9 Troubleshooting	49
Section 10 Replacement parts and accessories	57
Appendix A Change application parameters	63
Appendix B Frequently asked questions	73
Section 13 Configure the instrument	75

Section 1 Specifications

Specifications are subject to change without notice.

Specification	Details
Dimensions (W x D x H)	22 x 40 x 36 cm (8.7 x 15.7 x 14.2 in.)
Weight	4 kg (8.8 lb)
Power requirements	Instrument: Input 24 VDC, 2.5 A External power supply: Input 100–240 VAC, 50–60 Hz, 1.5 A, Class I; output 24 VDC, 2.5 A 60 VA
Main supply voltage fluctuation	±10% of nominal voltage
Altitude	2,000 m (6,562 ft) maximum
Operating temperature	15 to 35 °C (59 to 95 °F)
Relative humidity	20 to 80%, non-condensing
Storage temperature	–5 to 40 °C (23 to 104 °F)
Overvoltage category	II
Pollution degree	2
Protection class	II
Environmental conditions	Indoor use
Certifications	Safety: IEC/EN 61010-1, UL/CSA C22.2 61010-1 EMC: IEC/EN 61326-1
EMC requirements	This product is intended to be used in a domestic or basic electromagnetic environment.
Warranty	1 year (EU: 2 years)

Section 2 General information

In no event will the manufacturer be liable for damages resulting from any improper use of product or failure to comply with the instructions in the manual. The manufacturer reserves the right to make changes in this manual and the products it describes at any time, without notice or obligation. Revised editions are found on the manufacturer's website.

2.1 Safety information

The manufacturer is not responsible for any damages due to misapplication or misuse of this product including, without limitation, direct, incidental and consequential damages, and disclaims such damages to the full extent permitted under applicable law. The user is solely responsible to identify critical application risks and install appropriate mechanisms to protect processes during a possible equipment malfunction.

Please read this entire manual before unpacking, setting up or operating this equipment. Pay attention to all danger and caution statements. Failure to do so could result in serious injury to the operator or damage to the equipment.



Make sure that the protection provided by this equipment is not impaired. Do not use or install this equipment in any manner other than that specified in this manual.

2.1.1 Use of hazard information



⚠ DANGER
Indicates a potentially or imminently hazardous situation which, if not avoided, will result in death or serious injury.
⚠ WARNING
Indicates a potentially or imminently hazardous situation which, if not avoided, could result in death or serious injury.
⚠ CAUTION
Indicates a potentially hazardous situation that may result in minor or moderate injury.
NOTICE
Indicates a situation which, if not avoided, may cause damage to the instrument. Information that requires special emphasis.

2.1.2 Precautionary labels

Read all labels and tags attached to the instrument. Personal injury or damage to the instrument could occur if not observed. A symbol on the instrument is referenced in the manual with a precautionary statement.

	This symbol, if noted on the instrument, references the instruction manual for operation and/or safety information.
	This symbol indicates that a risk of electrical shock and/or electrocution exists.

General information

	This symbol indicates the presence of devices sensitive to Electro-static Discharge (ESD) and indicates that care must be taken to prevent damage with the equipment.
	Electrical equipment marked with this symbol may not be disposed of in European domestic or public disposal systems. Return old or end-of-life equipment to the manufacturer for disposal at no charge to the user.

2.1.3 Compliance and certification

⚠ CAUTION

This equipment is not intended for use in residential environments and may not provide adequate protection to radio reception in such environments.

Canadian Radio Interference-Causing Equipment Regulation, ICES-003, Class A:

Supporting test records reside with the manufacturer.

This Class A digital apparatus meets all requirements of the Canadian Interference-Causing Equipment Regulations.

Cet appareil numérique de classe A répond à toutes les exigences de la réglementation canadienne sur les équipements provoquant des interférences.

FCC Part 15, Class "A" Limits

Supporting test records reside with the manufacturer. The device complies with Part 15 of the FCC Rules. Operation is subject to the following conditions:

1. The equipment may not cause harmful interference.
2. The equipment must accept any interference received, including interference that may cause undesired operation.

Changes or modifications to this equipment not expressly approved by the party responsible for compliance could void the user's authority to operate the equipment. This equipment has been tested and found to comply with the limits for a Class A digital device, pursuant to Part 15 of the FCC rules. These limits are designed to provide reasonable protection against harmful interference when the equipment is operated in a commercial environment. This equipment generates, uses and can radiate radio frequency energy and, if not installed and used in accordance with the instruction manual, may cause harmful interference to radio communications. Operation of this equipment in a residential area is likely to cause harmful interference, in which case the user will be required to correct the interference at their expense. The following techniques can be used to reduce interference problems:

1. Disconnect the equipment from its power source to verify that it is or is not the source of the interference.
2. If the equipment is connected to the same outlet as the device experiencing interference, connect the equipment to a different outlet.
3. Move the equipment away from the device receiving the interference.
4. Reposition the receiving antenna for the device receiving the interference.
5. Try combinations of the above.

2.1.4 Restriction of hazardous substances (RoHS)

Dieses Informationsblatt enthält Angaben, die ausschließlich für den Export dieses Gerätes in die Volksrepublik China erforderlich sind.

This document contains information which is only required for the export of this instrument into the People's Republic of China.

本手册包含的必要信息只适用于出口到中华人民共和国的仪器。

Type: AT1xxx

Name: TitraLab AT1000

Table 1 有毒有害物质或元素 (Hazardous Substance)

部件名称 (Parts)	铅 (Pb)	汞 (Hg)	镉 (Cd)	六价铬 (Cr6+)	多溴联苯 (PBB)	多溴二苯醚 (PBDE)
电阻 (Resistor)	X	○	○	○	○	○
二极管 (Diode)	X	○	○	○	○	○

O:	表示该部件中有毒有害物质在所有均质材料中的含量均为 SJ/T11363-2006 标准规定的限量要求以下 Indicates that the concentration of the hazardous substance in all homogeneous materials in the parts is below the relevant threshold of the SJ/T11363-2006 standard.
X:	表示该部件中有毒有害物质至少在某一均质材料中的含量超出 SJ/T11363-2006 标准规定的限量要求 Indicates that the concentration of the hazardous substance of at least one of all homogeneous materials in the parts is above the threshold of the SJ/T11363-2006 standard.
<p>对销售之日的所售产品, 本表显示, 朗讯供应链的电子产品信息产品可能包含这些物质。注意: 在所售产品中可能会也可能不会含有所有所列的部件</p> <p>This table shows where these substances may be found in the supply chain of "Company" electronic information products, as of the date of sale of the enclosed product. Note that some of the component types listed above may or may not be a part of the enclosed product.</p>	

	<p>除非另外特别的标注, 此标志为针对所涉及产品的环保使用期标志。某些可更换的零部件会有一个不同的环保使用期(例如, 电池单元模块) 贴在其产品上。此环保使用期限只适用于产品的手册中所规定的条件下工作。</p> <p>The Environmentally Friendly Use Period (EFUP) for all enclosed products and their parts are per the symbol shown here, unless otherwise marked. Certain field-replaceable parts have a different EFUP (for example, battery modules) and so are marked to reflect such. The Environmentally Friendly Use Period is valid only when the product is operated under the conditions defined in the product manual.</p>
---	---

2.2 Product overview

The instrument operates with digital and analog sensors to do potentiometric (AT1000 series) and volumetric (KF1000 series) titration. Measurement applications are installed on the instrument to automate the measurement process. Instructions show on the display when user intervention is required.

General information

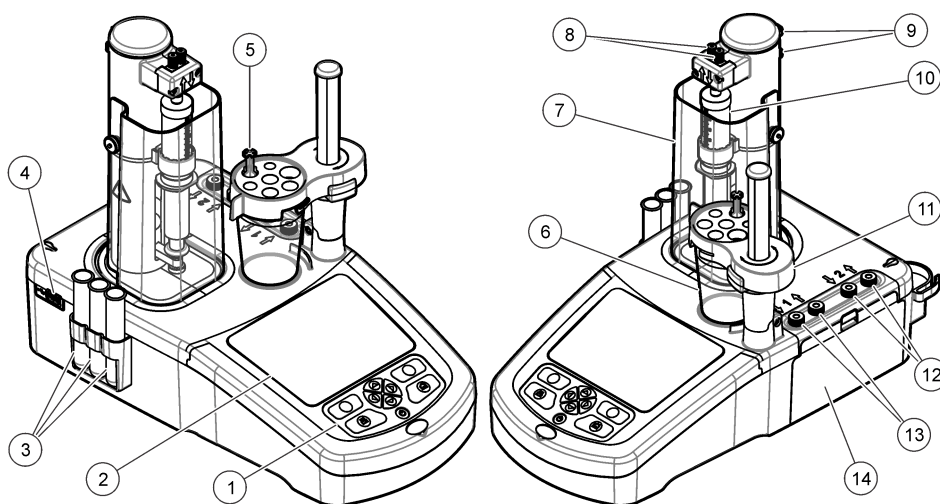

1 Keypad	6 Beaker	11 Sensor holder
2 Display	7 Syringe protection cover	12 Pump 2 input/output
3 Sensor storage tubes	8 Syringe input/output	13 Pump 1 input/output
4 USB port ¹	9 Tube clips	14 Pump access cover
5 Tube holder	10 Syringe	

Note: Depending on the model, there will be 1 or 2 syringes and syringe input/output ports, and 0, 1 or 2 pumps. Refer to [Table 2](#).

Table 2 Instrument configurations

Model	Syringes	Pumps
AT1102	1	0
AT1112	1	1
AT1122	1	2
AT1222	2	2

2.3 Instrument connections

⚠ DANGER	
	<p>Electrical shock hazard. Externally connected equipment must comply with an applicable country safety standard (e.g., IEC 60950-1 or IEC 62368-1 for IT equipment) and the circuit intended to be connected to the equipment shall not exceed the SELV (safety extra low voltage) safe level.</p>

¹ A second USB port is found on the rear of the instrument, but the instrument recognizes only one USB storage device connection at a time.

Use the USB port on the side of the instrument for the USB applications key supplied with the instrument. Use the USB port on the rear of the instrument to connect to a printer, mouse, keyboard or a USB hub.

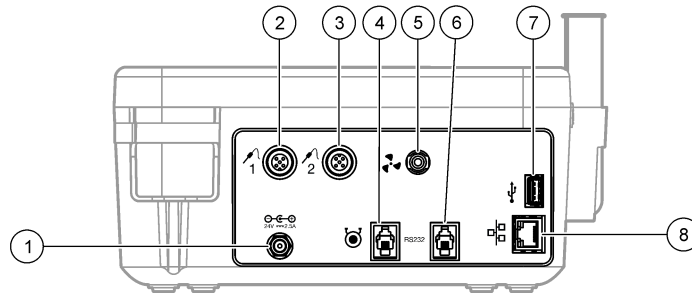

1 24 V external power supply port	4 External pump port	7 USB port
2 Sensor 1 port	5 External propeller port	8 Ethernet port
3 Sensor 2 port	6 Serial port	

2.4 Product components

Make sure that all components have been received. Refer to the packing list in the box. If any items are missing or damaged, contact the manufacturer or a sales representative immediately.

Figure 1 Contents of the instrument box

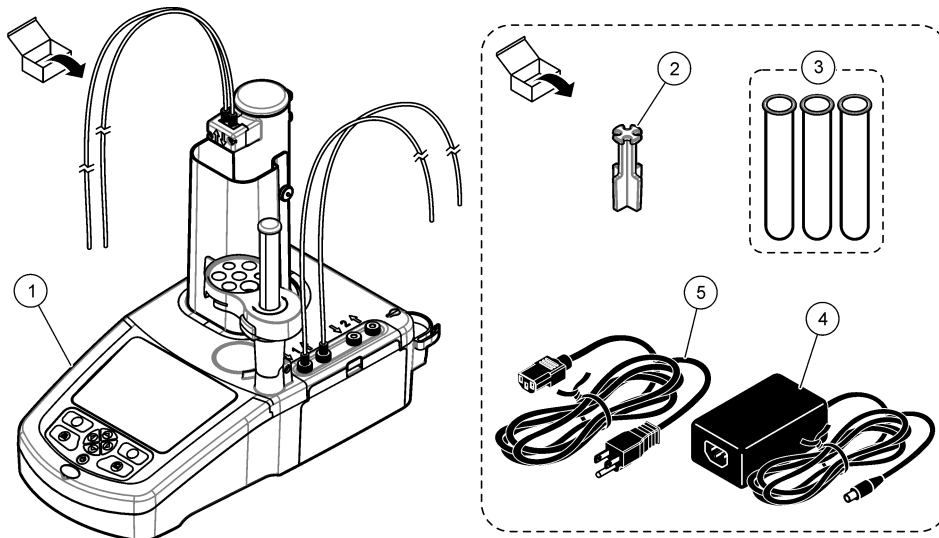

Note: For identification, the outlet tube from the syringe is fitted with a blue marker.

1 Instrument	3 Sensor storage tubes (3x)	5 Power cord
2 Tube holder (1 for each syringe position on the instrument)	4 Power supply	

General information

Figure 2 Contents of the application box

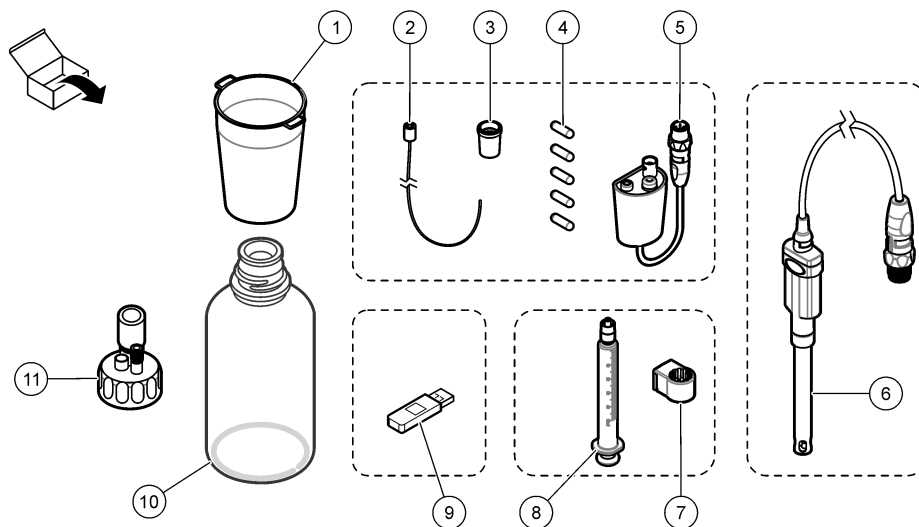

1 Beakers (5 x 50 mL and 5 x 150 mL)	7 Syringe holding ring (1 for each syringe)
2 Tube with anti-diffusion tip (if necessary for the application)	8 Syringe (refer to Table 2 on page 8 for quantity)
3 Conical adapters (quantity depends on application)	9 USB applications key
4 Magnetic stir bars	10 Glass bottles (not in all application kits)
5 Legacy sensor adapter (not in all application kits)	11 Bottle caps (type and quantity depends on application)
6 Sensor (type and quantity depends on application)	

Section 3 Installation

⚠ CAUTION	
	Multiple hazards. Only qualified personnel must conduct the tasks described in this section of the document.

NOTICE	
This is a class A product. There may be potential difficulties in ensuring electromagnetic compatibility in other environments, due to conducted as well as radiated disturbances. In a domestic environment this product may cause radio interference in which case the user may be required to take adequate measures.	

NOTICE	
Network and access point security is the responsibility of the customer that uses the wireless instrument. The manufacturer will not be liable for any damages, inclusive however not limited to indirect, special, consequential or incidental damages, that have been caused by a gap in, or breach of network security.	

The instrument is available in different configurations (refer to [Table 2](#) on page 8). This manual supplies instructions for the installation of an instrument with one syringe and one pump. Adjust the installation procedure as applicable to accommodate the number of syringes and pumps in the instrument.

3.1 Installation guidelines

- This instrument is for indoor use only.
- The mains plug must be easily accessible so the power can be disconnected quickly in case of emergency.
- Protective earth ground (PE) connection is required.
- Keep the instrument away from temperature extremes, including heaters, direct sunlight and other heat sources.
- Put the instrument on a stable and level surface in a well ventilated place.
- Make sure that there is at least 15 cm (6 in.) of space on all sides of the instrument to prevent electrical parts from overheating.
- Do not operate or keep the instrument in dusty, damp or wet locations.
- Always keep the surface of the instrument and all accessories dry and clean.

3.2 Connect to AC power

⚠ CAUTION	
	Electrical shock and fire hazards. Make sure that the supplied cord and non-locking plug meet the applicable country code requirements.

⚠ WARNING	
	Fire hazard. Use only the external power supply that is specified for this instrument.

⚠ WARNING	
	Electrocution hazard. Protective Earth Ground (PE) connection is required.

1. Connect the power cord to the power supply.
2. Connect the power supply to the instrument (refer to [Instrument connections](#) on page 8).
3. Connect the power cord to an electrical outlet.

3.3 Install the syringe

Before syringe installation, set the instrument power to on. Push the power button on the front of the instrument. Make sure that the startup sequence shows on the display. The syringe holder lowers to its operating position.

Note: Ignore any warning messages related to missing applications that show on the display.

The sensor holder has two positions: one over the magnetic stirrer and the second at 180° to the right. Move the sensor holder away from the instrument to the second position.

Refer to the illustrated steps that follow.

⚠ CAUTION

In step 6, tighten the syringe using the metallic part at the top. Do not hold the glass section of the syringe. Do not tighten too much.

To install a second syringe, do steps 5 through 7 again.

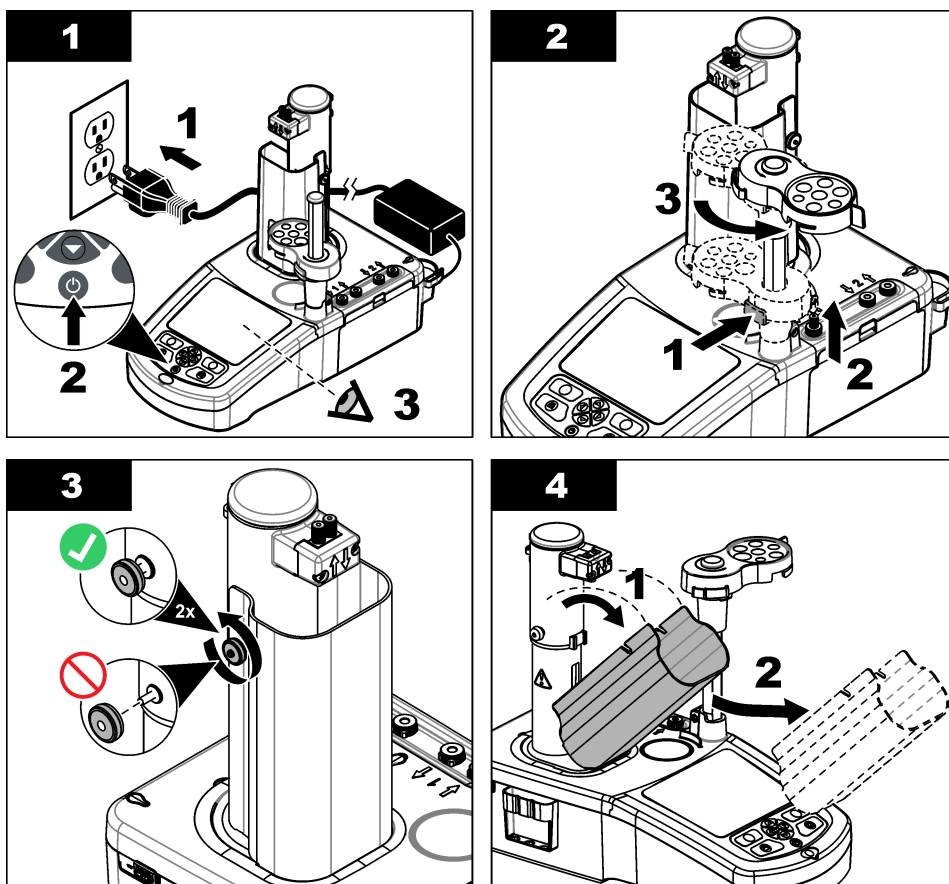

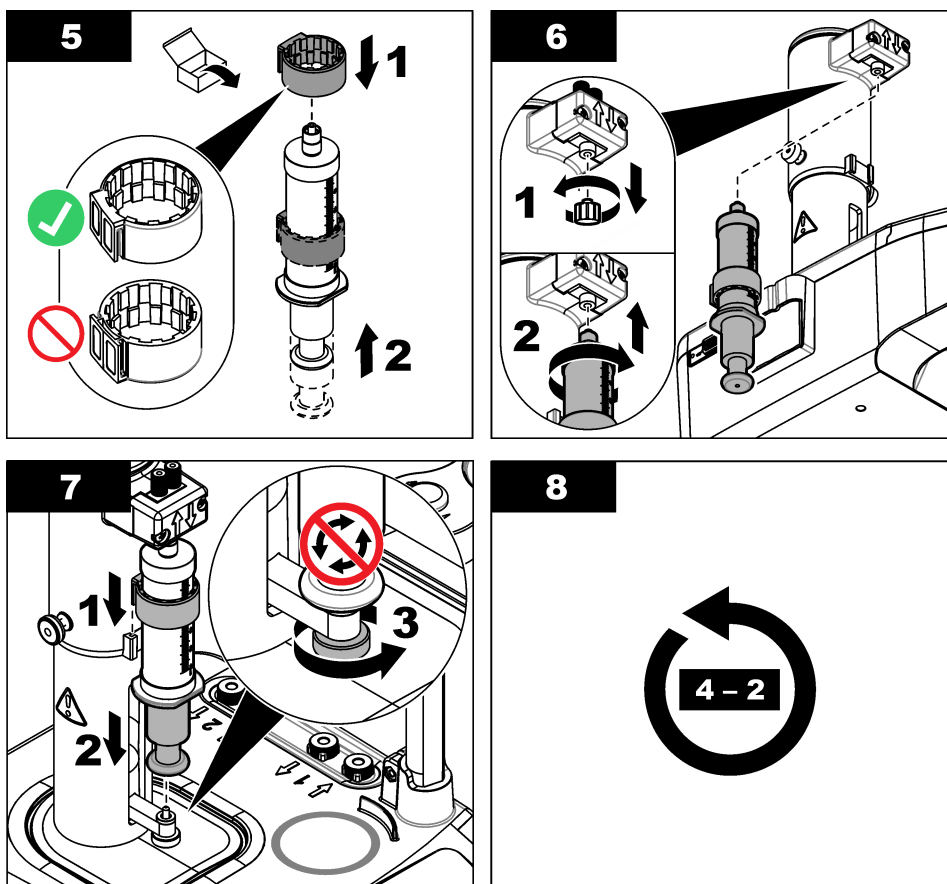

3.4 Install the sensor storage tubes

Put the three sensor storage tubes into the holder that is on the side of the instrument (refer to [Product overview](#) on page 7). Keep the sensor in a storage tube when not in use.

3.5 Install the stir bar and the beaker

Add the stir bar to the beaker, and then attach the beaker to the sensor holder.

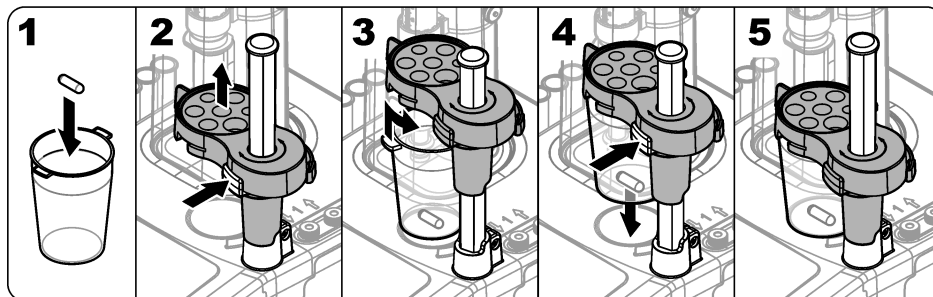

3.6 Prepare the tubes

Remove any bends in the end of the tubes.

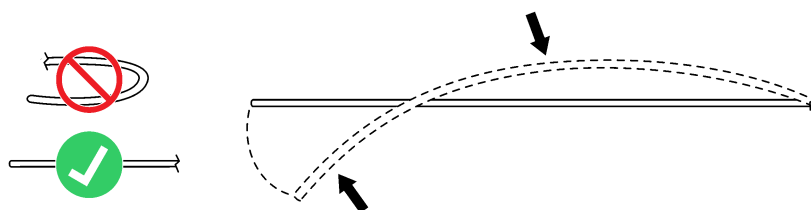

3.7 Connect the tubes

Arrow symbols identify the inlet and outlet ports for the syringe and the pump connections. The “up” arrow is the outlet port. The “down” arrow is the inlet port. Turn the tube connectors on the inlet and outlet ports of the syringe and pump until they click.

The syringe outlet tube has a blue ring on it. If anti-diffusion tips are necessary, remove the pre-installed outlet tube from the syringe and install the tube from the application kit with the pre-installed anti-diffusion tip.

Push the outlet tubes into the tube holder slots so that they are correctly attached.

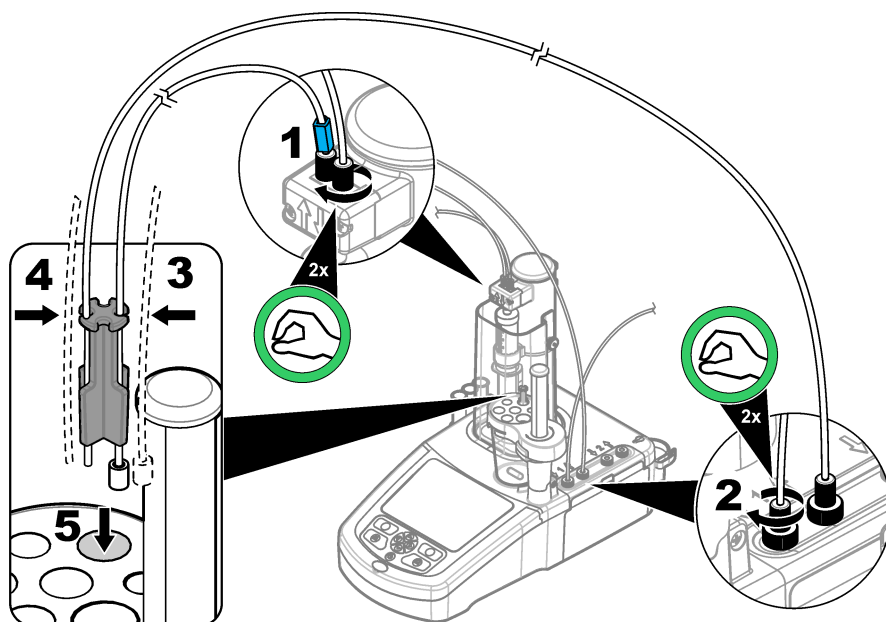

3.8 Install the sensor

3.8.1 Install the legacy adapter

Go to [Connect the sensor](#) on page 15 if no legacy adapter is included in the application kit.

1. Connect the measuring, reference and temperature sensors to the legacy adapter.
2. Make sure that the instrument display shows the Home screen. Connect the legacy adapter cable to a sensor socket on the rear panel of the instrument.

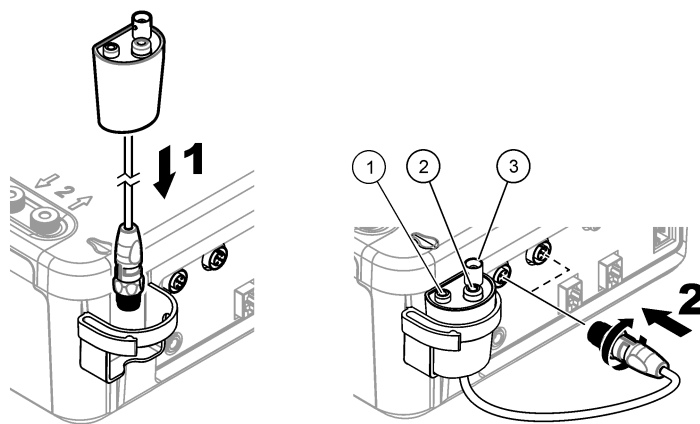

1 Temperature sensor	2 Reference sensor	3 Measuring sensor
-----------------------------	---------------------------	---------------------------

- The legacy adapter commissioning wizard automatically starts. Follow the instructions that show on the display. Select the parameter based on the connected sensor.

Option	Description
pH	Select this parameter if the connected sensor is a pH analogic sensor.
Metal/RedOX/Color	Select this parameter if the connected sensor is a Pt-Pt (metallic) analogic sensor or PTM450/OPT300 sensor.
ISE	Select this parameter if the connected sensor is an ion selective sensor.

Refer to the application documentation to enter the related information for the selected parameter.

3.8.1.1 Set the legacy adapter settings

Do the steps that follow to set a sensor name in the legacy adapter settings or set the legacy adapter settings.

- Make sure that the legacy adapter is connected to the instrument.
- From the home screen, select Settings>Legacy settings and then push Select.
- If more than one legacy adapter is connected, select the legacy adapter to change the settings.
- Select an option². Refer to the application notes for additional information.

Option	Description
Input sensor name	Enters the name of the sensor used. If specified, follow the recommendations on the application notes for the sensor name.
Input manual temperature	Sets the temperature used in the titration if no temperature sensor is connected.
Input pHIso	(pH parameter only) Sets the pH ISO value (default=7).
Reset settings	Sets the legacy adapter settings to the default configuration. Starts the legacy adapter commissioning wizard.

3.8.2 Connect the sensor

Use a conical adapter to hold the sensor tightly in the sensor holder.

² The options shown are based on the parameter selected on the legacy adapter commissioning wizard.

Connect the sensor to an available sensor port on the rear of the instrument. After the sensor is connected, make sure that the sensor icon shows in the banner at the top of the display.

NOTICE

Make sure that the sensor tip is 5 to 10 mm above the top of the magnetic stir bar to prevent any contact with the bar during operation.

Refer to the illustrated steps that follow.

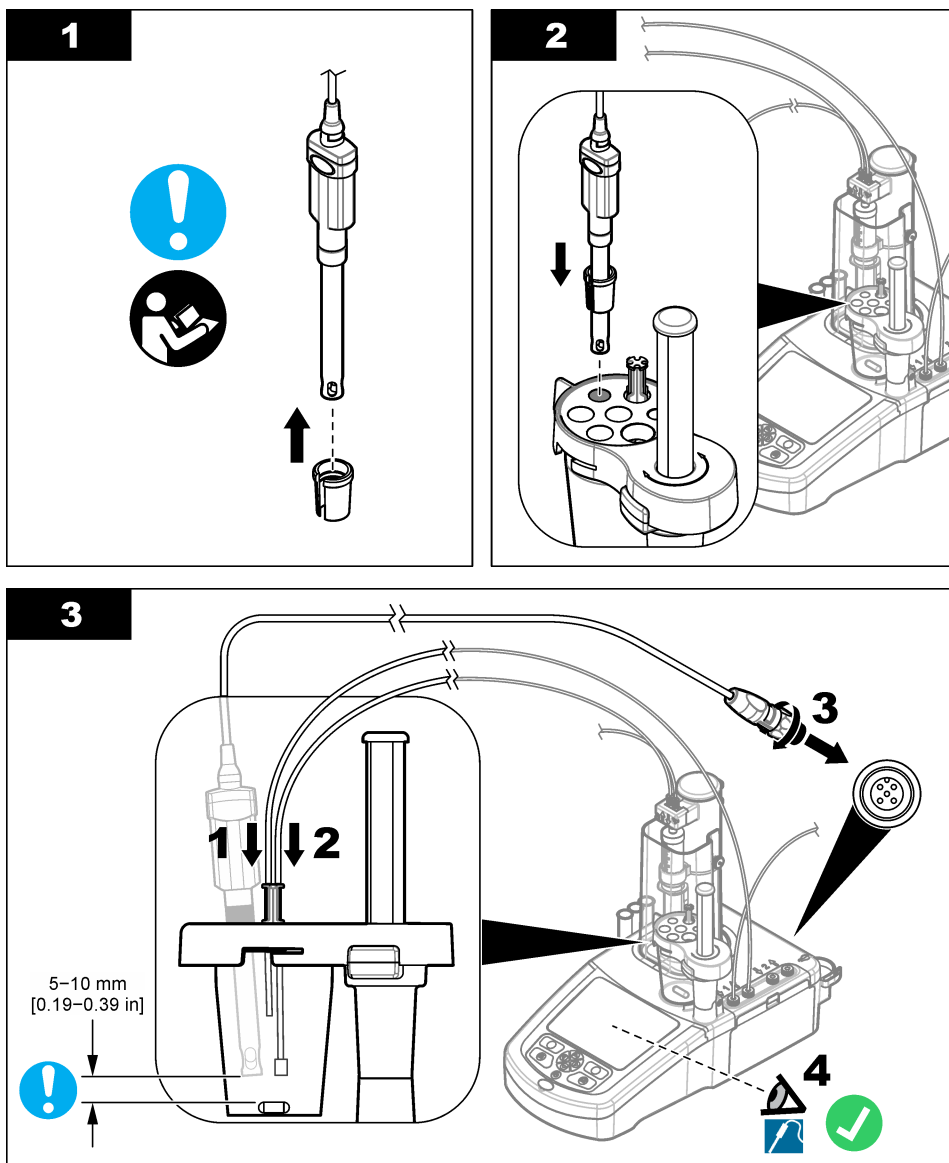

3.9 Install the titrant and the reagent

CAUTION



Chemical exposure hazard. Obey laboratory safety procedures and wear all of the personal protective equipment appropriate to the chemicals that are handled. Refer to the current safety data sheets (MSDS/SDS) for safety protocols.

⚠ CAUTION

Chemical exposure hazard. Dispose of chemicals and wastes in accordance with local, regional and national regulations.

NOTICE

This is only applicable to instruments with two syringes installed.

It is recommended to install the applications (refer to [Install the applications](#) on page 30) before installing the titrant. Applications using titrant from syringe 1 are loaded on line 1 of the home screen (refer to [Home screen](#) on page 25) and applications using titrant from syringe 2 are loaded on line 2. After the applications are installed, the correct titrant can be connected to the applicable syringe.

Optional: Fill a desiccant cartridge with an applicable desiccant. Put the desiccant cartridge into the adapter on the titrant bottle cap. Refer to the illustrated steps that follow, step 1.

Loosen the tube connector on the bottle cap. Push the inlet tube through the connector. Make sure that the end of the tube is at the bottom of the bottle. Tighten the connector on the bottle cap.

Use the same procedure to connect the second titrant bottle if a second syringe is installed on the instrument.

Refer to the "Application Note" on the USB applications key to identify the correct pump to connect to the reagent bottle. Refer to the illustrated steps that follow.

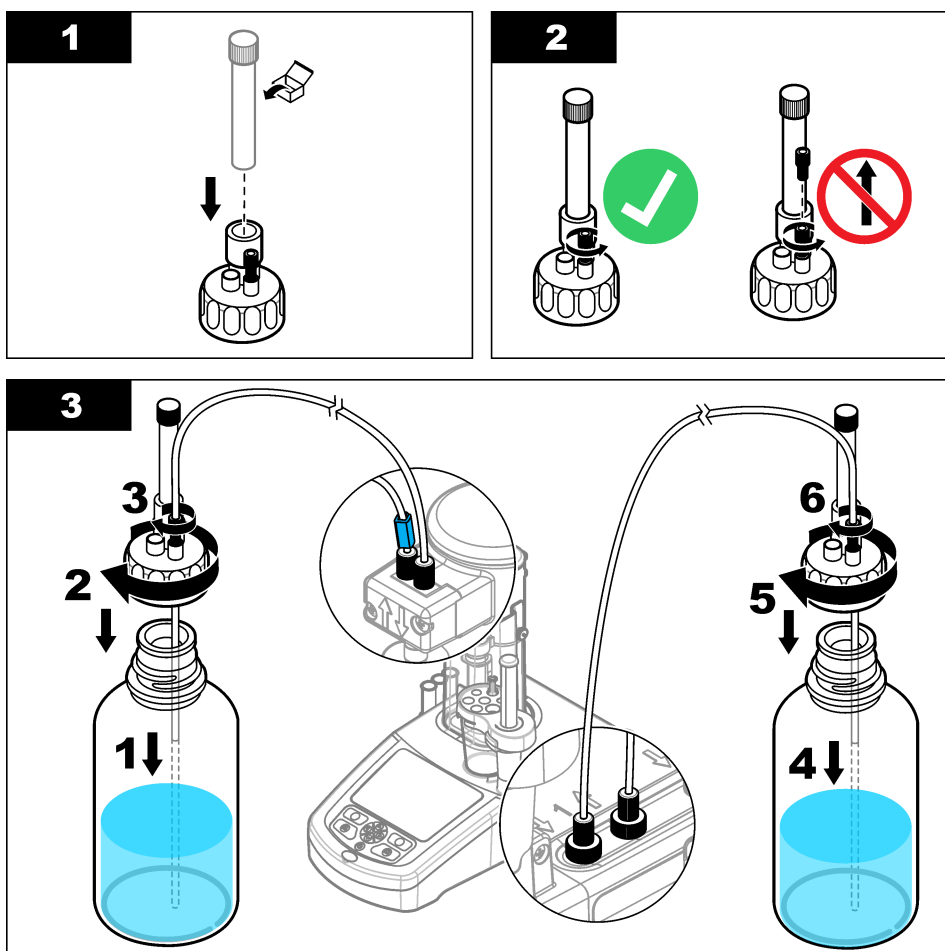

3.10 Tidy the work area

Attach the tubes to the instrument with the clips on the electrovalve and the sensor holder. Refer to the illustrated steps that follow.

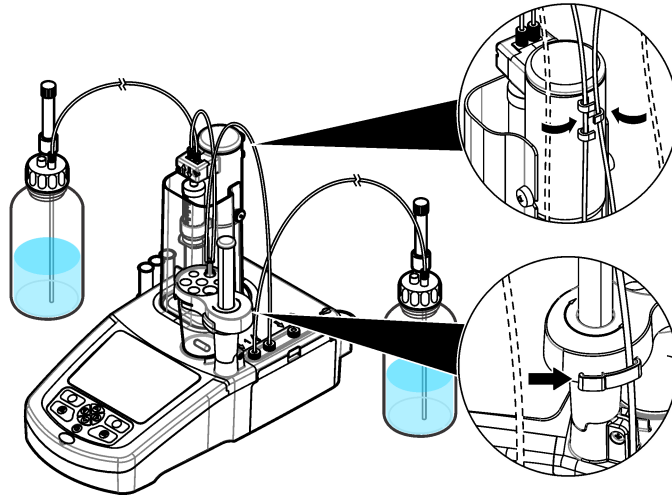

Section 4 Install accessories

4.1 Install an external pump

Table 3 External pump specifications (subject to change without notice)

Specification	Details
Dimensions (W x D x H)	11.4 x 11.4 x 10.0 cm (4.49 x 4.49 x 3.94 in.)
Weight	280 g (0.62 lb)
Power requirements	12 VDC, 0.4–0.54 A
Altitude	2,000 m (6,562 ft) maximum
Operating temperature	15 to 35 °C (59 to 95 °F)
Relative humidity	20 to 80%, non-condensing
Storage temperature	–5 to 40 °C (23 to 104 °F)
Installation category	II
Pollution degree	2
Certifications	EMC IEC/EN 61326-1
Warranty	1 year (EU: 2 years)



NOTICE

The manufacturer is not responsible for any damages due to misapplication or misuse of this product including, without limitation, direct, incidental and consequential damages, and disclaims such damages to the full extent permitted under applicable law. The user is solely responsible to identify critical application risks and install appropriate mechanisms to protect processes during a possible equipment malfunction.

Please read this entire section before unpacking, setting up or operating this equipment. Pay attention to all danger and caution statements. Failure to do so could result in serious injury to the operator or damage to the equipment.

Make sure that the protection provided by this equipment is not impaired. Do not use or install this equipment in any manner other than that specified in this manual.

Read all labels and tags attached to the equipment. Personal injury or damage to the equipment could occur if not observed. A symbol on the equipment is referenced in the manual with a precautionary statement.

	Electrical equipment marked with this symbol may not be disposed of in European domestic or public disposal systems. Return old or end-of-life equipment to the manufacturer for disposal at no charge to the user.
	Products marked with this symbol indicates that the product contains toxic or hazardous substances or elements. The number inside the symbol indicates the environmental protection use period in years.

This accessory (item no. LZE142) is used to remove any excess sample from the beaker to control the volume of sample before titration. The inlet and outlet tubes are pre-installed on the pump. Make sure that the tube from the **outlet** port of the pump is installed in an applicable liquid waste container. A blue tag is attached to the **inlet** tubes that extract the liquid from the beaker.

To install the pump, refer to the illustrated steps that follow. After installation, check that the pump and tubes are correctly installed by selecting **Maintenance > Pump activation** from the instrument home screen (refer to [Pump activation](#) on page 43).

Install accessories

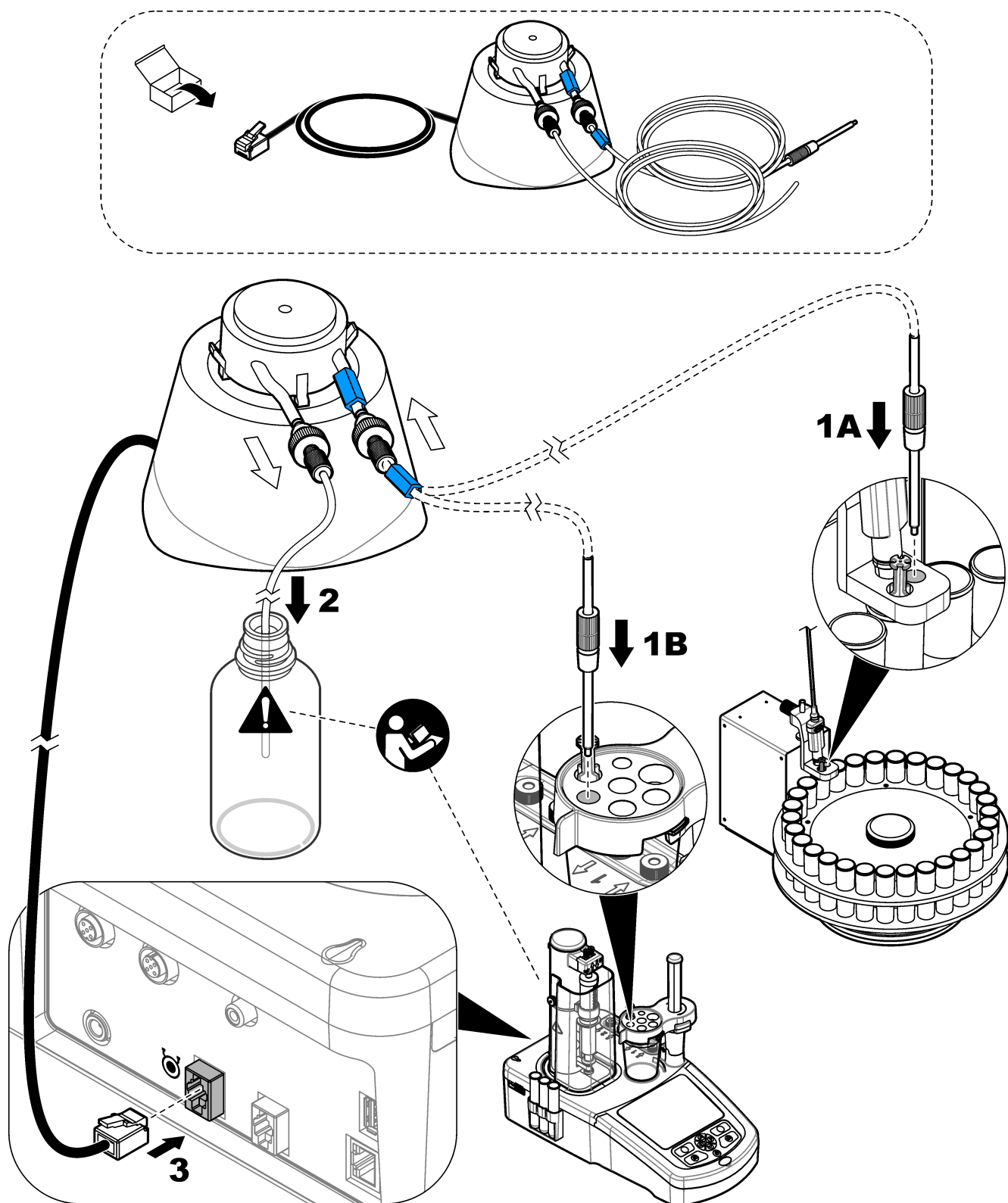

To adjust the height of the tube in the sample, unscrew the top of the fitting and slide the metal tube up or down to the required height before retightening the fitting. Refer to [Figure 3](#).

Figure 3 Tube adjustment

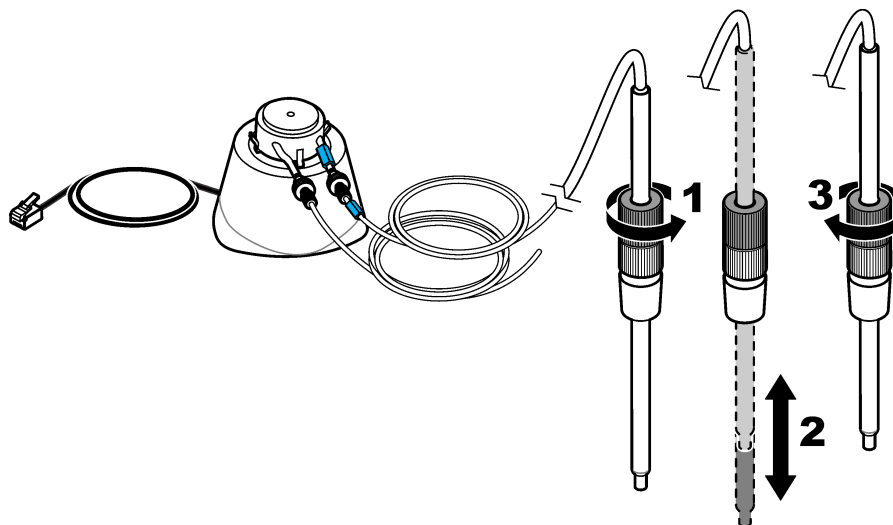

4.2 Install an external propeller

This accessory (Item no. LZE143) is used as an alternative to the standard magnetic stir bar, for more viscous samples.

1. Install the propeller into the slot in the middle of the sensor holder.
2. Connect the propeller to the external propeller port on the rear of the instrument (refer to [Instrument connections](#) on page 8).
3. From the home screen, select Settings>Options. Set the option Propeller Stirrer.

Note: Push the up and down arrow keys to highlight the option. Push the left arrow to set the option ON/OFF then push **Done** to confirm.

4.3 Install a balance

This accessory is used to automatically send accurate weights to the instrument. The balance is a laboratory type balance and uses the RS232 communication protocol with no flow control. When a balance is connected, the window shown at the end of a titration that lets users enter a weight, shows the value from the balance.

The balance automatically sends the weight and unit to the instrument in textual format:

- Messages end with <LF>, <CR> or <LF+CR>
- The numeric value of the weight must be transmitted before the unit of weight
- Allowed units of weight are g, mg and kg
- The unit of weight specifies the end of the data string used by the instrument
- Space characters are ignored

1. Set the RS232 parameters on the balance to:
 - 9600 baud
 - no parity
 - no handshake
 - 8 data bits
 - 1 stop bit
2. Connect the balance to the serial port on the rear of the instrument (refer to [Instrument connections](#) on page 8) using an applicable cable.
3. From the home screen, select **Settings > Options** and make sure that the **Balance** option is checked.

4.4 Install PC software

The optional PC software connects with the TitraLab[®] workstation through an Ethernet network. The software can be used to:

- Control a TitraLab[®] workstation to start and stop analyses
- Control a sample changer to start and stop analyses
- Control a balance for accurate sample weighing
- Show run-time data directly from the workstation
- Manage data stored locally or on a server (search, compare, delete, print, etc.)
- Export data to files for use in other software applications

Full product documentation and on-line help is available with the software.

4.5 Install the syringe verification kit

The optional syringe verification kit enables the verification of the dispensing system based on the ISO8655 standard. The test adds different volumes of liquid on a vessel put on a balance. The weights are used to calculate the real volume added. The real volume is compared with the nominal volume. The results are used to calculate the error in the volume added and the syringe precision. There are three verification modes available:

- Fully automated—The balance is connected to the instrument. The system makes the additions and calculates the results.
- Partially automated—The balance is not connected to the instrument. The user does the balance readings and the system calculates the results.
- Dispense only—The system only makes the additions. The user does the balance readings and calculates the results.

The syringe verification kit includes all of the necessary items: dispensing tips, tubes, syringe holder, pipette holder, support stand, software key and label with the license number. Make sure to keep the label with the license number. A license key is necessary to enable the syringe verification option on the instrument. The first time the option is selected, the instrument shows the MAC address and the Firmware version. Send the MAC address, firmware version and the license number to the manufacturer or a sales representative to get the license key.

Note: *The license key is only necessary when the option is selected for the first time.*

Items to collect:

- Analytical balance with resolution 0.1 mg, repeatability 0.2 mg and uncertainty 0.2 mg
- Temperature sensor
- Deionized water "quality 3" (ISO 3696)

Prepare the syringe verification kit as follows:

1. Put an empty beaker on the balance. Refer to the illustrated steps that follow.
2. For the fully automated mode, connect the balance to the instrument.
3. Install the support stand near the balance. Put the pipette tip adapter above the beaker on the balance.
4. Connect the tube from the pipette holder to the syringe outlet port.
5. Connect the tube from the water bottle to the syringe inlet port.
6. On the instrument, manually enter the temperature. As an alternative, connect and put a temperature sensor on the water bottle to get the temperature automatically.

Note: *The temperature setting is necessary for the fully automated and partially automated modes. The dispense only mode does not adjust the temperature.*

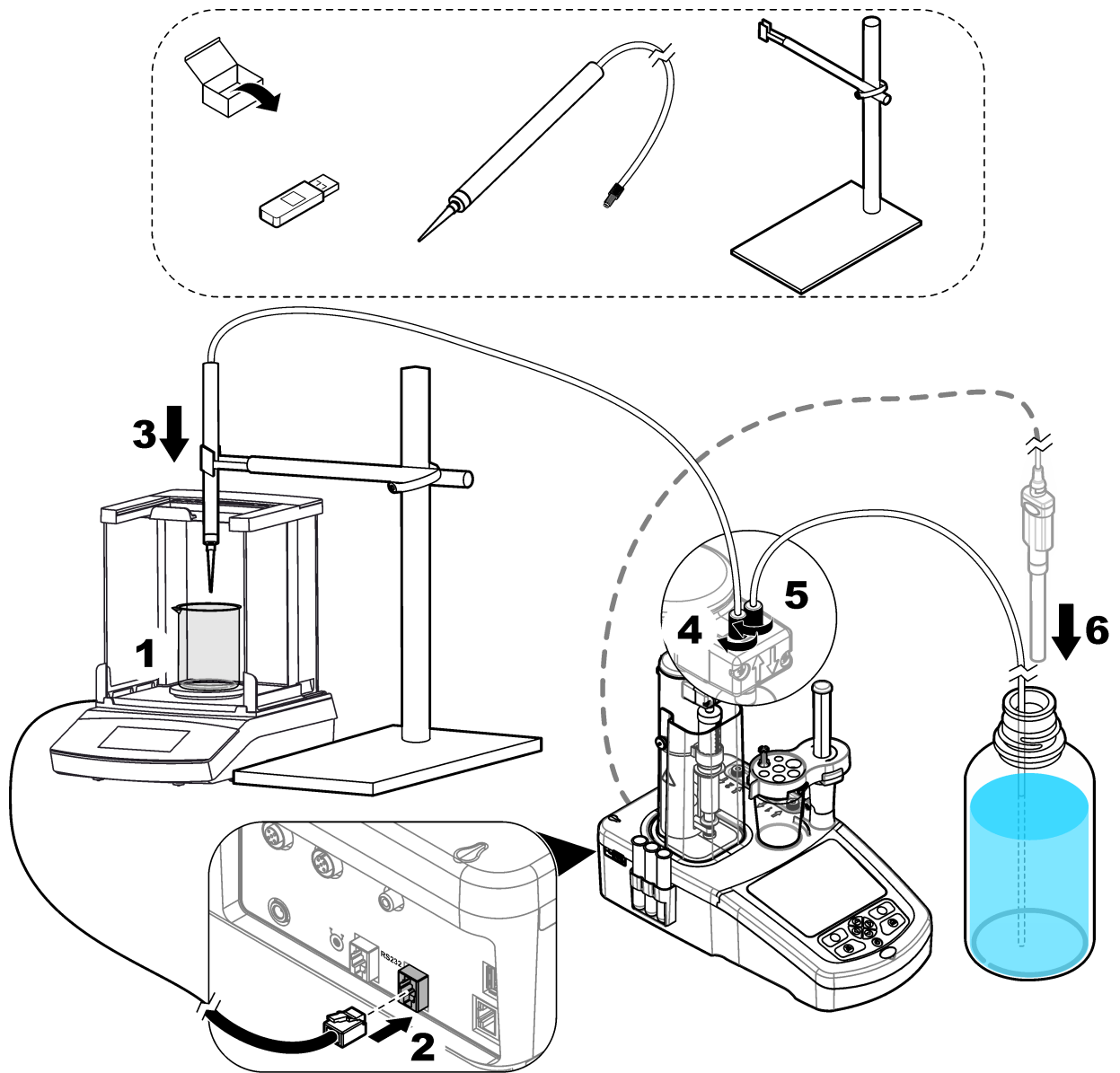

Section 5 User interface and navigation

5.1 Keypad

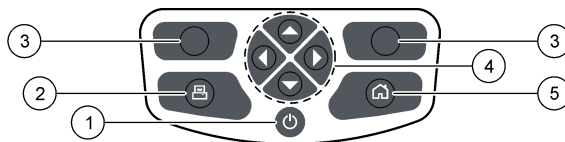

1 Power	3 Selection keys	5 Home key
2 Printer	4 Navigation keys	

Key	Description
Power	Sets the instrument power to on or off. Push the key for 2 seconds to set the power to off.
Printer	The printer key only operates if a printer is connected to the instrument. Sends the data currently shown on the display to a connected printer when pushed. A sound is heard if the current display cannot be printed. A graph is automatically printed at the end of the measurement, if the option is selected (Settings > Options).
Selection keys (contextual)	Used to select options shown above them in the footer bar. The options available are applicable to the current operation (e.g. calibration, measurement, etc.).
Navigation keys	Scrolls through menus and data, enter numbers and letters, enter checkbox settings and set options for the syringe and the pump.
Home	Push this key at any time to go directly to the home screen. A sound is heard if the key is disabled (e.g. during a calibration or measurement).



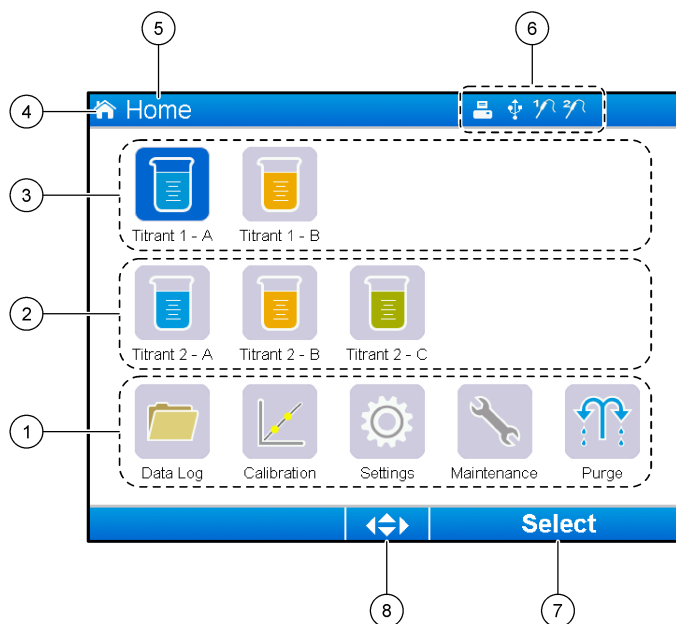



5.2 Home screen



1 Available options from this screen	5 Screen name
2 If two syringes are installed, shows applications for syringe 2	6 Information icons (refer to Table 4)
3 Applications for syringe 1	7 Option available by pushing the selection key below
4 Screen icon	8 Arrow keys available for use in the screen

[Table 4](#) shows the information icons that can be shown in the header bar.

Table 4 Information icons

Icon	Description
	A printer is connected to the instrument
	A USB key is connected to the instrument
	A sensor is connected to sensor port 1
	A sensor is connected to sensor port 2
	The data log file is full. Refer to Manage the data log on page 39 for the options available to manage the data log file.
	A measurement is in operation using the PC software. The keyboard is locked.

5.3 Menu structure

The three primary menus are shown in [Table 5](#), [Table 6](#) and [Table 7](#).

Table 5 Home menu





Option	Description
 Data log	Manage the data log file
 Calibration	Electrode and titrant calibration procedures
 Settings	See the table entry below
 Maintenance	See the table entry below
 Purge	Remove air from the syringe, and from the syringe and pump tubes

Table 6 Settings menu



Option	Description
 Applications	Manage the installed applications
 Operators	Set up and manage the instrument operators
 Date & Time	Set the date and time

Table 6 Settings menu (continued)









Option	Description
 Brightness	Adjust the display brightness
 Sounds	Set the sound on or off for specific operations
 Language	Set the operating language
 Network	Give a name to identify the instrument
 Legacy settings	Specify the legacy sensor data
 Info	Show instrument and attached hardware information
 Restore defaults	Set the instrument to the default configuration
 Options	Set the operating parameters
 Security	Set a password and specify which options are password protected

Table 7 Maintenance menu











Option	Description
 Syringe activation	Make sure that the syringe is working correctly
 Pump activation	Make sure that the pump is working correctly
 Stirring activation	Make sure that the stirrer is working correctly
 Live measure	Quickly check measurement data for connected sensors. Not available for all sensors
 Syringe management	Replace the syringe or change the syringe volume

Table 7 Maintenance menu (continued)

Option	Description
 Pump cassette replacement	Replace the pump cassette for installed pumps
 Reagent replacement	Use this option when replacing reagents
 Maintenance schedule	Manage the maintenance tasks
 Maintenance summary	See the number of days remaining on specified devices before maintenance is required
 Syringe verification	When enabled, starts the syringe verification procedure.

Section 6 Startup

⚠ CAUTION



Chemical exposure hazard. Obey laboratory safety procedures and wear all of the personal protective equipment appropriate to the chemicals that are handled. Refer to the current safety data sheets (MSDS/SDS) for safety protocols.

⚠ CAUTION



Chemical exposure hazard. Dispose of chemicals and wastes in accordance with local, regional and national regulations.

⚠ CAUTION

Personal injury hazard. Never use the instrument without the syringe cover installed.

6.1 Configure the instrument

1. From the home screen, select **Settings**. Refer also to [Menu structure](#) on page 26.
2. Select an option, then push **Select**.

Option	Description
Applications	Changes (refer to Change the application settings on page 38), makes copies, exports and removes application data. Make sure that the duplication function does not make more than five applications for each syringe installed.
Operators	Adds, changes and removes operators.
Date + Time	Sets the instrument date and time.
Brightness	Sets the brightness of the display.
Sounds	Sets the sound options.
Language	Sets the language.
Network	Give a name to the instrument. This name is used to connect the instrument to a PC. If a printer is connected, this name is printed on the hard-copy output. Restart the instrument if the name is changed.
Legacy settings	Specify the sensor data when the legacy adapter is used.
Info	Shows information about the instrument and the attached hardware.
Restore Defaults	Sets the instrument to the default configuration. The restored settings are: <ul style="list-style-type: none">• The language is set to English• All password security is removed• The security password is set to 0000• No sound on: Key press, Information and Analysis results OK• Sound on: Instrument ready, Instrument switch off, Errors and Analysis results not OK• The application parameters view is set to basic mode• Sets the syringe to empty when the instrument is set to off• The temperature display unit is set to °C• No print of the measurement curve• No print of the derivative curves• No balance is connected• No propeller stirrer is connected• The default stirring is set to 10%• The user is set to "Default user"

Option	Description
Options	<p>Sets the following options:</p> <ul style="list-style-type: none">• Set the application parameters view to expert or basic mode• When the instrument is set to off, sets the syringe to empty into the titrant bottle• Changes the temperature display unit• Prints the measurement and derivative curves if a printer is connected• Specify if a balance is connected• Specify if an external propeller stirrer is connected. <p>Note: When the instrument is set to on, the application parameters view is always set to basic mode. Changes made to application data with the instrument in expert mode are kept.</p>
Security	<p>Change the password. Specify which of these options are password protected:</p> <ul style="list-style-type: none">• Settings (all items except Info)• Maintenance schedule and summary• Delete data log• Export data log• Electrode calibration• Titrant calibration• Sample volume calibration• Syringe verification test

3. Push **Back**.

6.2 Install the applications

Use the supplied USB key to install the applications. The instrument can install a maximum of five applications for each syringe installed. For two syringes, the installed applications shown on the top line of the display refer to syringe one and the installed applications shown on the second line refer to syringe two.

If any errors occur during installation, refer to [Troubleshooting](#) on page 49.

1. Push **Home** to go to the main menu.
2. Connect the USB key to the USB port on the side of the instrument. The applications on the USB key show on the display.
3. Push the arrow keys to highlight and select an application to install. Push the left or right arrow key to select it. Do this step again to select additional applications to install.
4. Push **Import** to install the selected applications.
5. Push **OK** to complete the installation. The installed applications show on the home screen.

Note: To install more applications, push **Home** to go to the home screen, then remove the USB key and reconnect it.

6.3 Prepare the instrument for measurement

1. From the home screen, select **Purge**. All attached devices are listed.
2. Select **All elements** to purge all the attached devices, or select one device to purge. Push **Select**. Air is removed from the device and filled with liquid from the bottle.
3. Push **OK** when the operation has completed.
4. Make sure that there are no air bubbles in the device. Do step 2 again if there are any air bubbles.

5. Select the next device to purge if individual devices are being selected.
6. Push **Exit** when all the tubes are filled with reagent and the device has no air bubbles.
Note: If a few small air bubbles can be seen on the inner wall and/or piston of the syringe, they can be left without effecting system performance.

Section 7 Standard operations

⚠ CAUTION



Multiple hazards. Only qualified personnel must conduct the tasks described in this section of the document.

⚠ CAUTION



Chemical exposure hazard. Obey laboratory safety procedures and wear all of the personal protective equipment appropriate to the chemicals that are handled. Refer to the current safety data sheets (MSDS/SDS) for safety protocols.

⚠ CAUTION



Chemical exposure hazard. Dispose of chemicals and wastes in accordance with local, regional and national regulations.

⚠ CAUTION

Personal injury hazard. Never use the instrument without the syringe protection cover in place.

⚠ CAUTION

Chemical exposure hazard. Never remove the stir bar from the beaker before the end of a titration.

7.1 Calibration

7.1.1 Calibrate the sensor

1. From the home screen, select **Calibration**, then push **Electrode calibration**.
2. If more than one sensor is installed, push the up and down arrow keys to highlight the sensor to use, then push **Select**.
3. If more than one application includes calibration parameters for the sensor, push the up and down arrow keys to highlight the application to use, then push **Select**. Calibration information shows on the display.
4. If necessary, select an icon for more information or to change some data.

Option	Description
Electrode	Shows more information about the sensor.
Operator	Changes the operator ID. Select from a list of applicable operators.
Buffer or Standard	Shows more information about the buffer set or standard.

5. Do the instructions that show on the display, then push **Start** to start the calibration. Calibration data shows on the display.
6. If the default stirring speed needs to be adjusted, push the up and down arrow keys to increase or decrease the speed.
Note: This adjustment only applies to the current operation. The standard default stirring speed for the calibration is not changed.
7. Select **Stop** at any time to stop the calibration. Results are then calculated from the calibration data available before **Stop** is selected.

- For pH sensors only:

Option	Description
--------	-------------

- | | |
|------------|---|
| Yes | Continue with the next calibration buffer solution in the sequence. |
| No | Stop the calibration. The calibration can still be validated if at least one buffer calibration was successful. |

- When the calibration is complete, push the left and right arrow keys to see the different measurement views.
- Push **Reject** or **Validate**.

Option	Description
--------	-------------

- | | |
|---------------|--|
| Reject | Select Cancel to go back to the result display or Confirm to reject the calibration and use the default or previous calibration value. |
|---------------|--|

Validate The calibration is accepted and the new values stored.

7.1.2 Calibrate the titrant

- From the home screen, select **Calibration**, then push **Titration calibration**.
- If more than one titrant is installed, push the up and down arrow keys to highlight the titrant to calibrate, then push **Select**.
- If more than one application contains a titration calibration method, push the up and down arrow keys to highlight the application to use, then push **Select**.
- Calibration information shows on the display. If necessary, select an icon for more information or to change some data.

Option	Description
--------	-------------

Information	Shows more information about the calibration.
--------------------	---

Operator	Changes the operator ID. Select from a list of applicable operators.
-----------------	--

- Fill a beaker with the recommended standard amount that shows on the display. If necessary, add more of the solvent specified in the application note until the sensor is correctly installed in the sample.
- Carefully put a magnetic stir bar into the beaker. Make sure there is no liquid spill.
- Attach the beaker to the sensor holder.
- Make sure that the icon at the bottom of the display  is highlighted. Do the instructions that show on the display adjacent to this icon. Refer to [Connect the sensor](#) on page 15 to make sure that the tubes and sensor are correctly aligned.
- Push **Start** to start the calibration. Calibration data shows on the display.
- If the default stirring speed needs to be adjusted, push the up and down arrow keys to increase or decrease the speed.

Note: This adjustment only applies to the current operation. The standard default stirring speed for the application is not changed.

11. Two options are available during the procedure:

Option	Description
Stop	Aborts the calibration and no results are calculated. If selected during the Replicate Sample option, then all data in the series is lost.
Skip	Stops the current operation and goes directly to the next step in the procedure. Results are then calculated from calibration data available before Skip is selected. Results can be less accurate using this option.

12. Push **Reject** or **Continue**.

Option	Description
Reject	Rejects the calibration. Select Cancel to go back to the result display or Confirm to reject the calibration. If this is the first calibration, select Confirm to reject the calibration and use the default or previous calibration values. If this is a Replicate Standard calibration, select Confirm to reject only the current calibration in the series.
Continue	Select from one of these options: <ul style="list-style-type: none"> • Replicate Standard: Do the calibration again using the same standard • Save & Exit: Keep the calibration results and exit the calibration procedure • Reject & Exit: Reject the calibration results and use the default or previous calibration values, and exit the calibration procedure

7.1.3 Auto leveling calibration

This option is only available when at least one installed application contains an auto leveling calibration method and the method is set to active. The calibration makes sure that the sample volume in the measurement cell is the same before each titration.

An external pump must be installed for this procedure.

1. From the home screen, select **Calibration**, then push **Autoleveling calibration**.
2. If more than one application contains an auto leveling calibration method, push the up and down arrow keys to highlight the application to use, then push **Select**.
3. Calibration information shows on the display. If necessary, select an icon for more information or to change some data.

Option	Description
Information	Shows more information about the calibration.
Operator	Changes the operator ID. Select from a list of applicable operators.

4. Make sure that the external pump and tubes are correctly installed (refer to [Install an external pump](#) on page 19).
5. Make sure that the sensor, tubes and stir bar are correctly installed in an empty beaker, as if preparing for a standard measurement.
6. Accurately measure the necessary volume of sample and pour it into the empty beaker.
7. Adjust the position of the tube from the external pump (refer to [Figure 3](#) on page 21) so that it touches the surface of the liquid. Then add more sample until the end of the tube is immersed in 5 to 10 mm of the liquid.
8. Push **Start** to start the calibration.
9. The leveling procedure starts and sample is removed for the preset time. Make sure that this time is large enough for all the necessary sample to be removed and for air to be removed for some seconds at the end.

10. The titration measurement starts after the leveling procedure completes. If the default stirring speed needs to be adjusted, push the up and down arrow keys to increase or decrease the speed.

Note: This adjustment only applies to the current operation. The standard default stirring speed for the calibration is not changed.

11. Two options are available during the calibration procedure:

Option	Description
--------	-------------

Stop	Aborts the calibration and no results are calculated. If selected during a Replicate Standard calibration, then all data in the series is lost.
-------------	--

Skip	Stops the leveling operation and goes directly to the next step in the procedure. Results are then calculated from the data available before Skip is selected.
-------------	---

12. When the calibration is complete, push the left and right arrow keys to see the different measurement views. The result of the titration is the calculated volume of sample.

13. Push **Reject** or **Continue**.

Option	Description
--------	-------------

Reject	Rejects the calibration. Select Cancel to go back to the result display or Confirm to reject the calibration. If this is the first calibration, select Confirm to reject the calibration and use the default or previous calibration values. If this is a Replicate Standard calibration, select Confirm to reject only the current calibration in the series.
---------------	---

Continue	Select from one of these options:
-----------------	-----------------------------------

- **Replicate Standard:** Do the calibration again using the same sample
- **Save & Exit:** Keep the calibration results and exit the calibration procedure
- **Reject & Exit:** Reject the calibration results and use the default or previous calibration values, and exit the calibration procedure

14. If the calibration is successful, the calculated volume of sample is kept in the application parameters. This value is shown in the measurement start view for that application and is used in the next titration calculations of the application.

7.2 Sample preparation

When this application is installed (refer to [Install the applications](#) on page 30), use it to prepare one or more measurement samples.

Note: If the PC software is installed (refer to [Install PC software](#) on page 22) and the AS1000 sample changer is installed, sample preparation can be done with or without leveling. But if the sample preparation is done without the software and sample changer, then leveling must be deactivated (Active = No). It is recommended to read the related "Application Note" from the USB applications key for more instructions.

1. From the home screen, select the sample preparation application, then push **Select**.
2. Make sure that the reagent used to prepare the sample is installed with the correct pump.

Note: The application parameters can be changed in basic or expert mode. Refer to [Change the application settings](#) on page 38.

3. Obey the instructions on the display.
4. Push **Next** to prepare more samples or **Exit** to go back to the home screen.

7.3 Get a sample measurement

Use this option to get sample measurements with one of the installed applications.

1. From the home screen, select the measurement application, then push **Select**. Application information shows on the display.
2. Read the related "Application Note" from the USB applications key for more instructions.
3. If necessary, select an icon for more information or to change some data.

Option	Description
Information	Shows more information about the application.
Operator	Changes the operator ID. Select from a list of applicable operators.
Sample	Sample Name: Change the specified name of the sample. Type: Push the left and right arrow keys and select the sample type (Sample , QC or Define blank) to be used for the measurement. If Define blank has been selected before, two more sample types are available (QC with blank and Sample with blank).

4. Fill a beaker with the recommended sample amount that shows on the display. If necessary, add more of the solvent specified in the application note until the sensor is correctly installed in the sample.
5. Carefully put a magnetic stir bar into the beaker. Make sure there is no liquid spill.
6. Attach the beaker to the sensor holder.
7. Make sure that the icon at the bottom of the display  is highlighted. Do the instructions that show on the display adjacent to this icon. Refer to [Connect the sensor](#) on page 15 to make sure that the tubes and sensor are correctly aligned.
8. Push **Start** to start the measurement. Measurement data shows on the display.
9. If the default stirring speed needs to be adjusted, push the up and down arrow keys to increase or decrease the speed.
Note: This adjustment only applies to the current operation. The standard default stirring speed for the application is not changed.
10. Two options are available during the procedure:

Option	Description
Stop	Aborts the measurement and no results are calculated. If selected during the Replicate Sample option, then all data in the series is lost.
Skip	Stops the current operation and goes directly to the next step in the procedure. Results are then calculated from measurement data available before Skip is selected. Results can be less accurate using this option.

11. When the measurement is complete, push the arrow keys to see the different measurement views.
12. Push **Next** for these options:

Option	Description
Replicate Sample	Use this option to start the same titration on the same sample. This is used to study the repeatability by successively analyzing several parts of the same sample. At the end of each measurement, a window shows the average value, the standard deviation and the relative standard deviation.
New Sample	Use this option to start the same titration on a new sample. No standard deviation or relative standard deviation measurements will be done.

13. Push **Exit** to go back to the home screen.

7.4 Change the application settings

NOTICE

The applications installed on the instrument have been pre-defined to optimize the measurement process. Changing these default application parameters will have an effect on the measurement process and measurement results. Only qualified personnel should change these parameters or use the instrument in **Expert mode**. Refer to the application note before changing any parameters.

NOTICE

In **Basic mode** changes to parameters are secure. In **Expert mode** changes to parameters are not secure and can cause the application to run incorrectly.

Refer to [Change application parameters](#) on page 63 for a list of parameters that can be changed in basic and expert mode.

Refer to [Sample name](#) on page 38 for special features on the sample name.

1. From the home screen, select **Settings**.
2. Select **Applications** followed by **Edit**.
3. If more than one application is installed, choose an application to change from the installed list and then push **Edit**.
4. Push the left and right arrow keys to jump to the previous or next parameter group. Push the up and down arrow keys to scroll through the application parameters in the parameter group.
5. The **Edit** key is only available when a parameter can be changed. Push **Edit** to change the parameter. Enter the new details or select from a list.
Note: A description of the selected parameter is shown on the bottom of the display.

7.4.1 Sample name

The two wildcard characters ? (question mark) and * (asterisk) can be used to automatically increment the sample name.

Use the question mark character to increment the name using an integer. For example, where **Water** is the name of the sample:

- Select **Settings > Applications > Edit** and change the sample name to **Water ?**
- The sample name for the first measurement is **Water 1**
- The sample name for the next measurement is **Water 2**, etc.
- The integer value is always set back to 1 when the instrument is set to off

Use the asterisk character in the name to increment the name using the instrument date and time in **YYMMDDHHMMSS** format. For example, where **Water** is the name of the sample:

- Select **Settings > Applications > Edit** and change the sample name to **Water ***
- The sample name for the first measurement made on 27th February 2015 at 15:30:25 is **Water 150227153025**
- The sample name for the next measurement made on 28th February 2015 at 16:32:47 is **Water 150228163247**, etc.
- The value is not reset when the instrument is set to off

Use both characters in the name to increment the name using an integer and the instrument date and time. For example, where **Water** is the name of the sample:

- Select **Settings > Applications > Edit** and change the sample name to **Water ? ***
- The sample name for the first measurement made on 27th February 2015 at 15:30:25 is **Water 1 150227153025**

- The sample name for the next measurement made on 27th February 2015 at 17:01:27 is **Water 2 150227170127**, etc.
- The integer value is always set back to 1 when the instrument is set to off

7.5 Manage the data log

To select data to view, delete or export, specify data filters

1. From the home screen, select **Data log**.
2. Select an option, then push **Select**.

Option	Description
View data log	Views measurement data. Select individual lines of data to view more content.
Export data log	Exports measurement data from the system to an external device. Preview data selection before it is exported. Make sure that an external device is connected to the instrument (e.g., a USB key, external hard drive, etc.).
Delete data log	Removes measurement data from the system. Previews data selection before it is removed.

3. Specify the data selection parameters. Push the left and right arrow keys to make a selection. Push the up and down arrow keys to select an option.

Option	Description
Result type	Sets the type of result available.
Application	Sets the available applications.
Date	Sets the date range.
Operator	Sets the available operators.

4. If **View data log** was the selected option, push **View** to see the selected data.
 - Push the up and down arrow keys to select a line of data and push **Detail** to see more data
 - If **Electrode calibration** is selected as the **Result type**, push the left and right arrow keys to select the sensor if more than one sensor is installed. Push the up and down arrow keys to select a line of data, then push the left and right arrow keys to see related graphs
 - If only one **Application** is selected push the up and down arrow keys to select a line of data and push **Detail** to see more data, or push the left and right arrow keys to see related graphs
5. If **Export data log** or **Delete data log** was the selected option, push **Preview** to see the selected data, then push **Export** or **Delete** to start the procedure.

7.6 Purge

Use this procedure to remove air bubbles from the system. Refer to [Prepare the instrument for measurement](#) on page 30 for instructions.

Section 8 Maintenance

⚠ CAUTION



Multiple hazards. Only qualified personnel must conduct the tasks described in this section of the document.

NOTICE

Do not disassemble the instrument for maintenance. If the internal components must be cleaned or repaired, contact the manufacturer.

8.1 Maintenance schedule

Table 8 shows the recommended schedule of maintenance tasks. Facility requirements and operating conditions may increase the frequency of some tasks.

Table 8 Maintenance schedule

Task	1 day	7 days	12 months
Clean the instrument on page 41. Also do this procedure immediately after any liquid spills on the instrument.	x		
Clean the sensor on page 41.		x	
If applicable, Replace desiccant cartridge contents on page 42.		x	
Replace the syringe. Refer to Syringe management on page 43.			x
Replace syringe electro-valve block. Refer to Replace the syringe electro-valve block on page 42.			x
Examine the syringe connections and inlet and outlet tubes for leaks and damage. Replace as necessary. Refer to Replacement parts and accessories on page 57 for part numbers and to Replace the tubes on page 42.			x
Replace the pump cassettes. Refer to Pump cassette replacement on page 44.			x
Examine the pump connections and inlet and outlet tubes for leaks and damage. Replace as necessary. Refer to Replacement parts and accessories on page 57 for part numbers and to Replace the tubes on page 42.			x
Examine the bottle caps and connections for leaks and damage. Replace as necessary. Refer to Replacement parts and accessories on page 57 for part numbers.			x

8.2 Clean the instrument

NOTICE

Never use flammable or corrosive solvents to clean any part of the instrument. Use of these solvents can degrade the environmental protection of the instrument and may void the warranty.

Clean the exterior surface with a moist cloth or with a mixture of water and mild detergent. Dry with a soft cloth.

8.3 Clean the sensor

Obey the cleaning instructions given in the documentation supplied with the sensor, and any other instructions given in the application note.

8.4 Replace the tubes

After installing a new tube, make sure that it is correctly installed by turning the tube connectors on the inlet and outlet ports of the syringe or pump until they click. Refer also to [Connect the tubes](#) on page 14.

8.5 Replace desiccant cartridge contents

When used, it is recommended to replace the desiccant cartridge contents weekly, but this will vary depending on the humidity of the laboratory. A humidity indicator, such as color changing silica gel crystal, can be used to show when replacement is necessary.

8.6 Replace the syringe electro-valve block

⚠ DANGER	
	Electrocution hazard. Remove power from the instrument before this procedure is started.
NOTICE	
It is recommended that this procedure is only done by a qualified service engineer.	

Refer to the illustrated steps that follow.

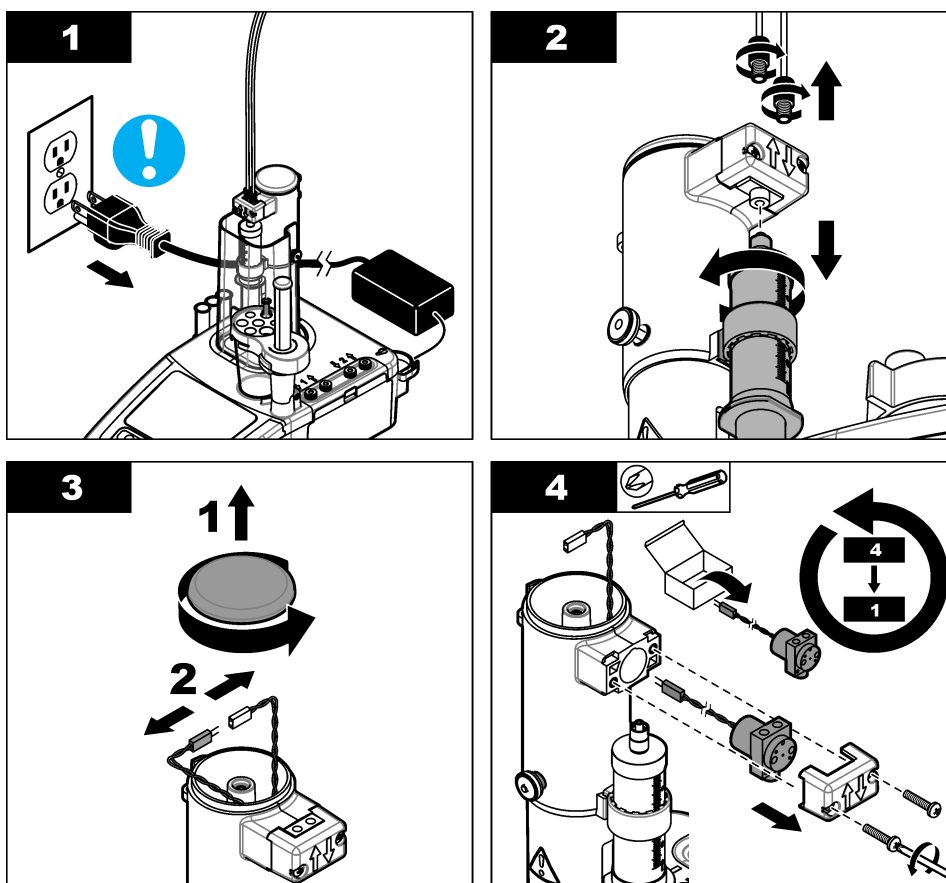

8.7 Maintenance menu

Select **Maintenance** from the home screen.

Refer also to [Table 7](#) on page 27.

8.7.1 Syringe activation

Do a check of the syringe. Make sure the syringe fills and empties correctly.

1. From the maintenance menu, push **Syringe activation**. Push the arrow keys to select an option.

Option	Description
Fill	Fills the syringe with titrant solution. The process stops automatically when the syringe is full.
Empty to bottle	Discards the contents of the syringe into the titrant bottle.
Empty to beaker	Discards the contents of the syringe into the beaker. Make sure that the tube from the outlet port of the syringe is inside the beaker.
Stop	Stops the operation.

If a second syringe is installed, the **Toggle** option is shown on the display. Push **Toggle** to change to the second syringe, or to operate both syringes.

8.7.2 Pump activation

This option only applies to instruments with pumps installed. Do a check of the pump. Make sure the pump fills and empties correctly.

1. From the maintenance menu, push **Pump activation**. Push the up and down arrow keys to select an option.

Option	Description
Start	Starts the pump. The reagent is pumped through the tubes into the beaker. Make sure that the tube from the outlet port of the pump is in the beaker.
Stop	Stops the operation.

If more than one pump is installed, the **Toggle** option is shown on the display. Push **Toggle** to change to the second pump, to an external pump or to operate all pumps.

8.7.3 Syringe management

Use this option to replace the syringe, or change the syringe volume.

1. From the maintenance menu, push **Syringe management**.

Option	Description
Syringe replacement	If two syringes are installed, select the syringe to replace. Select to discard the contents of the syringe into the titrant bottle or the beaker, and then obey the instructions on the display. Refer also to Install the syringe on page 12 for the installation.
Syringe volume change	If two syringes are installed, select the syringe to change. Select the new syringe volume.

8.7.4 Syringe verification

Use the syringe verification option to examine the syringe accuracy based on the ISO 8655 standard. For the best results, follow the procedure in the application note supplied with the syringe verification kit.

Note: A license key is necessary to enable the syringe verification option on the instrument. Contact the manufacturer or a sales representative to get a license key.

1. From the home screen, select Settings, then push **Select**.
2. From the settings screen, select Options, then push **Select**.

3. Push the left or right arrow key to select the expert mode, then push **Done**.
4. From the home screen, select Maintenance, then push **Select**.
5. From the maintenance screen, select Syringe verification, then push **Select**.
Note: When the option is selected for the first time, enter the license key.
6. Push the up and down button to select and change the syringe test options.

Option	Description
Syringe	Selects the syringe. Used when there are two syringes. Shows the syringe information: syringe number and volume.
Operator	Selects the operator ID
Configuration	Sets the test settings: test volume and number of replicates. The total dispensed liquid for the test shows when the two parameters are set. <i>Note: Make sure to use the applicable beaker and balance for the test based on the amount of total dispensed liquid.</i> A field to write the test conditions is available in the test conditions settings.
Start	Starts the syringe verification procedure.

7. Push Start to start the syringe verification procedure. Follow the procedure supplied with the syringe verification kit.
8. To cancel the syringe verification test and not save data to the data log, push Stop.
9. To cancel the syringe verification test and save the syringe verification results for fully tested volumes to the data log, push Skip.
10. When the test is complete Pass or Fail shows. Push the left or right arrow to show the results for the different volumes. Push the up and down arrow to show more results data for the selected volume.

8.7.5 Pump cassette replacement

 DANGER	
	Electrocution hazard. Remove power from the instrument before this procedure is started.

This option only applies to instruments with pumps installed.

To replace the pump cassette, refer to the illustrated steps that follow and obey the instructions on the display.

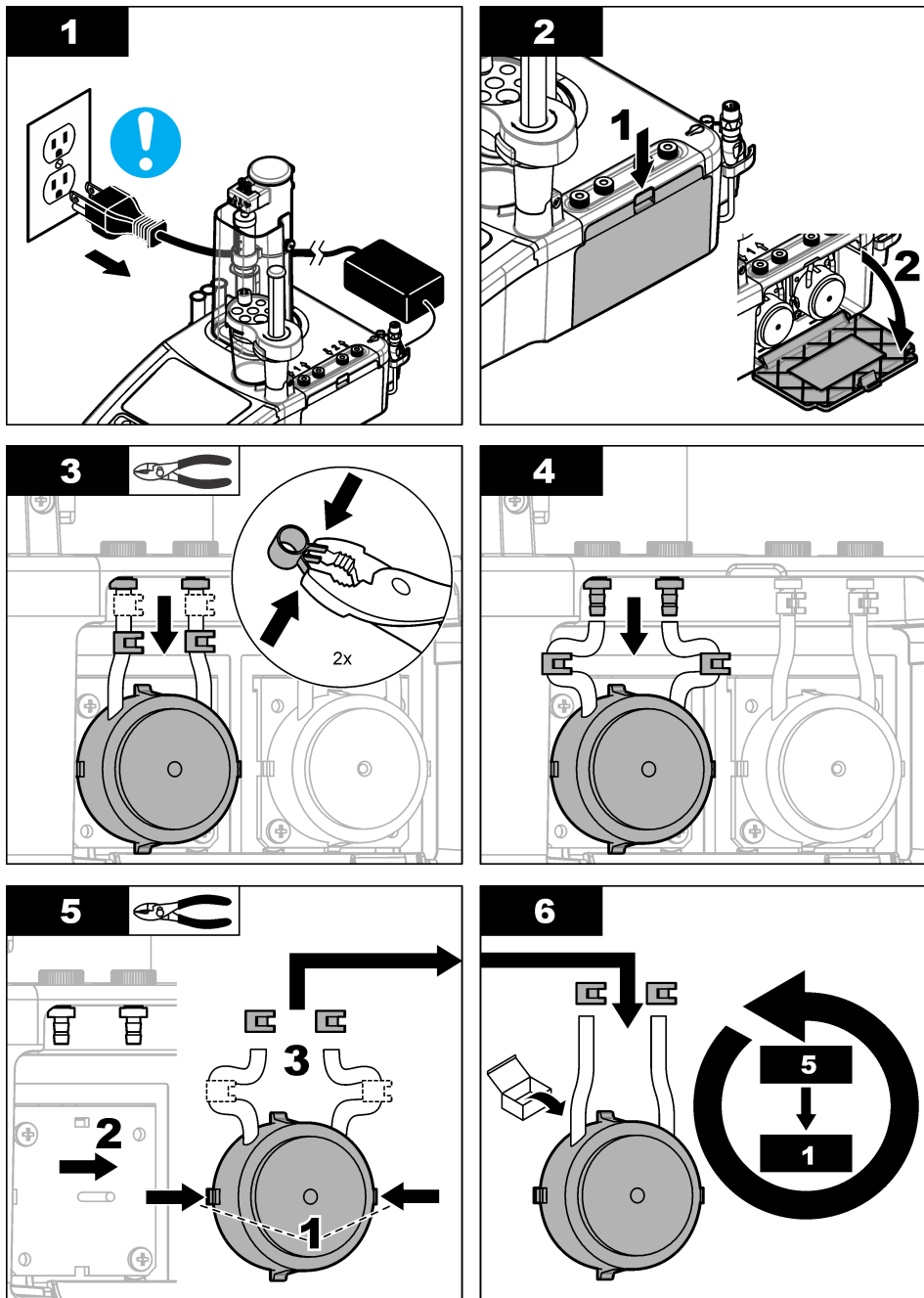

8.7.6 Other maintenance options

1. Select an option, then push **Select**.

Option	Description
Stirring activation	Do a check of the magnetic stirrer. Push the up and down arrow keys to increase or decrease the stirring speed.

Option	Description
Live measure	This option is not available for all sensors. The option shows continuous measurement data with connected sensors to quickly check measurements. The installed applications and the automatic additions to the sample are set to off. Continuous measurements are not temperature compensated, so measurement differences may occur in the same sample between continuous measurements and measurements that use installed applications with temperature compensation.
Reagent replacement	Use this option to replace the reagents. Obey the instructions on the display.
Maintenance schedule	See the list of maintenance tasks. Push Edit to change the default value.
Maintenance summary	See the number of days remaining for maintenance tasks. After doing a task, push Reset to set the number of days remaining to the default value.



8.8 Storage and transportation

8.8.1 Prepare the instrument for storage

⚠ CAUTION	
	Chemical exposure hazard. Obey laboratory safety procedures and wear all of the personal protective equipment appropriate to the chemicals that are handled. Refer to the current safety data sheets (MSDS/SDS) for safety protocols.
⚠ CAUTION	
	Chemical exposure hazard. Dispose of chemicals and wastes in accordance with local, regional and national regulations.

1. Remove the sensor from the sensor holder and disconnect it from the sensor port on the rear of the instrument.
2. Clean the sensor. Refer to [Clean the sensor](#) on page 41.
3. Put the sensor in a storage tube that contains a storage solution. Refer to the sensor documentation for storage instructions.
4. From the home screen, select **Maintenance > Syringe activation** and empty the contents of the syringe.
5. If a second syringe is installed, push **Toggle** to select it and empty the contents.
6. Set the instrument power to off.
7. Carefully remove the tubes from the titrant bottle. If pumps are installed, remove the tubes from the reagent bottles. Seal the bottles with the original bottle cap.
8. Flush the tubes with water or an applicable cleaning solution (refer to the application note for more information).
9. Drain the used beakers and clean with deionized water.
10. If storing the instrument for more than a week, remove the syringe from the instrument (refer to [Install the syringe](#) on page 12). Flush the syringe with water or an applicable cleaning solution and store in its box.

8.8.2 Prepare the instrument for short-term storage

⚠ CAUTION	
	Chemical exposure hazard. Obey laboratory safety procedures and wear all of the personal protective equipment appropriate to the chemicals that are handled. Refer to the current safety data sheets (MSDS/SDS) for safety protocols.
⚠ CAUTION	
	Chemical exposure hazard. Dispose of chemicals and wastes in accordance with local, regional and national regulations.

Use this procedure if storing the instrument overnight or over a weekend.

1. Carefully clean the measurement cell using an applicable organic solvent to dissolve any residue and oil.
2. Fill the measurement cell with a new working medium.
3. Add titrant to the working medium until it becomes brown in color.
4. Check that the measurement cell is tightly installed.
5. Check the position of all the elements in the sensor holder.
6. Set the instrument power to off.

8.8.3 Prepare the instrument for shipment

1. Refer to [Prepare the instrument for storage](#) on page 46.
2. Put the instrument and the necessary accessories in a package with all the packaging materials.
3. Ship the instrument at a temperature -5 to 40 °C (23 to 104 °F) and relative humidity up to 80%.
4. Make sure that the storage location for the instrument does not have dust, condensation or chemical evaporation.

Section 9 Troubleshooting

Refer to the following tables for problem messages and possible causes and solutions.

Table 9 Measurement

Error/Warning	Description	Possible solution
Measurement unstable	The measurement from the sensor is not stable	Make sure that there are no bubbles around the sensor element or junction
Measurement out of range	The sample concentration is outside the sensor measurement limits	Adjust the sample preparation to be inside the sensor measurement range
		Use a different sensor with a more applicable measurement range
Temperature out of range	The sample temperature is outside the sensor measurement limits	Adjust the sample temperature to be inside the sensor measurement range
		Use a different sensor with a more applicable measurement range
		Make sure that the sensor is operating correctly
Max. ordinate reached	The titration is stopped because the measured signal is above or below the ordinate stop point set for this application, depending on the curve direction	Refer to the application note for best practices and do the titration again
		Adjust the maximum ordinate for the application (refer to Change application parameters on page 63)
Below minimum range	This message is specific to amperometric applications; the equivalence point has not been found	Select an application range more adapted to the sample
Above maximum range	This message is specific to amperometric applications; the equivalence point has not been found	Select an application range more adapted to the sample
Insufficient curve resolution	This message is specific to amperometric applications; the equivalence point has not been found	Refer to the application note for best practices and do the titration again
		Clean the sensor using the recommended procedures in the sensor documentation
Not enough excess titrant	This message is specific to amperometric applications with back titration; the equivalence point has not been found	Refer to the application note for best practices and do the titration again
		Check the excess titrant defined in the application file and adjust if necessary or select an application range more adapted to the sample
Too much excess titrant	This message is specific to amperometric applications with back titration; the equivalence point has not been found	Refer to the application note for best practices and do the titration again
		Check the excess titrant defined in the application file and adjust if necessary or select an application range more adapted to the sample
Flat signal	The titration is stopped because the amount of sample is below the detectable limit of the application	Refer to the application note for best practices and do the titration again
		Select an application range more adapted to the sample
Analysis skipped	The titration has been stopped manually by the user; the equivalence point has not been found	Preferably use an automatic end titration detection instead of a manual skip

Table 9 Measurement (continued)

Error/Warning	Description	Possible solution
Equiv. point not found	The titration fails to determine the equivalence point	Refer to the application note for best practices and do the titration again
		Adjust the equivalence point detection value for the application (refer to Change application parameters on page 63)
		Contact technical support
Out of range	The computed result is outside the accepted limits	Refer to the application note for best practices and do the titration again
		Adjust the result minimum and maximum values for the application (refer to Change application parameters on page 63)
Equation calc. error	An equation variable is unknown (e.g. the ordinate of the equivalence point is unknown or the volume of the equivalence point is unknown)	Make sure that all the equation variables are available (refer to the application note for the equation description and values)
A required electrode is not connected!	The applicable IntelliCAL electrode type for the application is not connected.	Connect the IntelliCAL electrode specified in the application note.
Application {application name} Electrode: Type: {type}: Name: {name}:	The "Sensor name" set in the legacy adapter settings does not agree with application settings.	Change the "Sensor name" setting in the legacy adapter setting to agree with the sensor name specified in the application note.
Electrode calibration has expired	A titration or titrant calibration has been done with an expired sensor calibration date	Calibrate the sensor and if necessary adjust the calibration frequency (refer to the application note for the recommended frequency)
Titrant calibration has expired	A titration has been done with an expired titrant calibration date	Calibrate the titrant and if necessary adjust the calibration frequency (refer to the application note for the recommended frequency)
The titrant used by an application has been modified and this application became incompatible with applications already installed. Please go to application management to solve the issue	The application data has been changed and the application cannot be used	Remove the application or change the titrant to a titrant that is already installed
System error	A system error causes the titration to stop (e.g. a sensor has been disconnected or the volume of reagent is too low)	Make sure that all the system elements are connected and working correctly (refer to Maintenance menu on page 42)
Max. vol. reached	The titration is stopped because the supplied volume of reagent is more than the maximum quantity	Refer to the application note for best practices and do the titration again
		Adjust the maximum volume stop point for the application (refer to Change application parameters on page 63)
No titrant information	There is no description of the titrant	Install the application again

Table 9 Measurement (continued)

Error/Warning	Description	Possible solution
No measure received	No measurement can be done	Make sure that the sensor is correctly connected to the instrument
		Disconnect the sensor and connect it again
		Change the sensor if no measurement is received using the Live Measure option (refer to Other maintenance options on page 45)
The stirrer/propeller stirrer does not operate	The stirrer (or the propeller stirrer) does not automatically start when the measurement starts.	Make sure that the stirrer configuration is set correctly. Identify if the applicable stirrer is selected in the Settings>Options menu.
Printer: communication error	The red LED on the printer flashes to show that the printer is in error mode. There is no paper in the printer.	Replace the paper roll in the printer. Refer to the printer documentation.
Burette fails to deliver	Syringe cannot deliver any reagent	Contact technical support
Burette fails to fill	Syringe cannot be filled with reagent	Contact technical support
Burette failed to read delivered volume	Syringe cannot calculate the delivered volume of reagent	Contact technical support
System failure	Operational failure	Contact technical support

Table 10 Calibration

Error/Warning	Description	Possible solution
Temperature variation too high	The variation in temperature is too high across all the calibration solutions when more than one is used	Make sure that the maximum temperature variation across all the calibration solutions is no more than 5 °C before starting a calibration
Temperature out of range	The temperature of the calibration solution is outside the specified temperature range for the buffer or standard used in the calibration	Make sure that the temperature of the calibration solution is inside the specified range before starting a calibration
Calibration solution already used	The calibration solution has already been used for a calibration	Use another calibration solution
Slope out of range	The pH sensor calibration slope is outside the accepted limits	Make sure that there are no bubbles around the sensor element or junction
		Clean the sensor using the recommended procedures in the sensor documentation
Offset out of range	The pH sensor calibration offset is outside the accepted limits	Make sure that there are no bubbles around the sensor element or junction
		Clean the sensor using the recommended procedures in the sensor documentation
Buffer value under electrode detection limit	The value of the calibration solution is less than the low limit for sensor detection	Use a calibration solution that is inside the sensor measurement range
Cell constant out of range	The calibration value of the cell constant is outside the accepted limits	Make sure that the cell constant minimum and maximum values are correct for the application and adjust them if incorrect (refer to Change application parameters on page 63)
The connected electrode cannot be calibrated or there is no application that contain calibration parameters	There is no installed application that contains calibration parameters, or the sensor is not a sensor that can be calibrated (e.g. PtPt or ORP sensors)	Make sure that at least one application that contains calibration parameters for the sensor has been installed, and that the sensor is a sensor that can be calibrated (e.g. pH or conductivity sensors)

Table 10 Calibration (continued)

Error/Warning	Description	Possible solution
No titrant to calibrate	There is no method to calibrate the titrant into the application. If more than one application is installed, there is no method to calibrate the titrant into all the applications.	The titrant cannot be calibrated with the current application. Refer to the related application note to find if the titrant calibration is available.
	The titrant calibration has been deactivated (Basic or Expert mode: Active = No)	Activate the titrant calibration (Active = Yes)

Table 11 USB storage device

Error/Warning	Description	Possible solution
Exporting {application name} - access forbidden to the applications folder on USB flash drive	Error when exporting data to the USB storage device	Make sure that the USB storage device is correctly installed and the USB icon can be seen in the header bar (refer to Table 4 on page 26)
		Remove the USB storage device and make sure the USB icon is no longer seen in the header bar, then install the device again and make sure that the icon can be seen (refer to Table 4 on page 26)
Exporting {application name} - read only access to the applications folder on USB flash drive	The USB storage device is read only	Unlock the storage device or use another one
Exporting {application name} - error during writing. Verify USB flash drive is not full	Error when exporting data to the USB storage device	Make sure that the USB storage device has enough available space or use another one
USB flash drive is not installed. Install and export applications again	The instrument cannot find a USB storage device	Make sure that the USB storage device is correctly installed and the USB icon can be seen in the header bar (refer to Table 4 on page 26)
		Remove the USB storage device and make sure the USB icon is no longer seen in the header bar, then install the device again and make sure that the icon can be seen (refer to Table 4 on page 26)
Application {application name}: maximum number of applications is reached	The maximum number of applications for each line has been reached when copying applications to the instrument from the USB storage device	Remove any unwanted applications, then push the Home key to return to the home screen. Remove the USB storage device and make sure the USB icon is no longer seen in the header bar, then install the device again and import the new application again

Table 11 USB storage device (continued)

Error/Warning	Description	Possible solution
Application {application name}: requires at least one titrant that cannot be installed	The titrant needed by the application cannot be installed on the instrument because the applications currently installed use another titrant	<p>Single syringe instrument: Remove all installed applications, then push the Home key to return to the home screen. Remove the USB storage device and make sure the USB icon is no longer seen in the header bar, then install the device again and import the new application again</p> <p>Two syringe instrument where the application uses only one titrant: Remove all installed applications from the line of applications using that titrant and then push the Home key to return to the home screen. Remove the USB storage device and make sure the USB icon is no longer seen in the header bar, then install the device again and import the new application again</p> <p>Two syringe instrument where the application uses two titrants:</p> <ul style="list-style-type: none"> • If the two titrants are not already used by the installed applications, remove all installed applications, then push the Home key to return to the home screen. Remove the USB storage device and make sure the USB icon is no longer seen in the header bar, then install the device again and import the new application again • If one of the two titrants is already installed, remove all installed applications from the line of applications using the other titrant and then push the Home key to return to the home screen. Remove the USB storage device and make sure the USB icon is no longer seen in the header bar, then install the device again and import the new application again
Application {application name}: requires too many titrants for this instrument model configuration	The instrument has a single syringe and the application needs a two syringe instrument	Change to a two syringe instrument
Error while saving application {application name}	Error when copying from the USB storage device to the instrument memory	Contact technical support
Unable to read applications from device. Applications have been removed, please load them from USB flash drive	While updating the application tiles on the display, an installed application has been detected as corrupt	Remove the corrupt application and try to load it again
Application {application name} corrupted	The selected application file is invalid	Try to load the original application file again, or contact technical support for a replacement file
Application {application name} incompatible with hardware	The hardware does not support the application	Change to a compatible instrument
Application {application name} (too new model)	This selection is not allowed because the instrument software only supports older application files	Update the instrument software

Table 11 USB storage device (continued)

Error/Warning	Description	Possible solution
Application {application name} (untrusted)	This selection is not allowed because the application has not been authenticated	Contact technical support to get an authenticated application file
Application {application name} (obsolete)	The selection is allowed. When the application is exported, it will automatically update to the latest version	The automatic update will set the new application parameters to the default values. It is not recommended to use an obsolete application, but to install the latest version
Application {application name} (syringe to replace)	The selection is allowed but the syringe recommended in the application file is not the one installed on the instrument	Change the installed syringe to the one recommended by the application (refer to Syringe management on page 43)
Error while serializing data	Error when creating a file on the USB storage device	Change or format the USB storage device and try the export again
Cannot write to USB mass storage	USB storage device is not installed	Remove the USB storage device and make sure the USB icon is no longer seen in the header bar, then install the device again try the export again
	USB storage device is corrupt	Change or format the USB storage device and try the export again

Table 12 Data updates

Error/Warning	Description	Possible solution
Edit user failed. Be sure that name {user name} is not already used	The update to the operator name cannot be done	Check that the name is not already used
Fail to save the modification of the application	The update to the application data cannot be done	Try again, if the problem continues, contact technical support
Impossible to remove application {application name}	The application cannot be erased	Try again, if the problem continues, contact technical support
Error while deleting data	The data cannot be erased	Try again, if the problem continues, contact technical support

Table 13 Battery

Error/Warning	Description	Possible solution
Battery voltage low	Battery voltage is below 2.2 V. The date and time are no longer available	Contact technical support
Realtime clock has been lost	The date and time are no longer available	Set the date and time again. If the date and time are not available the next time the instrument is set to on, contact technical support

Table 14 Balance

Error/Warning	Description	Possible solution
Format of message received from the balance is not supported	The data received from the balance is not compatible with the format of messages accepted by the instrument	Configure the balance to be compatible with the format of messages accepted by the instrument (refer to Install a balance on page 21)
No connection with balance	The instrument is not receiving data from the balance	Check the balance cable is installed correctly
The measurement received is out of range	The weight sent by the balance is not in the acceptance limits	Adjust the sample. Adjust the acceptance limit for the application

Table 15 Syringe verification

Error/Warning	Description	Possible solution
Format of message received from the balance is not supported	The data received from the balance is not compatible with the format of messages accepted by the instrument (fully automated mode only).	<p>Configure the balance to be compatible with the format of messages accepted by the instrument (refer to Install a balance on page 21)</p> <p>Make sure that the weight measurement is stable and did not get to the maximum weight.</p>
No connection with balance	The instrument is not receiving data from the balance (fully automated mode only).	Make sure that the balance cable is installed correctly.
Temperature sensor not detected	The instrument is not receiving data from the temperature sensor (fully and partially automated modes only)	Make sure that the temperature sensor is installed and connected correctly.
Incorrect input value	The input value is out of range (fully and partially automated modes only).	Make sure that the syringe verification configuration values are correct.
No operator recorded	The operator value is not defined on the syringe verification screen.	Set an operator on the syringe verification configuration.
Serialization error	There was an error during the results export.	Remove the USB storage device and make sure the USB icon is no longer seen in the header bar, then install the device again try the export again. Try again, if the problem continues, contact technical support.
USB mass storage writing error	Error when exporting data to the USB storage device	Make sure that the USB storage device is correctly installed and the USB icon can be seen in the header bar (refer to Table 4 on page 26).

Section 10 Replacement parts and accessories



⚠ WARNING



Personal injury hazard. Use of non-approved parts may cause personal injury, damage to the instrument or equipment malfunction. The replacement parts in this section are approved by the manufacturer.

Note: Product and Article numbers may vary for some selling regions. Contact the appropriate distributor or refer to the company website for contact information.

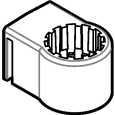
Table 16 Replacement parts and accessories

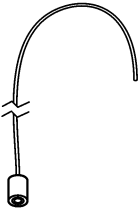
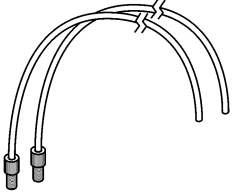
	Description	Item no.
	Syringe 2.5 mL, glass Syringe 5 mL, glass Syringe 10 mL, glass Syringe 25 mL, glass	LZE100 LZE101 LZE102 LZE103
	O-ring for 2.5 mL syringe O-ring for 5 mL syringe O-ring for 10 mL syringe O-ring for 25 mL syringe	LZE104 LZE105 LZE106 LZE107
	Set of beakers 50 mL (5x) Set of beakers 150 mL (5x)	LZE108 LZE109
	Delivery tubing with anti-diffusion tip	LZE112
	Set of tubes (2x) for syringe, suction & delivery Set of tubes (2x) for pump, suction & delivery	LZE114 LZE115

Replacement parts and accessories

Table 16 Replacement parts and accessories (continued)







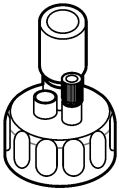
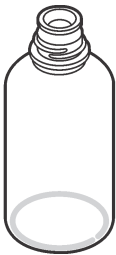

	Description	Item no.
	Bottle stopper GL25 Bottle stopper GL45 Bottle stopper S40 Bottle stopper GL32	LZE116 LZE117 LZE118 LZE186
	Glass bottle, 1L	LZE119
	Desiccant tube empty with cotton Desiccant tube filled with molecular sieve	LZE120 LZE121
	Conical adapter NS14.5/23 Conical adapter, large cut (for 7.5 mm diameter)	LZE122 LZE182
	Tube fitting (2x)	LZE124
	Spare pump cassette	LZE125

Table 16 Replacement parts and accessories (continued)

	Description	Item no.
	Magnetic stir bar, PTFE, 20 x 6 mm (5x)	LZE136
	Tube holder, 4 positions	LZE141
	Sample leveling pump	LZE142
	Propeller stirrer, 70 mm shaft	LZE143
	Power supply (without power cable)	LZE144
	Power cable (EU)	YAA080

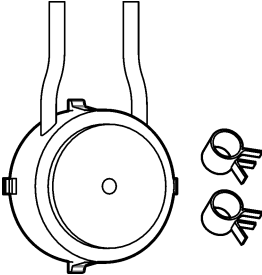
Replacement parts and accessories

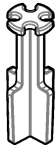
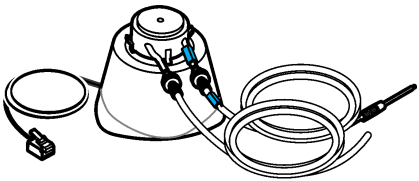
Table 16 Replacement parts and accessories (continued)

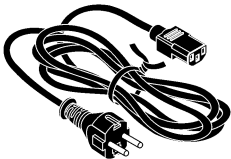

	Description	Item no.
	Power cable (US)	XLH055
	Power cable (UK)	XLH057
	RS-232 adapter cable	LZE145
	Syringe protection cover	LZE156
	Electro-valve block and connector	LZE165
	Sensor storage tubes	LZE185

Table 16 Replacement parts and accessories (continued)

	Description	Item no.
	RS-232 cable for balance connection to TitraLab	LZE196
	Thermo-Drucker USB printer	LQV161.99.10000
	AT1000/KF1000 syringe volume verification kit	LZE228

Table 17 Electrodes and electrode accessories

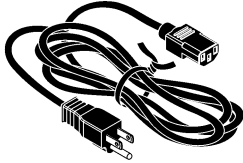
Description	Item no.
MTC301, platinum combined electrode, 1 m cable	MTC30101
MTC306, silver combined electrode, 1 m cable	MTC30601
MTC695, Pt-Pt electrode, 1 m cable	MTC69501
PHC705, pH probe, red rod, glass, general purpose, standard	PHC70501
PHC725, pH probe, glass	PHC72501
PHC805, pH probe, glass, general purpose	PHC80501
CDC401 conductivity probe, standard, 1 m cable	CDC40101
ISECa calcium combined selective	LZW9660C.97.002
Legacy adapter	LZV662
OPT300 photolorimetric probe	E71T001
PTM450, NP photolorimetric titration module, without power	X61T005
pHG311-9 pH electrode, pH 0-14, FX	E11M004
pHG301-9 pH electrode, glass	E11M001
REF251 reference electrode, red rod, double junction, banana	E21M001
CL114 cable FX/COAX/1m/BNC	A94L114
REF361 reference electrode, Ag/AgCl, reverse sleeve, FX	E21M003
Adaptor BNC male to banana	LZE184
REF451 reference electrode, calomel, double junction, FX	E21M005
ISE25Cu-9 ion selective, copper, FX	E41M006
CL111 cable FX/COAX/1m/banana	A94L111

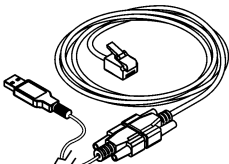
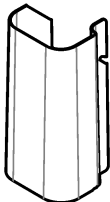
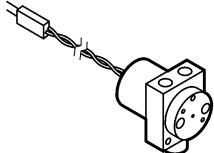
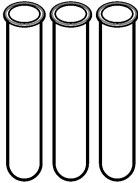
Appendix A Change application parameters

NOTICE

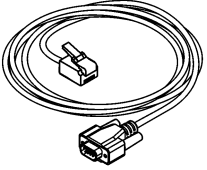
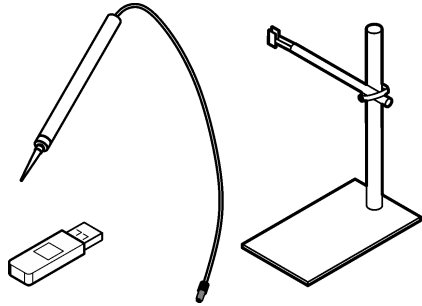
The applications installed on the instrument have been pre-defined to optimize the measurement process. Changing these default application parameters will have an effect on the measurement process and measurement results. Only qualified personnel should change these parameters or use the instrument in **Expert mode**. Refer to the application note before changing any parameters.

NOTICE

In **Basic mode** changes to parameters are secure. In **Expert mode** changes to parameters are not secure and can cause the application to run incorrectly.

NOTICE

The **Active** parameter is available to change in some parameter groups. It specifies if the method should be used during the analysis. Changing this from **Yes** to **No** means that the method will not be used which will have an effect on the measurement process and measurement results.

NOTICE

The **Hide result** parameter (e.g. R2 hide, R3 hide, etc.) is available to change in some parameter groups. It specifies if the result is shown on the display. Changing this from **Yes** to **No** means that the calculated measurement result will not be shown. This will not have an effect on the measurement process and measurement results.

The parameters available for change can be different for each instrument configuration and the application being edited. The parameters marked with an "x" are available for change.

Table 18 Application

Parameter	Description	Basic mode	Expert mode
Name	Name of the application	x	x
Advisable syringe	The application has been designed with this type of syringe		

Table 19 Sample

Parameter	Description	Basic mode	Expert mode
Name	Name of the sample	x	x
Amount	Amount of the sample	x	x
Unit	Unit of the sample		x
Min. amount	Minimum permitted sample amount		x
Max. amount	Maximum permitted sample amount		x
Resolution	Number of decimals to show for the sample amount		x

Table 20 QC

Parameter	Description	Basic mode	Expert mode
Name	Name of the QC	x	x

Table 21 Blank

Parameter	Description	Basic mode	Expert mode
Description	Description of the blank	x	x

Change application parameters

Table 22 Electrode

Parameter	Description	Basic mode	Expert mode
Type	Type of measurement electrode		
Part of name	Part of the name used to identify matching electrodes if the preferred electrode is not connected		
Recommended electrode	Recommended electrode to be used for this analysis		x
Calibration frequency	Recommended frequency of calibration (0 = no reminder)	x	x
Stability criterion	Refer to the working procedure for the recommended value		x
Max. stability time	Maximum time limit for the stability check		x
Stirring speed	Speed of the stirrer during electrode calibration	x	x
pH electrode parameters			
Stirring duration	Stirring duration before buffer measurement (0 = buffer measurement with stirring)		x
Max. temp. variation	Maximum permitted temperature variation during calibration		
Min. slope	Minimum permitted slope limit for the calibration result		x
Max. slope	Maximum permitted slope limit for the calibration result		x
Min. offset	Minimum permitted offset limit for the calibration result		x
Max. offset	Maximum permitted offset limit for the calibration result		x
Calibration mode	Set the electrode calibration mode		x
Buffer set	List of available buffers for electrode calibration	x	x
Number fixed buffers	The number of fixed buffers to use		
Fixed buffer #n	Buffer to be used during calibration		x
Conductivity electrode parameters			
Calibration mode	Set the electrode calibration mode		x
Standard	Standard used for electrode calibration	x	x
Min. cell constant	Minimum permitted cell constant for the calibration result		x
Max. cell constant	Maximum permitted cell constant for the calibration result		x
Temp. compensation	Follow Natural Water Standards ISO/DIS_7888		x
Linear temp. coeff.	Coefficient for linear temperature compensation mode		x
Reference temp.	Reference temperature for linear temperature compensation mode		x
PtPt electrode parameters			
Working mode	Specify if the probe is used in imposed voltage/current (AC or DC)		x
Current (sample analysis)	Set the value of the imposed current during sample analysis		x
Current (titrant calibration)	Set the value of the imposed current during titrant calibration		x
Voltage (sample analysis)	Set the value of the imposed voltage during sample analysis		x
Voltage (titrant calibration)	Set the value of the imposed voltage during titrant calibration		x

Table 23 Titrant

Parameter	Description	Basic mode	Expert mode
Name	Name of the titrant		x
Titrant concentration	Nominal concentration of the titrant		x
Resolution	Number of decimals of the nominal concentration of the titrant		x
Unit	Unit of the titrant		x
Real concentration	Real concentration of the titrant used for result calculation	x	x
Resolution	Number of decimals of the real concentration of the titrant		x
Location	The syringe that contains the titrant		
Titrant calibration			
Active	Select No to skip this method during titrant calibration	x	x
Calibration frequency	Recommended frequency of titrant calibration (0 = no reminder)	x	x
Stirring speed	Speed of the stirrer during titrant calibration	x	x
Incremental addition			
Predose type	Type of the predose (in volume or in ordinate)		x
Predose volume	Titrant volume added at the beginning of the titration		x
Predose ordinate	Ordinate measurement to reach to stop the predose		x
Predose speed	Speed in mL/min during the predose in ordinate		x
Delay	Stirring time before the titration starts		x
Max. vol. stop point	Stops the titration when this volume is reached		x
Ordinate stop point	Stops the titration when this ordinate is reached		x
Stop on last EQP	Stops the titration on the last equivalent point detection		x
Min. ordinate	Contact technical support before changing. The minimum ordinate value is used in the regulation algorithm during the dynamic addition		x
Max. ordinate	Contact technical support before changing. The maximum ordinate value is used in the regulation algorithm during the dynamic addition		x
Min. angle	Contact technical support before changing. The minimum tangent angle value is used in the regulation algorithm during the dynamic addition		x
Max. angle	Contact technical support before changing. The maximum tangent angle value is used in the regulation algorithm during the dynamic addition		x
Min. stability time	Minimum time after an increment addition		x
Max. stability time	Maximum time after an increment addition		x
Stability criterion	Stability criterion after an increment addition		x
Increment size	Increment size when the addition is monotonic		x
Min. increment size	Minimum increment volume when the addition is dynamic		x
Max. increment size	Maximum increment volume when the addition is dynamic		x
EP detection			
EP1 ordinate	Ordinate of this end point		x

Change application parameters

Table 23 Titrant (continued)

Parameter	Description	Basic mode	Expert mode
IP detection			
Derivative filter	Contact technical support before changing. Number of points used for building the derivative		x
Detection threshold	Contact technical support before changing. The minimum value of the derivative for inflexion point detection		x
IP1 min. ordinate	Minimum permitted value for this inflexion point		x
IP1 max. ordinate	Maximum permitted value for this inflexion point		x
Angle detection			
Maximum abscissa	Contact technical support before changing. The maximum abscissa is used in the algorithm for equivalence calculation		x
Curve filter	Contact technical support before changing. Number of points used for building the titration curve		x
Curvature filter	Contact technical support before changing. Number of points used for the curvature calculation		x
Detection threshold	Contact technical support before changing. The minimum value of the curvature for equivalence detection		x
Linearity threshold	Contact technical support before changing. The minimum value of the curvature used in the algorithm for equivalence calculation		x
EQP min. ordinate	Minimum permitted value for this equivalence point		x
EQP max. ordinate	Maximum permitted value for this equivalence point		x
Stop on flat signal	Stops titration when a flat signal is detected		x
Derivative filter	Contact technical support before changing. Number of points used for building the derivative used in flat signal detection		x
Min. derivative	Contact technical support before changing. Minimum threshold on derivative for flat signal detection		x
Max. derivative	Contact technical support before changing. Maximum threshold on derivative for flat signal detection		x
Derivative number	Contact technical support before changing. Number of derivative values between the minimum and maximum thresholds to stop the titration on a flat signal		x
Titration calculation			
Resolution	Maximum number of decimals to show for the real concentration of the titrant		x
Titrant cal. limit check	Activate the titrant calibration result boundary check		x
Min. titrant conc.	Minimum value of the real concentration of the titrant		x
Max. titrant conc.	Maximum value of the real concentration of the titrant		x
Titrant cal. EQP index	Index of the equivalence point used for the titrant calibration calculation		x
Standard name	Name of the standard		x
Standard amount	Amount of standard to be used for titer determination		x
Unit	Unit of the standard amount		x
Min. amount	Minimum amount of the standard		x

Table 23 Titrant (continued)

Parameter	Description	Basic mode	Expert mode
Max. amount	Maximum amount of the standard		x
Concentration	Concentration value of the standard	x	x
Unit	Unit of the concentration value of the standard		x
Resolution	Number of decimals of the concentration value of the standard		x
Standard equivalents	Number of exchanged equivalents of the standard (H+; e-; ...)		x
Titrant equivalents	Number of exchanged equivalents of the titrant (H+; e-; ...)		x
Molar weight	Molar weight of the standard		x

Table 24 Methods

Parameter	Description	Basic mode	Expert mode
Agitation method			
Active	Select No to skip this method during analysis	x	x
Time	Duration of the stirring	x	x
Stirring speed	Speed of the stirrer during this method	x	x
Message	Information shown during the analysis		
Auxiliary addition method			
Active	Select No to skip this method during analysis	x	x
Reagent	Name of the reagent to add	x	x
Pump ID	Pump identifier		x
Time	Duration of the pump activation	x	x
Stirring speed	Speed of the stirrer during the addition	x	x
Leveling method			
Active	Select No to skip this method during analysis	x	x
Time	Duration of the pump activation	x	x
Autoleveling calibration			
Solution name	Name of the solution used for autoleveling calibration	x	x
Solution concentration	Concentration value of the standard	x	x
Unit	Unit of the concentration value of the standard		x
Resolution	Number of decimals for the concentration value of the standard		x
Message method			
Active	Select No to skip this method during analysis	x	x
Message	Information shown during the analysis		
Stirring speed	Speed of the stirrer during this method	x	x
Input value method			
Active	Select No to skip this method during analysis	x	x
Message	Information shown during the analysis		
Stirring speed	Speed of the stirrer during this method	x	x

Change application parameters

Table 24 Methods (continued)

Parameter	Description	Basic mode	Expert mode
Resolution	Maximum number of decimals for the input value		
Hide	The result is not shown if Yes is selected	x	x
Min. value	Minimum permitted input value		x
Max. value	Maximum permitted input value		x
Measurement method			
Active	Select No to skip this method during analysis	x	x
Max. stability time	Time limit for the stability check		x
Stability criterion	Refer to the working procedure for the recommended value		x
Stirring speed	Speed of the stirrer during the measurement	x	x
Result 1 (R1) name	Name of the result	x	x
R1 max. resolution	Maximum number of decimals to show for the result		x
R1 hide	The result is not shown if Yes is selected	x	x
R1 limit check	Activate the sample result boundary check		x
R1 min.	Minimum permitted result value		x
R1 max.	Maximum permitted result value		x
R1 QC min.	Minimum permitted QC result value		x
R1 QC max.	Maximum permitted QC result value		x
Sample batch preparation method			
Stirring duration	Duration of the stirring during the addition	x	x
Pump ID	Pump identifier	x	x
Addition duration	Duration of the addition of reagent by the pump	x	x
Preparation duration	Duration of the sample batch preparation	x	x
Excess titrant addition method			
Addition	Excess addition done immediately at application start or just before titration	x	x
Analysis titration method			
Active	Select No to skip this method during analysis	x	x
Stirring speed	Speed of the stirrer during titration	x	x
Measured parameter	Parameter measured by the probe		
Predose type	Type of the predose (in volume or in ordinate)		x
Predose volume	Titration volume added at the beginning of the titration	x	x
Predose ordinate	Measurement ordinate to reach to stop the predose	x	x
Predose speed	Speed in mL/min during the predose ordinate		x
Delay	Stirring time before the titration starts	x	x
Addition mode	Titration addition mode (monotonic or dynamic)		x
Min. ordinate	Contact technical support before changing. The minimum ordinate value is used in the regulation algorithm during the dynamic addition		x

Table 24 Methods (continued)

Parameter	Description	Basic mode	Expert mode
Max. ordinate	Contact technical support before changing. The maximum ordinate value is used in the regulation algorithm during the dynamic addition		x
Max. vol. stop point	Stops the titration when this volume is reached		x
Ordinate stop point	Stops the titration when this ordinate is reached		x
Stop on last EQP	Stops the titration on last equivalent point detection		x
Min. angle	Contact technical support before changing. The minimum tangent angle value is used in the regulation algorithm during the dynamic addition		x
Max. angle	Contact technical support before changing. The maximum tangent angle value is used in the regulation algorithm during the dynamic addition		x
Min. stability time	Minimum time after an increment addition		x
Max. stability time	Maximum time after an increment addition		x
Stability criterion	Stability criterion after an increment addition		x
Increment size	Increment size when the addition is monotonic		x
Min. increment size	Minimum increment volume when the addition is dynamic		x
Max. increment size	Maximum increment volume when the addition is dynamic		x
Back titration mode	Excess addition mode		x
Excess vol.	Volume of the excess titrant		x
Excess titrant name	Name of the excess titrant		
Excess titrant conc.	Nominal concentration of the excess titrant		x
Resolution	Number of decimals of the concentration value of the excess titrant		x
Excess titrant conc. unit	Unit of the excess titrant concentration		x
Real conc. of excess titrant	Real concentration of the excess titrant	x	x
Excess equivalents	Number of exchanged equivalents of the excess (H ⁺ ; e ⁻ ; ...)		x
Sample equivalents	Number of exchanged equivalents of the sample (H ⁺ ; e ⁻ ; ...)		x
Titrant equivalents	Number of exchanged equivalents of the titrant (H ⁺ ; e ⁻ ; ...)		x
EP detection			
EP1 ordinate	Ordinate of this end point		x
IP detection			
Derivative filter	Contact technical support before changing. Number of points used for building the derivative		x
Detection threshold	Contact technical support before changing. The minimum value of the derivative for inflexion point detection		x
IP1 min. ordinate	Minimum permitted value for this inflexion point		x
IP1 max. ordinate	Maximum permitted value for this inflexion point		x
Angle detection			
Maximum abscissa	Contact technical support before changing. The maximum abscissa is used in the algorithm for equivalence calculation		x

Change application parameters

Table 24 Methods (continued)

Parameter	Description	Basic mode	Expert mode
Curve filter	Contact technical support before changing. Number of points used for building the titration curve		x
Curvature filter	Contact technical support before changing. Number of points used for the curvature calculation		x
Detection threshold	Contact technical support before changing. The minimum value of the curvature for equivalence detection		x
Linearity threshold	Contact technical support before changing. The minimum value of the curvature used in the algorithm for equivalence calculation		x
EQP min. ordinate	Minimum permitted value for this equivalence point		x
EQP max. ordinate	Maximum permitted value for this equivalence point		x
Stop on flat signal	Stops titration when a flat signal is detected		x
Derivative filter	Contact technical support before changing. Number of points used for building the derivative used in flat signal detection		x
Min. derivative	Contact technical support before changing. Minimum threshold on derivative for flat signal detection		x
Max. derivative	Contact technical support before changing. Maximum threshold on derivative for flat signal detection		x
Derivative number	Contact technical support before changing. Number of derivative values between the minimum and maximum thresholds to stop the titration on a flat signal		x
Titration calculation			
Result x (Rx) name	Name of the result	x	x
Rx max. resolution	Maximum number of decimals to show for the result		x
Rx hide	The result is not shown if Yes is selected	x	x
Rx limit check	Activate the sample result boundary check		x
Rx min.	Minimum permitted result value		x
Rx max.	Maximum permitted result value		x
Rx QC min.	Minimum permitted QC result value		x
Rx QC max.	Maximum permitted QC result value		x
Rx unit	Unit of the result		x
Rx EQP index	Index of the equivalence point used for the result calculation		x
Rx molar weight	Molar weight of analyte used for the result calculation		x
Rx sample equivalents	Number of exchanged equivalents of the sample (H ⁺ ; e ⁻ ; ...)		x
Rx titrant equivalents	Number of exchanged equivalents of the titrant (H ⁺ ; e ⁻ ; ...)		x
Titration calculation using an equation			
Result x (Rx) name	Name of the result calculated with the equation	x	x
Rx max. resolution	Maximum number of decimals to show for the result		x
Rx hide	The result is not shown if Yes is selected	x	x
Rx limit check	Activate the sample result boundary check		x
Rx min.	Minimum permitted result value		x

Table 24 Methods (continued)

Parameter	Description	Basic mode	Expert mode
Rx max.	Maximum permitted result value		x
Rx QC min.	Minimum permitted QC result value		x
Rx QC max.	Maximum permitted QC result value		x
Rx equation	Equation used for the result shown		
Rx unit	Select the result unit	x	x
Rx user value	Value that may be used in the equation computation as Fx	x	x

Appendix B Frequently asked questions

Table 25 Application files

Question	Cause	Procedure
Why can't I load any applications	Wrong file placement on the USB storage device	Make sure that the file path on the USB storage device is correct
	The user is not in the home screen	Push the Home key to make sure that you are in the home screen before connecting the USB storage device
Why is the instrument not recognizing the applications USB storage device, even though I have removed and reconnected the device and I see the USB icon in the header bar	Reconnecting the device has been done too quickly	Remove the device and wait until the icon disappears from the header bar, then push the Home key to make sure that you are in the home screen before reconnecting the device

Table 26 Titration

Question	Cause	Procedure
Why does the volume delivered not correspond to the volume displayed	The volume of the installed syringe is different from the syringe configuration	Use the recommended syringe for the application and make sure the volume is correct

Table 27 Mechanical

Question	Cause	Procedure
Why is the equivalent point not being detected at the expected volume	Air bubbles are trapped in the tubes	Select the Purge option on the instrument to purge the tubes of air bubbles (refer to Prepare the instrument for measurement on page 30)
How can I remove an air bubble that is trapped on top of the syringe	Air bubbles are trapped in the syringe	Select the Purge option on the instrument to purge the syringe of air bubbles (refer to Prepare the instrument for measurement on page 30)
Why is titrant leaking along the sealing above the electrovalve	The tubes have not been correctly installed	Turn the tube connector until a "click" is heard
Why is titrant leaking along the sealing below the electrovalve	The syringe has not been installed tight enough	Make sure that the syringe is installed correctly
	The electrovalve is leaking	Change the electrovalve as described in Replace the syringe electro-valve block on page 42
Why is the titrant not being delivered into the tubes	The titrant bottle is empty or the tube is not correctly installed in the bottle	Make sure that the titrant bottle is installed correctly
	The electrovalve is blocked or defective	Change the electrovalve as described in Replace the syringe electro-valve block on page 42
On my two syringe instrument, why is the titrant not being delivered into the beaker but back into the titrant bottle	The procedure is not being done on the correct syringe	Select the Syringe activation option on the instrument, and Toggle the syringes to make sure that the correct syringe is being used in the application
	The active syringe is not the correct syringe	Erase all the installed applications and install them again. The applications on line 1 will be allocated to syringe 1 and the applications on line 2 will be allocated to syringe 2. Make sure the titrant and installation is correct for the syringe (refer to Install the titrant and the reagent on page 16)

Frequently asked questions

Table 27 Mechanical (continued)

Question	Cause	Procedure
On my two pump instrument, using the Pump activation option, why is the reagent not being delivered into the beaker	The procedure is not being done on the correct pump	Select the Pump activation option on the instrument, and Toggle the pumps to make sure that the correct pump is being used
	The active pump is not the correct pump	Change to expert mode and change the name of the pump
	The pump is defective	Change the pump as described in Pump cassette replacement on page 44

Table 28 Password

Question	Procedure
How can I retrieve my password to access expert mode	Contact technical support

Section 13 Configure the instrument

1. From the home screen, select **Settings**. Refer also to [Menu structure](#) on page 26.
2. Select an option, then push **Select**.

Option	Description
Applications	Changes (refer to Change the application settings on page 38), makes copies, exports and removes application data. Make sure that the duplication function does not make more than five applications for each syringe installed.
Operators	Adds, changes and removes operators.
Date + Time	Sets the instrument date and time.
Brightness	Sets the brightness of the display.
Sounds	Sets the sound options.
Language	Sets the language.
Network	Give a name to the instrument. This name is used to connect the instrument to a PC. If a printer is connected, this name is printed on the hard-copy output. Restart the instrument if the name is changed.
Legacy settings	Specify the sensor data when the legacy adapter is used.
Info	Shows information about the instrument and the attached hardware.
Restore Defaults	Sets the instrument to the default configuration. The restored settings are: <ul style="list-style-type: none">• The language is set to English• All password security is removed• The security password is set to 0000• No sound on: Key press, Information and Analysis results OK• Sound on: Instrument ready, Instrument switch off, Errors and Analysis results not OK• The application parameters view is set to basic mode• Sets the syringe to empty when the instrument is set to off• The temperature display unit is set to °C• No print of the measurement curve• No print of the derivative curves• No balance is connected• No propeller stirrer is connected• The default stirring is set to 10%• The user is set to "Default user"

Configure the instrument

Option	Description
Options	<p>Sets the following options:</p> <ul style="list-style-type: none">• Set the application parameters view to expert or basic mode• When the instrument is set to off, sets the syringe to empty into the titrant bottle• Changes the temperature display unit• Prints the measurement and derivative curves if a printer is connected• Specify if a balance is connected• Specify if an external propeller stirrer is connected. <p>Note: When the instrument is set to on, the application parameters view is always set to basic mode. Changes made to application data with the instrument in expert mode are kept.</p>
Security	<p>Change the password. Specify which of these options are password protected:</p> <ul style="list-style-type: none">• Settings (all items except Info)• Maintenance schedule and summary• Delete data log• Export data log• Electrode calibration• Titrant calibration• Sample volume calibration• Syringe verification test

3. Push **Back**.

HACH COMPANY World Headquarters

P.O. Box 389, Loveland, CO 80539-0389 U.S.A.
Tel. (970) 669-3050
(800) 227-4224 (U.S.A. only)
Fax (970) 669-2932
orders@hach.com
www.hach.com

HACH LANGE GMBH

Willstätterstraße 11
D-40549 Düsseldorf, Germany
Tel. +49 (0) 2 11 52 88-320
Fax +49 (0) 2 11 52 88-210
info-de@hach.com
www.de.hach.com

HACH LANGE Sàrl

6, route de Compois
1222 Vérenaz
SWITZERLAND
Tel. +41 22 594 6400
Fax +41 22 594 6499

