



G1562HTR Portable Eyewash/Drench Hose Unit, 15 Gallon, Heated

Application: ANSI Z358.1-2014 “Emergency Eyewash and Shower Equipment” requires that the water delivered by an emergency eyewash be “tepid”, which is defined as between 60° and 100° F (15.5°- 37.8° C). The G1562HTR portable eyewash/drench hose unit is electrically heated and insulated, making it ideal for use in areas where ambient temperatures may drop below the tepid range. In extreme conditions, the heating system will also protect the unit against freezing.

The G1562HTR heated portable eyewash/drench hose unit uses air pressure to deliver 10 gallons (37.5L) of water for 15 minutes. For use in low hazard areas where a continuous supply of water is not available.

Installation: Unit can be placed in any area where hazards are present. Available with optional dolly or hand truck for ease of movement (see below). To prepare unit for use, fill with 10 gallons (37.5L) of clean potable water and add bacteriostatic additive (supplied with unit). Bacteriostatic additive protects against growth of bacteria, fungus, algae and acanthamoeba. After filling, pressurize with 80 PSI (5.5 bar) air pressure.

Heating System: Silicone drum heater is attached to outside of tank. Thermostat set to 65° F (18.3° C) senses the temperature of the water inside the tank to turn the heater on and off. Heater requires 15 amp, 120 volt power supply. Total amp draw is 3.33 amps. Furnished with 9 ft. cord with ground fault circuit interrupter (GFCI) plug and manual reset.

Exterior Jacket: High visibility orange insulated nylon jacket contains heat to maintain water temperature and protects unit against freezing. Jacket is waterproof and resistant to mildew.

Tank: 15 gallon (56L) stainless steel tank. Tank has built-in carrying handles, air intake valve, pressure gauge and pressure relief valve.

Eyewash: Use to wash user’s eyes for 15 minutes. Furnished with (2) GS-Plus low flow spray heads with “flip top” dust covers, integral flow controls and filters. Valve is ½" IPS chrome plated brass self-draining ball valve with flag handle. User’s hands are free while eyewash is in operation. Self-draining valve allows water to drain out from spray heads after use.

Drench Hose: For rinsing any part of the user’s eyes, face or body. Furnished with single GS-Plus spray head, self-closing valve with handle and 6 foot (2m) reinforced PVC hose.

Discharge Time: Eyewash delivers .7 GPM (2.6L/min) for 15 minutes. Drench hose delivers 1.7 GPM (6.4L/min) for 6 minutes. Discharge time is less if eyewash and drench hose are used simultaneously.

Weight: 42 lbs. (19kg) empty, 123 lbs. (55.8kg) filled.

Sign: Furnished with ANSI-compliant sign.

Quality Assurance: Unit is assembled and factory tested prior to shipment.



Maintenance: Unit must be inspected regularly. Refill unit after testing or use. Water and bacteriostatic additive must be changed at least once every six months.

Available Options

- G1540BA-R** Case of (4) replacement bottles of bacteriostatic additive.
- G1562HTR-DOL** G1562HTR portable unit mounted on four-wheel dolly for ease of movement.
- AP250-100** Dolly only.
- G1562HTR-HAT** G1562HTR portable unit mounted on two-wheel hand truck for ease of movement.
- AP200-013** Hand truck only.



G1562HTR Portable Eyewash/Drench Hose Unit, 15 Gallon, Heated

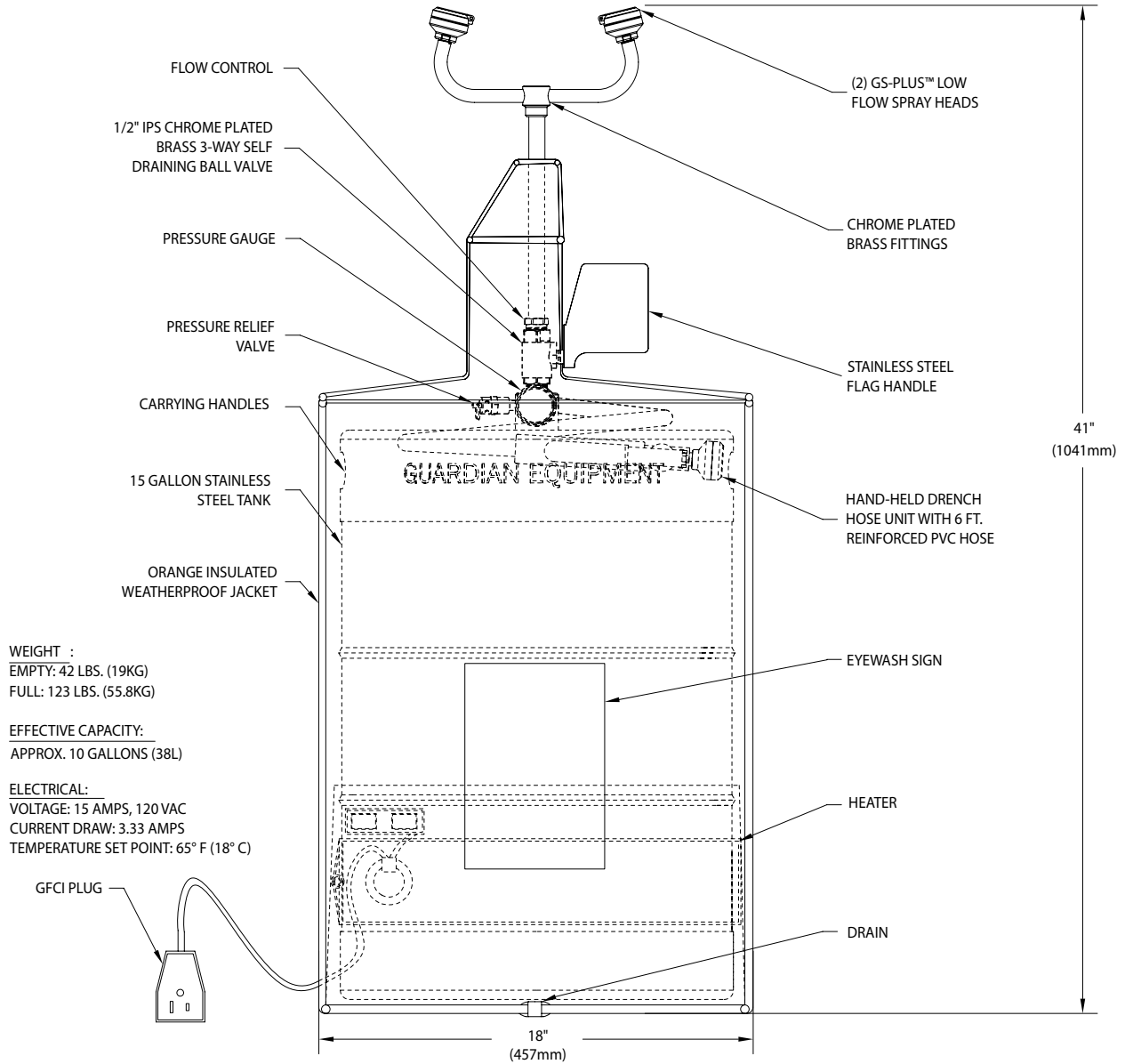

Rev. 031521

THIS SPACE FOR ARCHITECT/ENGINEER APPROVAL

Sign Included



Due to continuing product improvement, the information contained in this document is subject to change without notice. All dimensions are ± 1/4" (6mm). rev. 031521

Guardian Equipment 312 447 8100 TELEPHONE
1140 N North Branch St 312 447 8101 FACSIMILE
Chicago, IL 60642 gesafety.com

Listed 8116. Units have been tested to and comply with ANSI Z358.1-2014 and the Uniform Plumbing Code.

