

**DR 4500 Truline
Circular Chart Recorder
With or Without Control
Product Manual**

44-45-25-24C

WARRANTY:

The DR 4500 Truline Circular Chart Recorder carries a TWO-YEAR warranty. This warranty includes immediate technical assistance via a toll free telephone number and complete replacement of the recorder, if necessary.

Technical Assistance:

If you encounter a problem with your Truline recorder, review all the configuration data under the SET UP groups to verify that your selections are consistent with your application; i.e. Inputs, Outputs, Alarms, Limits, etc. If the problem persists after checking the above, you can get technical assistance by dialing:

1- 800-423-9883

An engineer will discuss your problem with you. Please have your complete model number, serial number, and configuration data available. The model and serial numbers can be found on the chart plate. If it is determined that a hardware problem exists, a replacement recorder will be shipped with instructions for returning the defective unit.

Do NOT return the recorder until the replacement has been received.

Table of Contents

About This Manual

This manual covers both model **DR 450T** and **DR 450R** Truline recorders. The data is tailored primarily for the standard model **DR 450T**, but it also applies for model **DR 450R** except as noted. The **DR 450R** functions that differ from model **DR 450T** are detailed in *Appendix D*.

The manual contains twelve sections numbered 1 through 12 plus a specification sheet which is included in the back of the manual for reference. The first four sections deal with set-up tasks for a DR 4500 recorder; sections 5, 6, and 7 cover operation, calibration, and service, respectively; section 8 is a replacement parts list; and sections 9-12 are appendices. Use this master table of contents to locate specific topics.

<i>Topic</i>	<i>Page</i>
Section 1 - Set-Up Tasks and Model Number Decoding	1-1
Major Set-Up Tasks For DR 4500 Recorder	1-1
1 Decoding the Recorder's Model Number	1-2
Figure 1-1 -- DR 4500 Recorder hardware components versus "Table" selections.	1-4
Section 2 - Mounting Your Recorder	2-1
Summary	2-1
A. Removing Knockouts for Conduits	2-1
B. Flush in Panel (New Panel Cutout)	2-2
C. Flush in Panel (Using an Existing Panel Cutout)	2-2
D. On Surface (of Panel or Wall)	2-5
Section 3 - Wiring	3-1
A. Connecting Power	3-1
B. Connecting Input 1	3-2
C. Connecting Input 2, 3 or 4	3-5
D. Connecting Control Output #1/#2	3-8
E. Connecting No. 1 & 2 Alarm	3-11
F. DMCS Communications	3-12
<i>Application Notes</i>	48-51-07-04
Section 4 - Configuring Your Recorder	4-1
Summary	4-1
Configuration Prompt Hierarchy	4-1
Figure 4-1 -- PROMPT HIERARCHY	4-2
A. Power Up	4-7
A-1. Run Key Test (Optional)	4-8
A-2. Display and Key Pad Descriptions	4-9
B. TUNING 1 and TUNING 2 Configuration	4-11
C. SP RAMP1 and SP RAMP2 Configuration	4-16

Table of Contents

<i>Topic</i>	<i>Page</i>
D. CHART Configuration	4-31
E. TIME Configuration	4-35
F. PEN 1-2-3-4 Configuration	4-41
G. INPUT 1-2-3-4 Configuration	4-46
H. TOTAL 1 and TOTAL 2 Configuration	4-53
I. CONTROL 1 and CONTROL 2 Configuration	4-57
J. OPTIONS Configuration	4-70
K. ALARMS Configuration	4-78
L. LOCKOUT Configuration	4-88
Section 5 - Operation and Maintenance	5-1
Introduction	5-1
Operating the Recorder	5-1
Preparation and Start Up	5-1
Procedure (All Models)	5-2
Monitoring Operation	5-3
Meaning of Indicators	5-3
Reading Deviation Bargraph	5-4
Viewing Displays	5-5
Displaying Totalizer Value Procedure	5-6
Monitoring External Event Operation	5-6
Meaning of Diagnostic Error Messages	5-7
Actions an Operator Can Initiate	5-8
Changing Control Mode and Adjusting Output Manually	5-8
Changing SP and Switching Between SPs	5-8
Running a Set Point Ramp	5-9
Disabling SP Ramp	5-10
Running a Set Point Ramp/Soak Program	5-10
Running a Set Point Ramp/ Soak Program using a Remote Contact	5-11
Switching Between Two Sets of PID Values	5-11
Checking Alarm Set Points	5-11
Resetting Totalizer	5-12
Closing Remote Contact (Switch)	5-13
Steps for Maximizing Pen Life	5-15
Routine Maintenance	5-16
Cleaning Pen Tip	5-16
Installing/Replacing a Chart	5-16
Replacing Burned-Out Chart Lamp (Optional)	5-16
Section 6 - Calibration	6-1
Summary	6-1
Restoring Factory Calibration	6-1
Equipment Needed	6-2

Table of Contents

<i>Topic</i>	<i>Page</i>
Common Equipment	6-2
Equipment for Thermocouple Inputs (for Ice Bath Method)	6-2
Equipment for Thermocouple Inputs (for Precision Resistor Method)	6-2
Equipment for RTD Inputs	6-2
Equipment for Milliampere, Millivolt, and Volt Inputs	6-2
Minimum and Maximum Range Values	6-2
Preliminary Procedures	6-4
Disconnecting Field Wiring	6-4
Calibration Setups for PV Inputs	6-5
Setup Procedures	6-6
General	6-6
Setup for Thermocouple Inputs (for Ice Bath Method)	6-6
Setup for Thermocouple Inputs (for Precision Resistor Method)	6-6
Setup for Resistance Thermometer Device (RTD) Inputs	6-6
Figure 6-3 -- Calibration setup diagram for thermocouple inputs using an ice bath	6-7
Figure 6-4 -- Calibration setup diagram for thermocouple inputs using a precision resistor	6-7
Figure 6-5 -- Calibration setup diagram for RTD inputs	6-8
Figure 6-6 -- Calibration setup diagram for millivolts and volts inputs (except 0 to 10 volts)	6-8
Figure 6-7 -- Calibration setup diagram for 0 to 10 volts input	6-9
Figure 6-8 -- Calibration setup diagram for 4 to 20 milliamperes inputs	6-10
Calibration Sequence	6-10
Startup Procedure	6-10
Enter Calibration Mode	6-11
Calibrating Input for 0% Range	6-11
Calibrating Input for 100% Range	6-12
Checking Cold Junction Temperature of Thermocouple Inputs	6-12
Calibrating Input 2, Input 3, and Input 4	6-13
Exit Calibration Mode	6-13
Output Calibration	6-13
Current Proportional Output	6-13
Equipment Needed	6-13
Connect Calibrator	6-13
Figure 6-9 -- Test equipment connections for calibrating current proportional output	6-14
Calibration Procedure	6-14
Position Proportional Output	6-15
Connections	6-15
Calibration Procedure	6-15
Making Adjustments in Printing Characteristics	6-16

Table of Contents

<i>Topic</i>	<i>Page</i>
Section 7 - Service	7-1
Summary	7-1
Self-Diagnostics	7-1
Customer Support	7-1
Troubleshooting	7-1
Running Status Test	7-2
Error Message Prompts	7-2
Visual Failure Symptoms	7-4
SYMPTOM 1: Recorder will not operate	7-4
SYMPTOM 2: Recorder operation is normal but pen trace is incorrect	7-4
SYMPTOM 3: Chart rotates at wrong speed or will not rotate (pen indication correct)	7-5
SYMPTOM 4: Pen remains at high end of range when input signal is low	7-5
SYMPTOM 5: Pen does not move when input signal changes ..	7-5
SYMPTOM 6: A key doesn't respond and/or a display doesn't light	7-5
SYMPTOM 7: Displayed output does not agree with controller output	7-6
(1) Current Proportional Output Type	7-6
(2) Position Proportional Output Type	7-6
(3) Single Relay or Dual Relay Output Type	7-7
(4) Duplex Current/Time or Time Current Proportional Output Type	7-7
SYMPTOM 8. External alarm function does not operate properly	7-8
Replacement Procedures	7-8
Removing a Pen Arm, Part No. 30755315-001	7-8
Replacing the Pen Arm	7-9
Removing/Replacing Servo Plate Assembly, Part No. 30754975-503 ..	7-9
Removing/Replacing Chart Motor Part No. 30745974-501	7-9
Removing/Replacing Display PCB, Part No. 30755016-501	7-10
Removing/Replacing Membrane Switch (Keyboard), Part No. 30754957-501	7-10
Removing/Replacing Main PCB, Part No. 30754999-502	7-10
Removing/Replacing Control Output PCB, Part No. 30754922-501 ..	7-10

Table of Contents

<i>Topic</i>	<i>Page</i>
Section 8 - Parts List	8-1
Introduction	8-1
Figure 8-1 -- Door assembly	8-1
Figure 8-2 -- Chart plate	8-2
Figure 8-3 -- Basic recorder components without options	8-3
Figure 8-4 -- Additional recorder components associated with options	8-4
Figure 8-5 -- Internal cabling data	8-5
 Section 9 - Appendix A	 9-1
Introduction	9-1
Parameter Groups and Prompts	9-1
Tuning Data	9-2
Set Point Ramp	9-4
Control Data	9-5
 Section 10 - Appendix B	 10-1
Introduction	10-1
Controller Tuning Procedures	10-1
Time, Position, or Current Proportional Control	10-2
Duplex Time Proportional Control	10-5
Two Sets of Tuning Parameters for Single Output Operation	10-5
 Section 11 - Appendix C	 11-1
Introduction	11-1
Configuration	11-1
What You Will Configure	11-1
RAMP TIME	11-1
SOAK SET POINT RANGE VALUES AND DURATION TIME	11-2
START SEGMENT NUMBER	11-2
END SEGMENT NUMBER	11-2
RECYCLE NUMBER	11-2
SOAK DEVIATION	11-2
PROGRAM STATE	11-3
PROGRAM TERMINATION STATE	11-3
RAMP UNIT	11-3
Drawing a Ramp/Soak Profile	11-3
Ramp/Soak Profile Example	11-4
PROGRAM RECORD SHEET	11-5

Table of Contents

<i>Topic</i>	<i>Page</i>
Section 12 - Appendix D	12-1
Introduction	12-1
1. Hardware Identification	12-1
2. Wiring Addition	12-3
G. Connecting No. 3, 4, 5 & 6 Alarm Outputs & Digital Inputs	12-3
3. Prompt Hierarchy Changes	12-4
4. Configuration Changes	12-6
D-1. FO RESET Configuration	12-6
D-2. OPTIONS Configuration	12-7
D-3. ALARMS Configuration	12-10
D-4. EVENT MESSAGE Configuration	12-38
5. Operation Additions	12-48
6. Worksheet Additions	12-48
 Specification Sheet	 44-45-03-08

Set-Up Tasks and Model Number Decoding

Section 1



Major Set-Up Tasks For DR 4500 Recorder

As shown in the flow diagram, there are four major tasks that you must complete to "Set-Up" the DR 4500 recorder for operation:

- 1 Decode your recorder's model number to verify its hardware components and software functions.
- 2 Mount the recorder flush in a panel, or on the surface of panel or a wall.
- 3 Connect power and input/output wiring.
- 4 Follow simple keystroke sequences and English language prompts to "configure" the functional characteristics of your recorder.

For easy reference, the following section numbers match the given set-up task number. Thus, proceed to the next page to decode your recorder's model number.

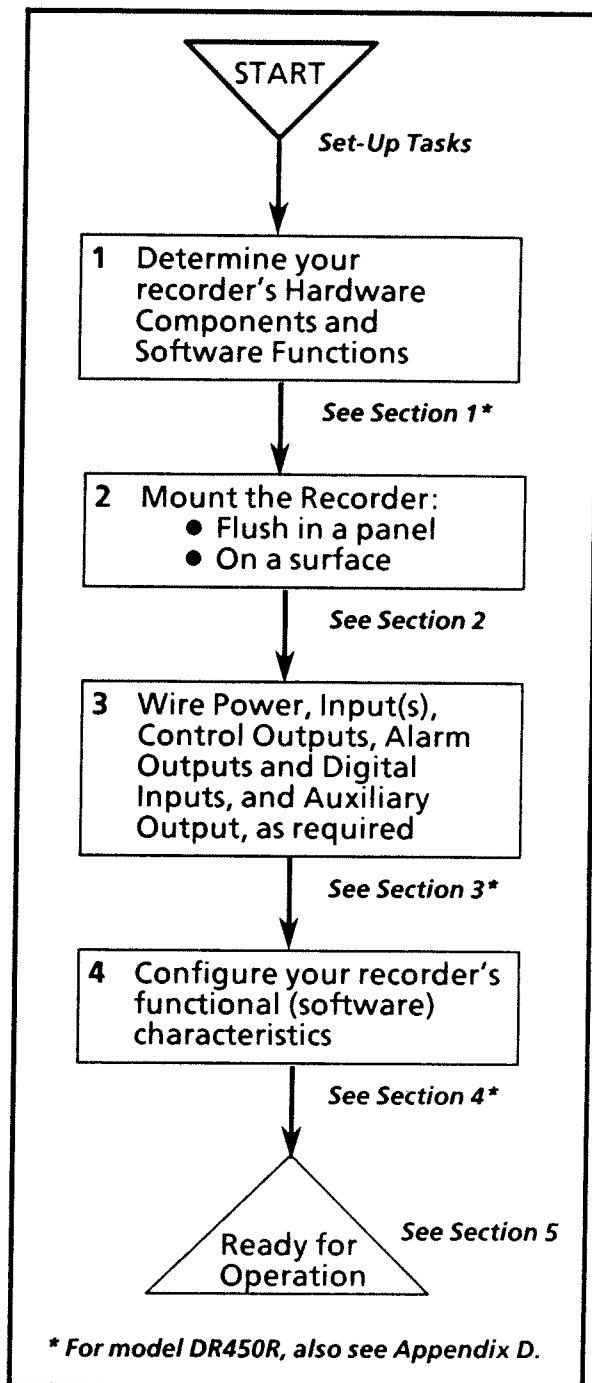

1 Decoding the Recorder's Model Number

- Copy the model number that appears on the label on the front of the recorder's chart plate into the following boxes. Then, use the table code definitions to identify the recorder's given hardware and software characteristics.

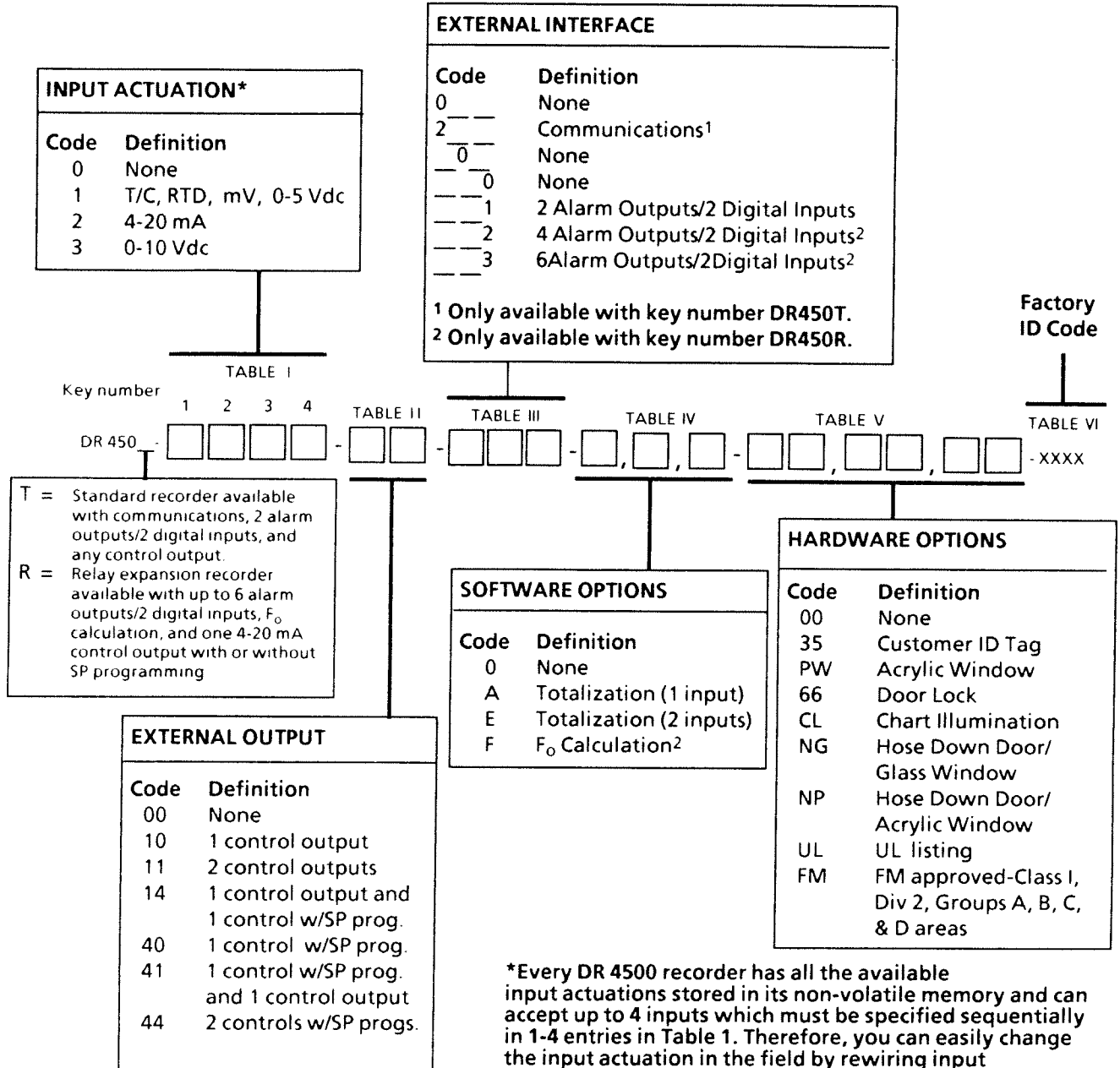



1 Decoding the Recorder's Model Number – Continued

EXAMPLE: Assume that the model number on the label is DR 450T-1200-44-001-A-PW,66,CL-XXXX. Using the table code definitions from the previous diagram, this recorder is a 2-input type with thermocouple, RTD, mV, or 0-5Vdc input for channel 1, 4-20mA input for channel 2, two controllers with set point programming capability, alarm output/digital input capability, totalization for input 1, and plastic window, door lock, and chart illumination.

2. After you decode your recorder's model number, use the following figures to match "table" selections with location of actual recorder hardware components. This will help you determine applicable input/output wiring needs as well as identify appropriate software functions to be configured later. To view actual components inside your recorder:
 - (1) Push in button on recorder door and swing door open.
 - (2) Loosen captive screw in right-hand side of chart plate and swing chart plate out.
 - (3) Reverse steps to close chart plate and door.

NEXT: Go to "Section 2 Mounting the Recorder."

1 Decoding the Recorder's Model Number – Continued

VIEW A -- Key Number: DR 450T* With One Input
 * If Key Number is DR 450R, see Appendix D for internal views.

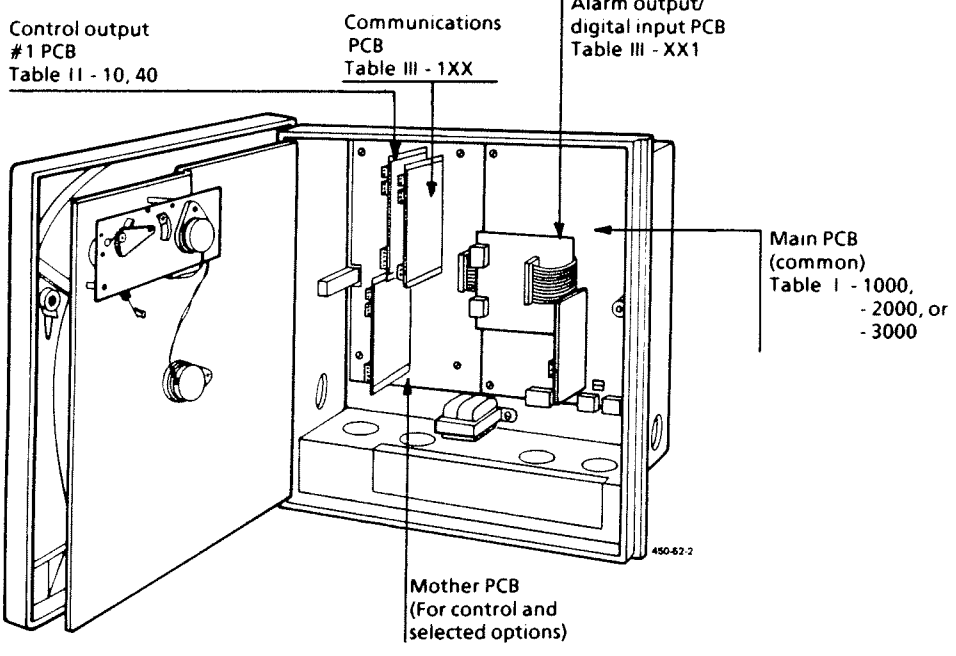
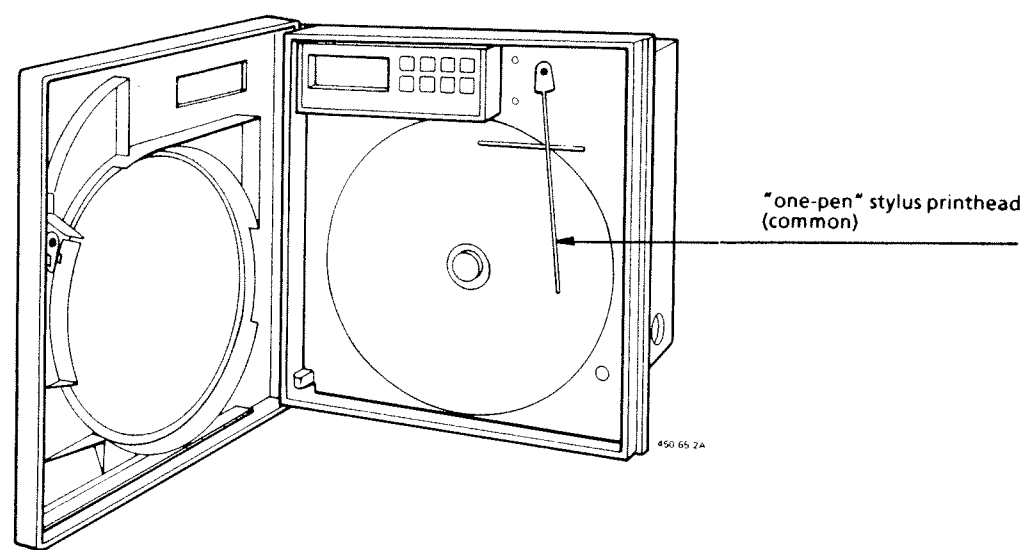

Figure 1-1 -- DR 4500 Recorder hardware components versus "Table" selections.

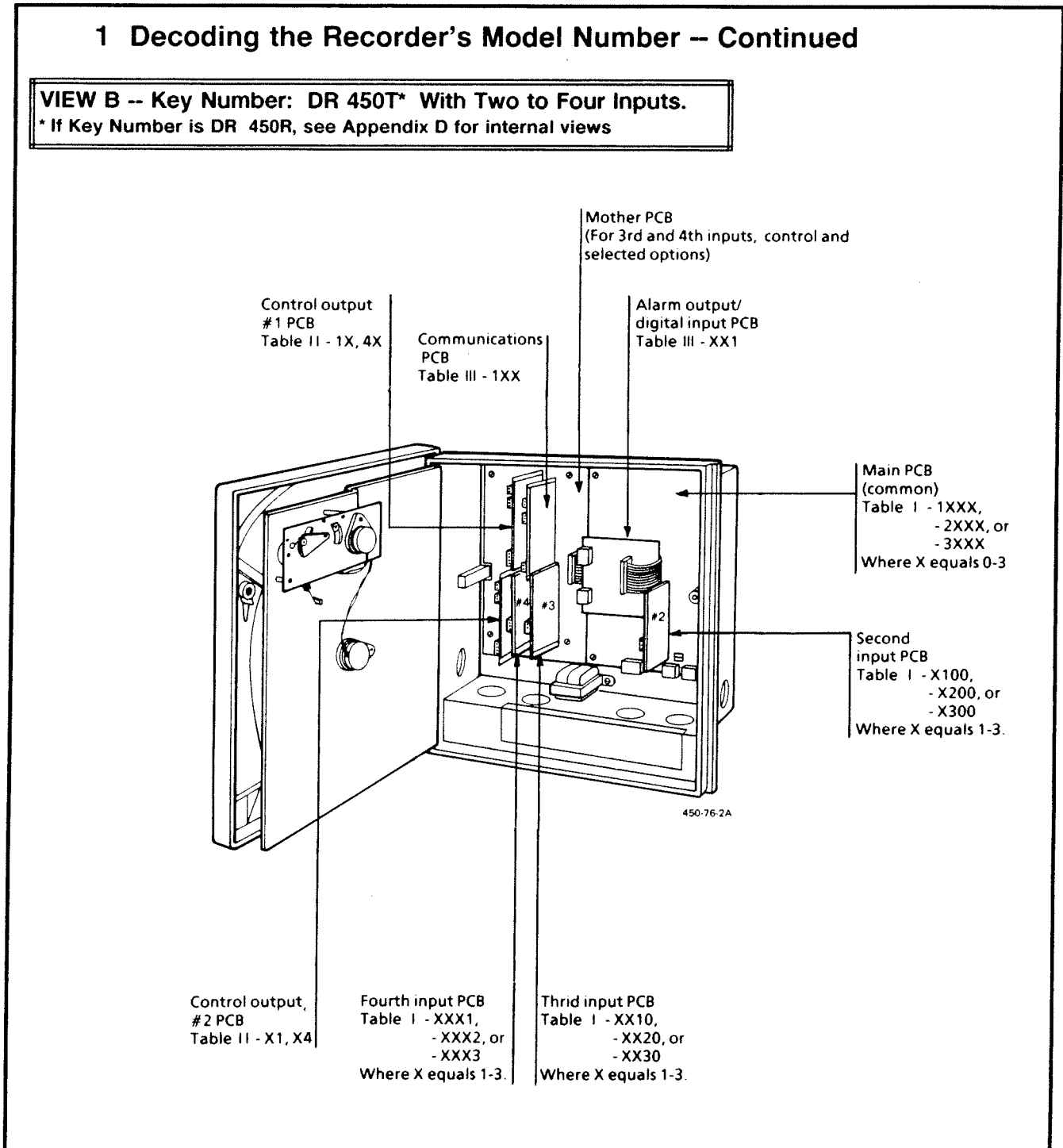

Figure 1-1 -- DR 4500 Recorder hardware components versus "Table" selections -- Continued.

Mounting Your Recorder

Section 2

Summary

You can mount the recorder in a panel by making a new cutout or using an existing cutout with a filler plate kit as noted in Table 2-1, or on the surface of a panel or wall. Procedures for each mounting method follow -- choose the one that meets your mounting requirements. Use dimension drawing 30755212-000 for reference.

Before you mount the recorder, remove the appropriate "knockouts" in the bottom and/or sides of the recorder case. See Section 3 to locate connections for the wiring.

A. Removing Knockouts for Conduits

NOTE: In some cases, the knockouts have already been removed at the factory and plugs have been inserted in their place. If your recorder has plugs instead of knockouts, just push out the appropriate plugs and skip the following Steps.

1. Place recorder on a flat worksurface as shown at right.
2. Place a flat-faced tool (such as a pin punch or a nail set) on the knockout 180 degrees from "web," and firmly strike tool with a hammer.
3. Repeat Step 2 for each knockout to be removed.

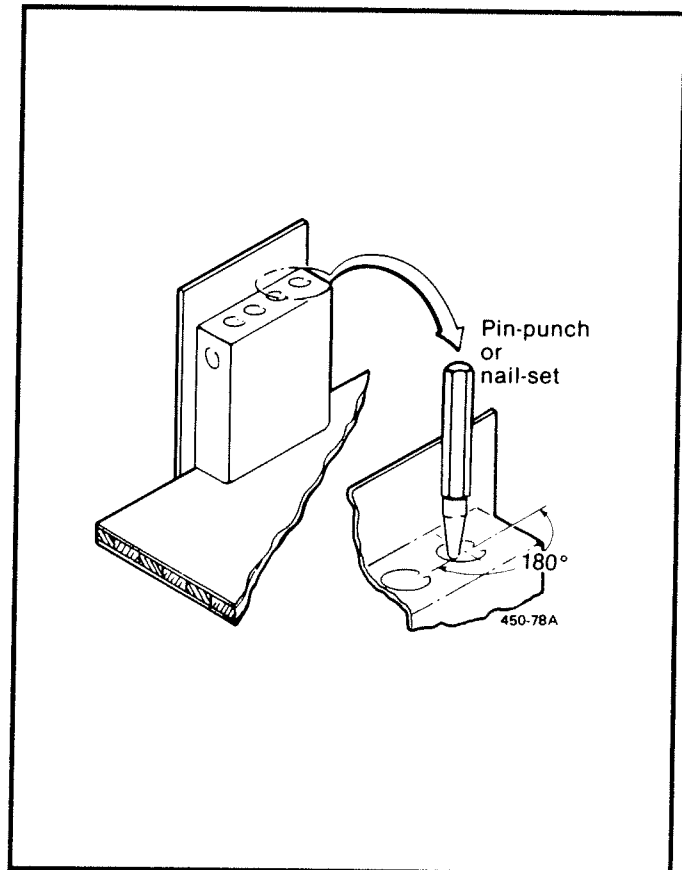

2 Mounting Your Recorder – Continued

B. Flush in Panel (New Panel Cutout)

Materials Required: Mounting Hardware supplied with recorder.

1. At appropriate location, make a square cutout in panel, 12.7 ± 0.060 inches by 12.7 ± 0.060 inches (322.58 ± 1.52 by 322.58 ± 1.52 millimeters). See dimension drawing.
2. Orient recorder case properly and slide it into cutout from front of panel. Be sure that recorder is supported in following steps.
3. From back of panel, attach a mounting bracket to each side of recorder case, using a $1/2-20 \times 1/2$ inch hex screw and a lockwasher for each bracket as shown in figure at right. Leave screws slightly loose so as to permit adjustment of brackets.
4. While holding recorder firmly against panel, slide each bracket against back of panel and tighten screws.

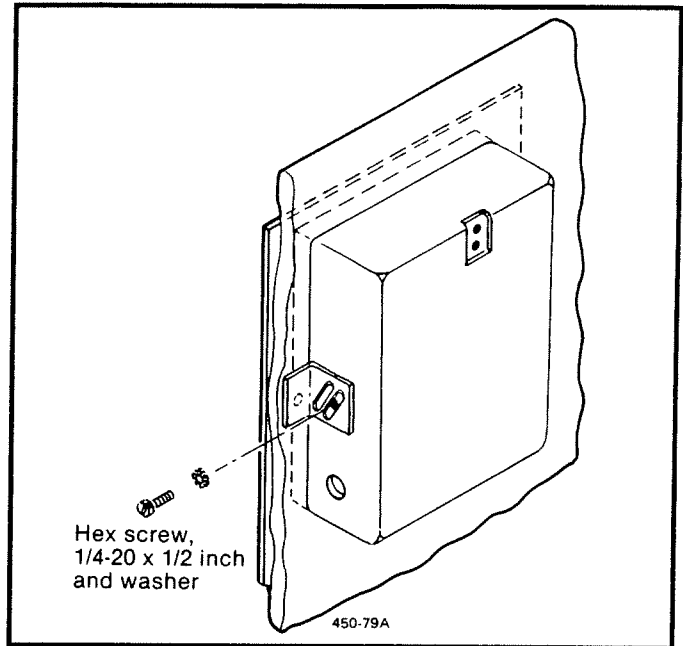

C. Flush in Panel (Using an Existing Panel Cutout)

Refer to Table 2-1 to determine whether the existing panel cutout can be used. Use procedure C-1 unless noted otherwise.

TABLE 2-1 -- Reference Data for Mounting DR 4500 in Existing Panel Cutouts

Manufacturer/Instrument	Dimensions of Existing Panel Cutout (inches)	Need Universal Filler Plate Kit 30755134-001
Honeywell/Model AR100 *	12.7 x 12.7	No*
Honeywell/Class 15	15.8 x 17.2	Yes
Honeywell/Class 45	13.12 x 17.12	Yes
Bager Meter/Model Micro Chart	14.25 x 17.88	Yes
Bristol/Models 4330, 500 Classes 1, 2A, 3B, and 5	3.56 x 18.56	Yes
Fischer and Porter/Model 51-1100	13.75 x 17.31	Yes
Foxboro/Model 40	14.38 x 17.06	Yes
Kent/Model 105M**	13.6 x 13.46	No**
Partlow/Model ER*	13.5 x 12.69	No*
Taylor/Model 76J	13.78 x 16.5	Yes

*No adaption is required, use procedure "B. Flush in Panel (New Panel Cutout)" on Page 2-2.

**Use procedure "C-2- Cutout Made for Kent Model 105M" on Page 2-4.

2 Mounting Your Recorder – Continued

Procedure C-1 -- Universal Filler Plate Kit

Materials Required:

- Mounting Hardware supplied with recorder.
- Universal Filler Plate Kit.

1. Lay recorder face down on a clean worksurface. position universal filler plate as shown in top figure at right.
2. Measure height of existing panel cutout.
3. Position support brackets, supplied with kit, so that distance from top of "window" in filler plate to right angle of support brackets is just less than height of existing panel cutout.
4. Secure brackets with two 10-32 x 1/4 inch screws provided in kit by inserting them through holes in filler plate into tapped screw holes in recorder case.
5. Insert recorder into cutout from front of panel as shown in bottom figure at right, and use Steps 3, 4 in B. Flush in Panel, (New Panel Cutout) to secure recorder in panel.

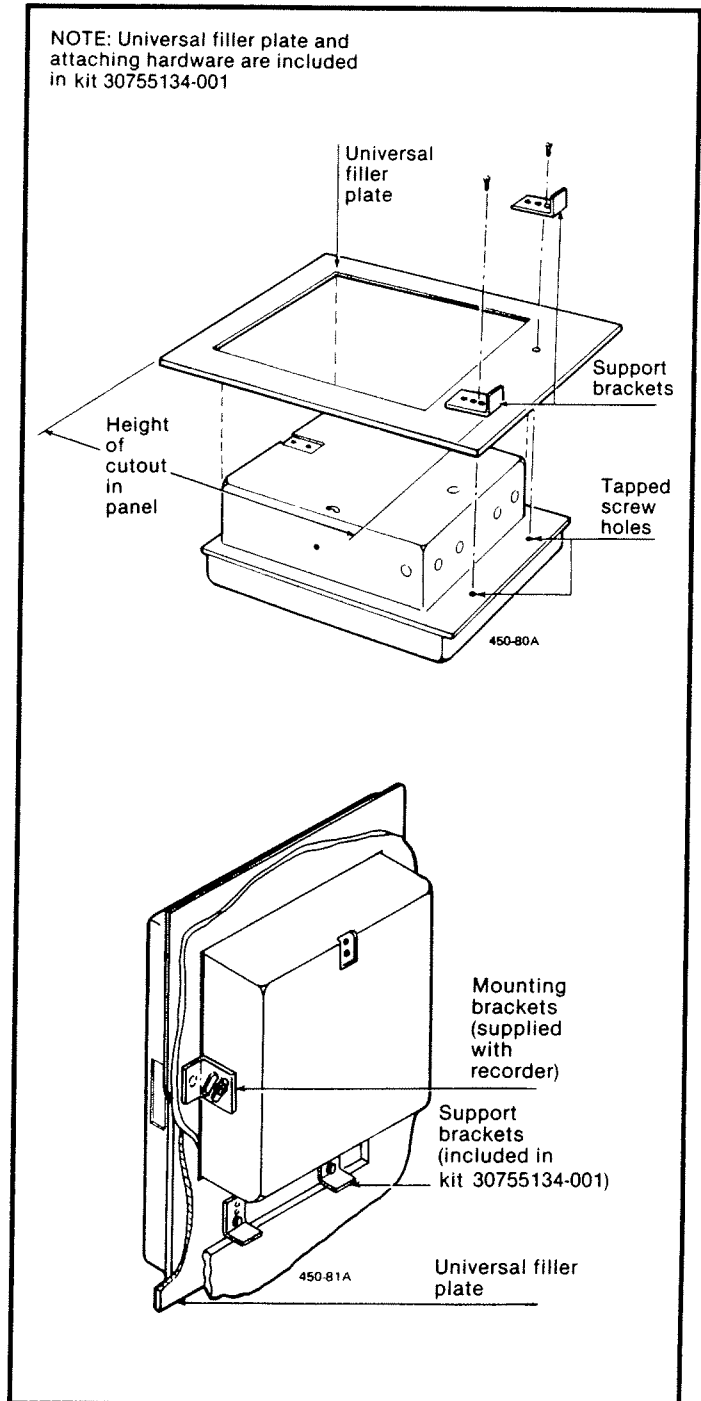

2 Mounting Your Recorder – Continued

C. Flush in Panel (Using an Existing Panel Cutout) -- Continued

PROCEDURE C-2 -- Cutout Made for Kent Model 105M

Materials Required: Mounting Hardware supplied with recorder.

1. Drill two 1/4-inch holes in panel below cutout as shown in figure at right. These holes are for 10-32 screws to be inserted from back of panel into threaded inserts in back of recorder case.

NOTE: If panel is more than 1/4-inch thick, substitute 10-32 × 1/2-inch long screws for the 3/8-inch long screws supplied with the recorder.

2. While supporting recorder, insert it through panel cutout and orient case so that threaded inserts at bottom of case align with holes drilled in panel.
3. From rear of panel, insert two 10-32 pan head screws of appropriate length into threaded inserts in recorder case.
4. Use mounting hardware supplied with recorder and see Steps 3, 4 in B. Flush in Panel (New Panel Cutout) to complete mounting procedure.

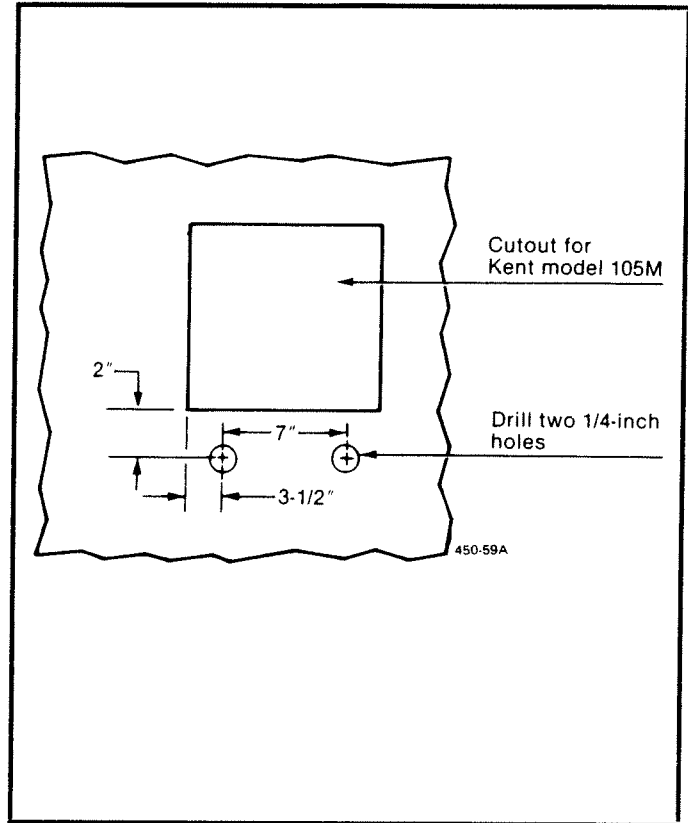

2 Mounting Your Recorder – Continued

D. On Surface (of Panel or Wall)

Materials Required:

- Mounting hardware supplied with recorder.
- Screws (3) must be supplied by user, for attaching mounting hardware (brackets and support hook) to panel or wall.

1. Using two flat-head 10-32 × 1/4-inch screws supplied with recorder, fasten support hook into recess at back of recorder case as shown in figure at right.
2. Using 1/4-20 × 1/2-inch hex screws and lockwashers, attach a mounting bracket to each side of case. Leave screws slightly loose so as to permit some adjustment of brackets.
3. On panel, mark locations for three holes, as shown by hole pattern in figure at right.
4. Using drill of appropriate size for user-supplied screws, drill a hole in front of panel for eye of support hook.
5. Insert screw for support hook into panel, allowing screw head to protrude approximately 5/16 inch.
6. Hang recorder on screw by support hook. Ensure that locations for other two holes (marked in Step 3) are correct. If not, ensure that recorder is aligned vertically, and use brackets as templates to mark proper locations.
7. Remove recorder from panel and drill other two holes.
8. Hang recorder on screw by support hook and insert other two user-supplied screws through brackets into panel. Tighten two hex screws that attach brackets to case.

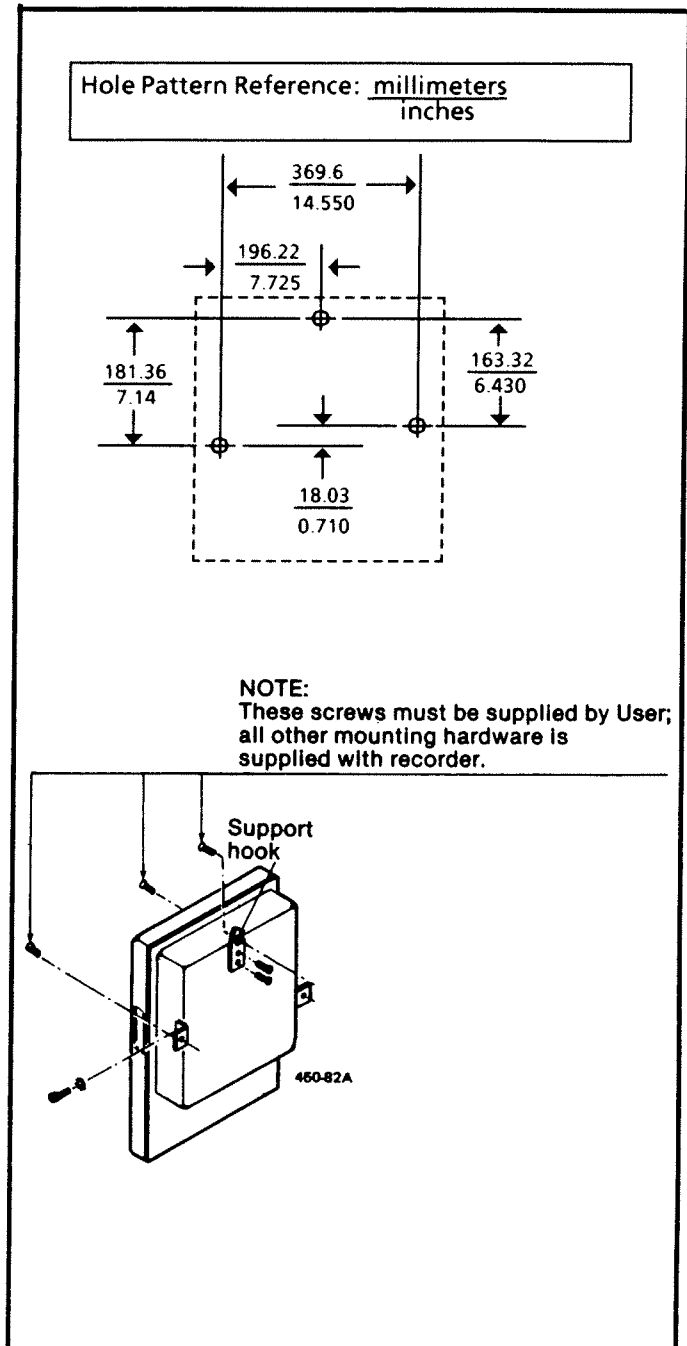

3 Wiring

A. Connecting Power

WARNING: Be sure that line voltage is OFF before connecting power wires to recorder.

1. Open recorder door. Loosen captive screw in chart plate and swing plate out.
2. Locate connector J9 on bottom edge of Main PCB.
3. Remove unwired plug from J9.
4. Run power wires separately through second conduit from right.
5. Strip 1/4-inch maximum of insulation from end of each wire.
6. Loosen screws in plug J9 terminals and position plug as you would to plug it into J9.

CAUTION: To avoid damaging the recorder, be sure that you install the power wires in the correct screw clamps for the given supply voltage rating -- 120 or 240 Vac.

7. a. For 120 Vac, insert green wire (G) in first screw clamp from right, white wire (L3) in second screw clamp from right, and black wire (L2) in third screw clamp from right. Tighten screws to secure wires.
- b. For 240 Vac, insert green wire (G) in first screw clamp from right, white wire (L3) in second screw clamp from right, and black wire (L1) in fourth screw clamp from right. Tighten screws to secure wires.
8. Dress wires for as little slack as possible. This keeps noise signal on these wires from bypassing built-in suppression. Also, don't bundle any low-level signal wires with the power wires. See application Note 48-51-07-04 for details about noise interference prevention.
9. Insert wired plug into J9.

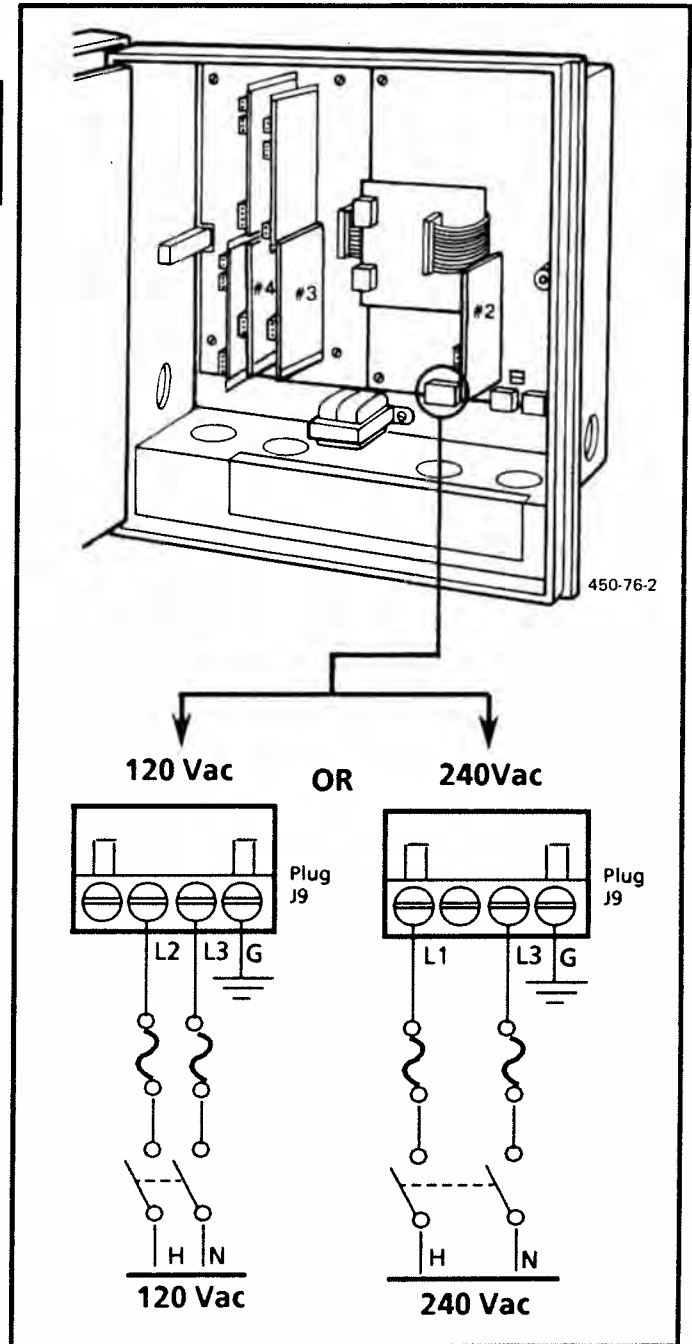

3 Wiring – Continued

B. Connecting Input 1

Prerequisites:

- Table I = 1XXX
- Thermocouple, RTD, mV or 0-5 Vdc input
- Door and chart plate are opened

1. Locate connector J6 on bottom right edge of Main PCB.
2. Remove unwired plug from J6.
3. Run input wires through desired knockout -- but don't bundle them with power wires.
4. Locate jumper pin positions W1 and W2 (if supplied) on main PCB. Depending on type of input, install, reposition, or remove jumper from W1/W2 positions as noted below:

Input Type	Jumper Location
Thermocouple	W1
RTD	W2
mV	--
0-5 Vdc	--
4-20 mA	--
0-10 Vdc	--

If jumper isn't required, a convenient way to save it for future use is to install the jumper on only one pin so one end of the jumper is free and other pin(s) is (are) "exposed."

5. Strip 1/4-inch of insulation from end of each wire.
6. Loosen screws in plug J6 terminals and position plug as you would to plug it into J6.
7. Insert wires in appropriate screw clamps for applicable input type as shown. Tighten screws to secure wires.
8. Insert wired plug into J6.

CAUTION: If you have multiple inputs, do not interchange Plug J2 on 2nd, 3rd, or 4th input PCB with plug J6 on main PCB. While plugs J2 and J6 are physically identical, input signal polarity is reversed and recorder will not operate properly.

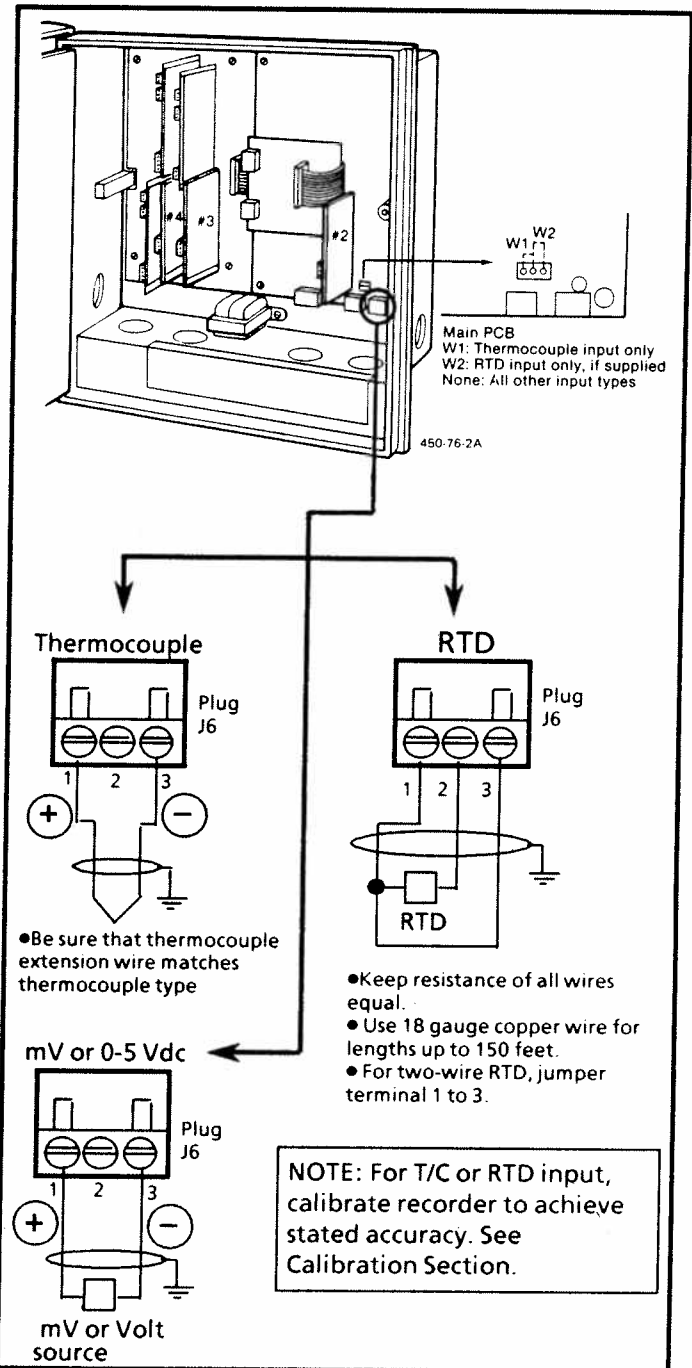

3 Wiring – Continued

B. Connecting Input 1 -- Continued Prerequisites:

- Table 1 = 2XXX
- 4-20mA input
- Door and chart plate are opened

NOTE: Connector J10 on the Main PCB can be used to provide 24 Vdc power to up to two field transmitters (without power) which are supplying 4-20 mA input signals to the recorder. (1.2W @ 24 Vdc = 50 mA available.)

1. Locate connector J6 on bottom right edge of Main PCB.
2. Remove unwired plug from J6.
3. Run input wires through desired knockout -- but don't bundle them with power wires.
4. Strip 1/4-inch of insulation from end of each wire.
5. Loosen screws in plug J6 terminals and position plug as you would to plug it into J6.
6. a. For transmitters with power, insert wires in appropriate screw clamps and install 250 ohm resistor / Transorb assembly, supplied with recorder, across wires as shown. Tighten screws to secure wires.
- b. For transmitters which require power, remove unwired plug from J10. Wire transmitter power to J10 and input to J6, which still requires 250 ohm resistor / Transorb assembly, as shown. Tighten screws in plugs to secure wires.
7. Install wired plug(s) into J6. and J10, as applicable.
8. Be sure that neither W1 nor W2 (if supplied) is installed -- See previous page.

CAUTION: If you have multiple inputs, do not interchange Plug J2 on 2nd, 3rd, or 4th input PCB with plug J6 on main PCB. While plugs J2 and J6 are physically identical, input signal polarity is reversed and recorder will not operate properly.

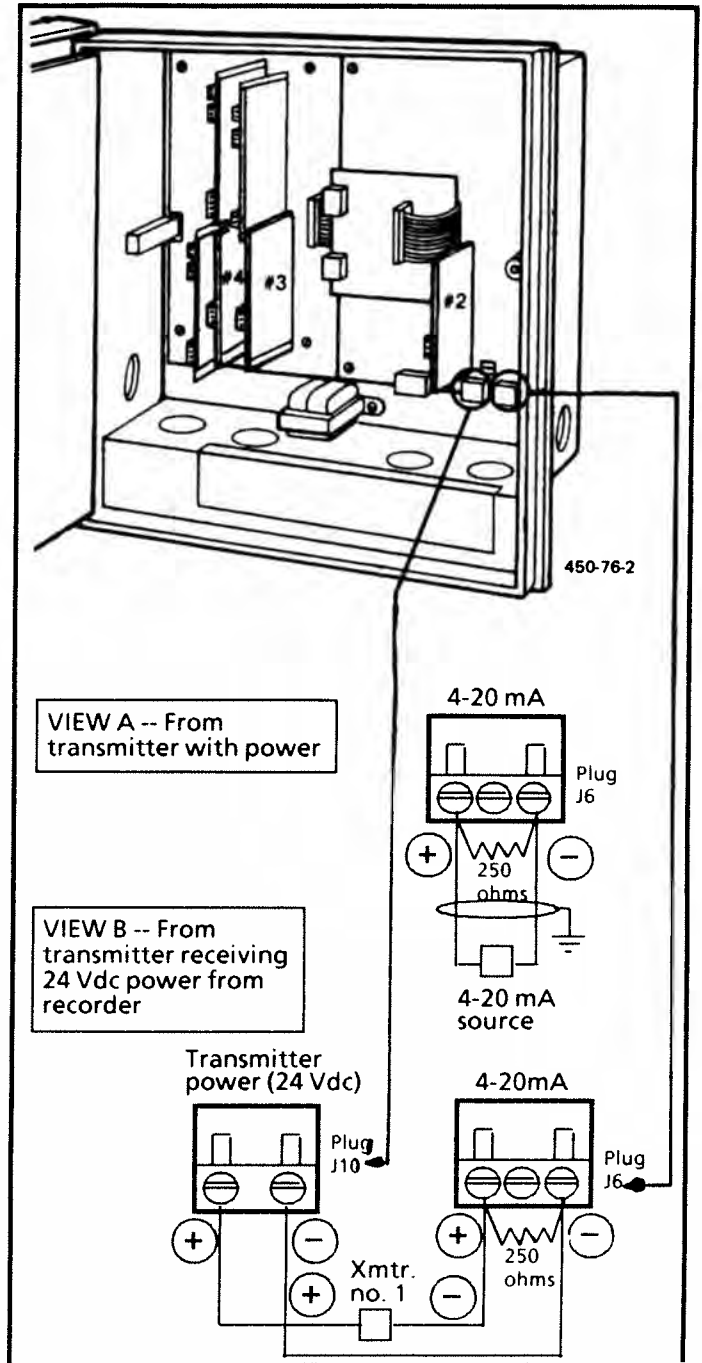

3 Wiring -- Continued

B. Connecting Input 1 -- Continued

Prerequisites:

- Table 1 = 3XXX
- 0-10 Vdc input
- Door and chart plate are opened

1. Locate connector J6 on bottom right edge of Main PCB.
2. Remove unwired plug from J6. and replace it with modified 4-screw plug from bag of accessories supplied with recorder.
3. Run input wires through desired knockout -- but don't bundle them with power wires.
4. Strip 1/4-inch of insulation from end of each wire.
5. Loosen screws in plug J6 terminals and position plug as you would to plug it into J6.
6. Insert wires into appropriate screw clamps and install two 100K ohm resistors (30755232-001) from bag of accessories supplied with recorder across wires as shown. Tighten screws to secure wires.
7. Install wired plug into J6. Since J6 has only three receptacles, one of modified plug connectors is designed to slide outside J6 when plug is installed.
8. Be sure that neither W1 nor W2 (if supplied) is installed -- See page for Thermocouple, RTD, mV or 0-5 Vdc input.

CAUTION: If you have multiple inputs, do not interchange Plug J2 on 2nd, 3rd, or 4th input PCB with plug J6 on main PCB. While plugs J2 and J6 are physically identical, input signal polarity is reversed and recorder will not operate properly.

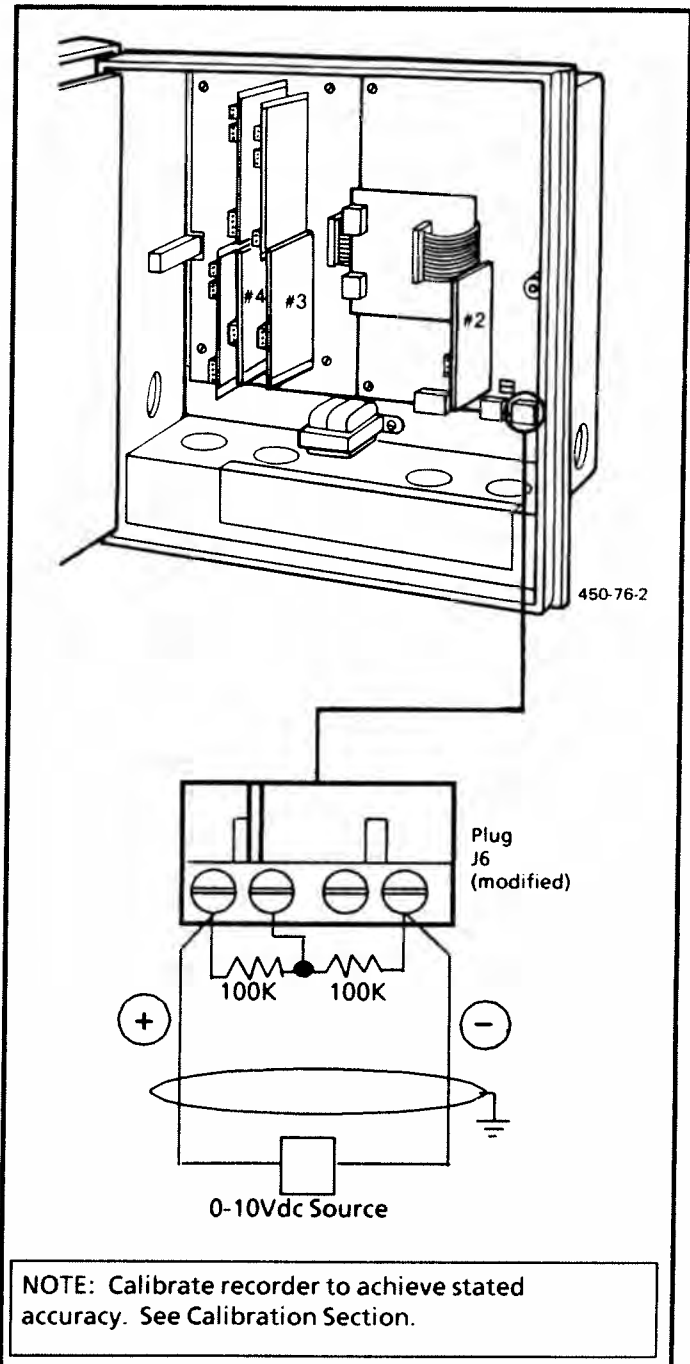

3 Wiring – Continued

C. Connecting Input 2, 3 or 4 Prerequisites:

- Table 1 = X1XX, X11X, or X111
- Thermocouple, RTD, mV or 0-5 Vdc input
- Door and chart plate are opened

NOTE: Polarity for Inputs #2, 3 and 4 is identical.

1. Locate connector J2 on second input PCB.
2. Remove unwired plug from J2.
3. Run input wires through desired knockout -- but don't bundle them with power wires.
4. Locate jumper pin positions W1 and W2 (if supplied) on second input PCB. Depending on type of input, install, reposition, or remove jumper from W1/W2 positions as noted below:

Input Type	Jumper Location
Thermocouple	W1
RTD	W2
mV	--
0-5 Vdc	--
4-20 mA	--
0-10 Vdc	--

If jumper isn't required, a convenient way to save it for future use is to install the jumper on only one pin so one end of the jumper is free and other pin(s) is (are) "exposed."

5. Strip 1/4-inch of insulation from end of each wire.
6. Loosen screws in plug J2 terminals and position plug as you would to plug it into J2.
7. Insert wires in appropriate screw clamps for applicable input type as shown. Tighten screws to secure wires.
8. Insert wired plug into J2.
9. Repeat Steps 1-8 for third and fourth input PCBs, as applicable.

CAUTION: If you have multiple inputs, do not interchange Plug J2 on 2nd, 3rd, or 4th input PCB with plug J6 on main PCB. While plugs J2 and J6 are physically identical, input signal polarity is reversed and recorder will not operate properly.

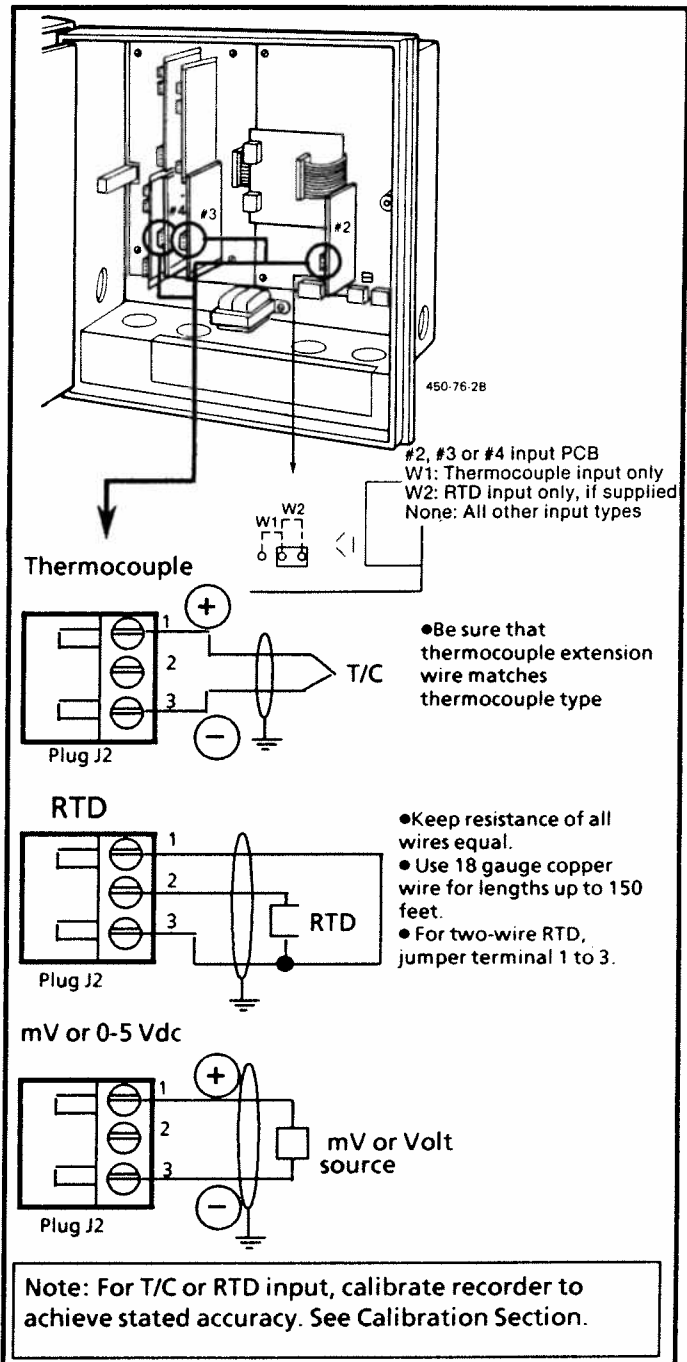

3

3 Wiring – Continued

C. Connecting Input 2, 3 or 4 -- Continued

Prerequisites:

- Table 1 = X2XX, X22X, or X222
- 4-20 mA input
- Door and chart plate are opened

NOTE: Connector J10 on the Main PCB can be used to provide 24 Vdc power to up to two field transmitters (without power) which are supplying 4-20 mA input signals to the recorder. (1.2W @ 24 Vdc = 50 mA available.)

1. Locate connector J2 on second input PCB.
2. Remove unwired plug from J2.
3. Run input wires through desired knockout -- but don't bundle them with power wires.
4. Strip 1/4-inch of insulation from end of each wire.
5. Loosen screws in plug J2 terminals and position plug as you would to plug it into J2.
6.
 - a. For transmitters with power, insert wires in appropriate screw clamps and install 250 ohm resistor / Transorb assembly, supplied with recorder, across wires as shown. Tighten screws to secure wires.
 - b. For transmitters which require power, remove unwired plug from J10. Wire transmitter power to J10 and input to J2, which still requires 250 ohm resistor / Transorb assembly, as shown. Tighten screws in plugs to secure wires.
7. Install wired plug(s) into J2. and J10, as applicable.
8. Be sure that neither W1 nor W2 (if supplied) is installed -- See previous page.
9. Repeat Steps 1-8 for third and fourth input PCBs, as applicable.

CAUTION: If you have multiple inputs, do not interchange Plug J2 on 2nd, 3rd, or 4th input PCB with plug J6 on main PCB. While plugs J2 and J6 are physically identical, input signal polarity is reversed and recorder will not operate properly.

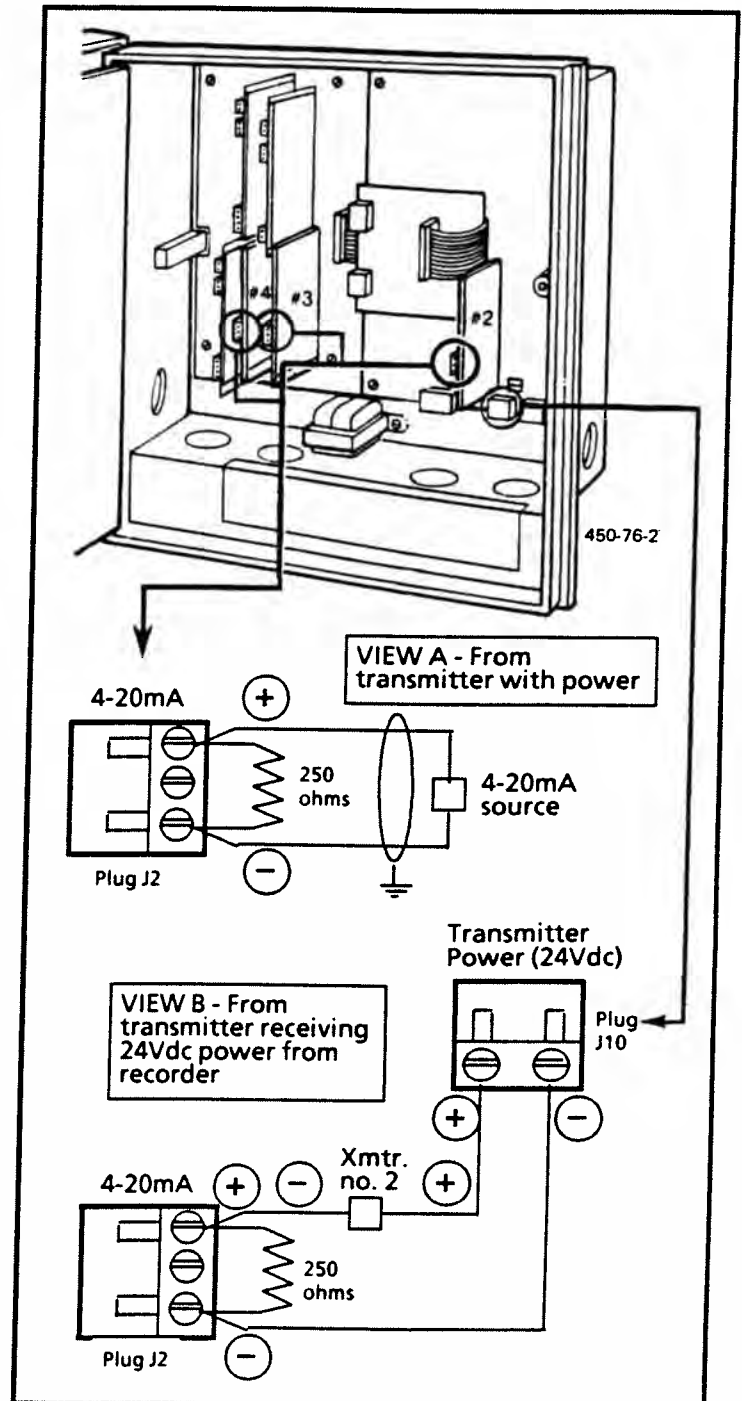

3 Wiring -- Continued

C. Connecting Input 2, 3 or 4 -- Continued

Prerequisites:

- Table 1 = X3XX, X33X, or X333
- 0-10 Vdc input
- Door and chart plate are opened

1. Locate connector J2 on second input PCB.
2. Remove unwired plug from J2. and replace it with modified 4-screw plug from bag of accessories supplied with recorder.
3. Run input wires through desired knockout -- but don't bundle them with power wires.
4. Strip 1/4-inch of insulation from end of each wire.
5. Loosen screws in plug J2 terminals and position plug as you would to plug it into J2.
6. Insert wires into appropriate screw clamps and install two 100K ohm resistors (30755232-002) from bag of accessories supplied with recorder across wires as shown. Tighten screws to secure wires.
7. Install wired plug into J2. Since J2 has only three receptacles, one of modified plug connectors is designed to slide outside J2 when plug is installed.
8. Be sure that neither W1 nor W2 (if supplied) is installed -- See page for Thermocouple, RTD, mV or 0-5 Vdc input 2.
9. Repeat Steps 1-8 for third and fourth input PCBs, as applicable.

CAUTION: If you have multiple inputs, do not interchange Plug J2 on 2nd, 3rd, or 4th input PCB with plug J6 on main PCB. While plugs J2 and J6 are physically identical, input signal polarity is reversed and recorder will not operate properly.

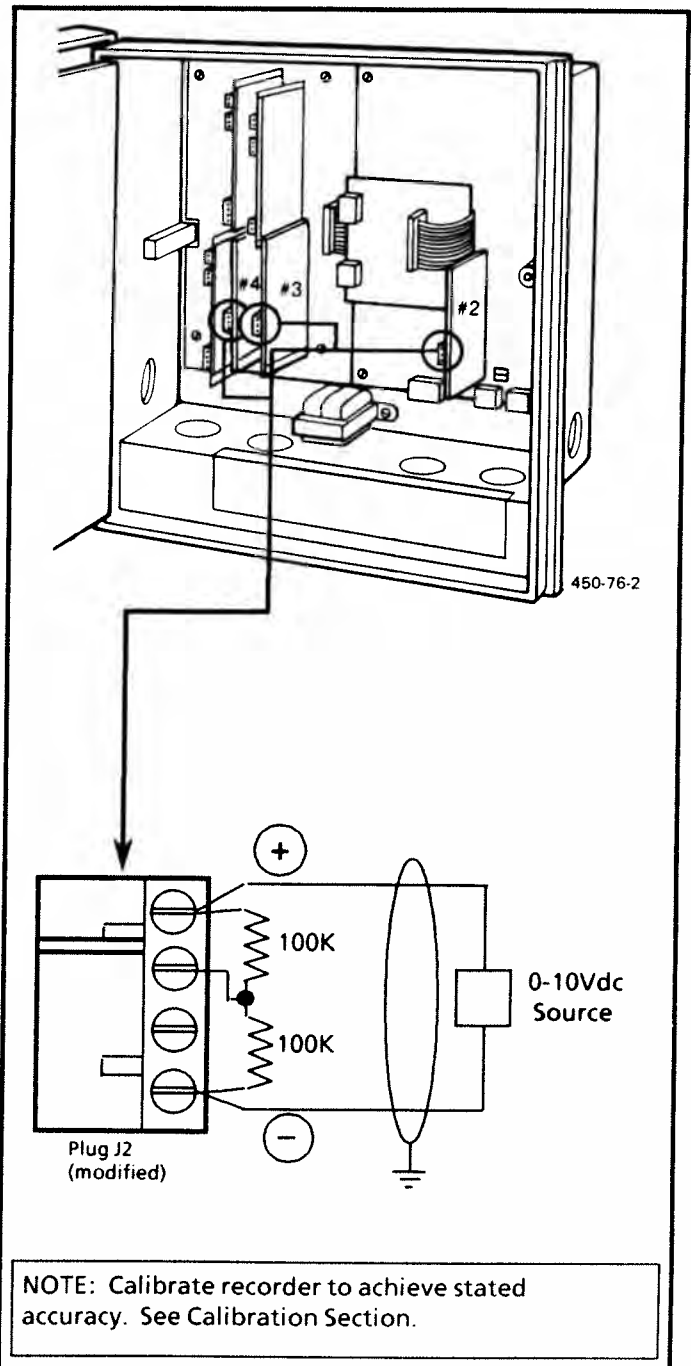

3 Wiring – Continued

D. Connecting Control Output #1/#2

Prerequisites:

- Table II = 1X or 4X/11, 14, 41 or 44
- 4-20 mA output
- Door and chart plate are opened

1. Locate connector J1 near top of control output #1 PCB.
2. Remove unwired plug from J1.
3. Run output wires through desired knockout.
4. Strip 1/4-inch of insulation from end of each wire.
5. Loosen screws in plug J1 terminals and position plug as you would to plug it into J1.
6. Observing polarity, insert wires into screw clamps as shown. Tighten screws to secure wires.
7. Install wired plug into J1.
8. Repeat Steps 1-7 for control output #2 PCB, as applicable.

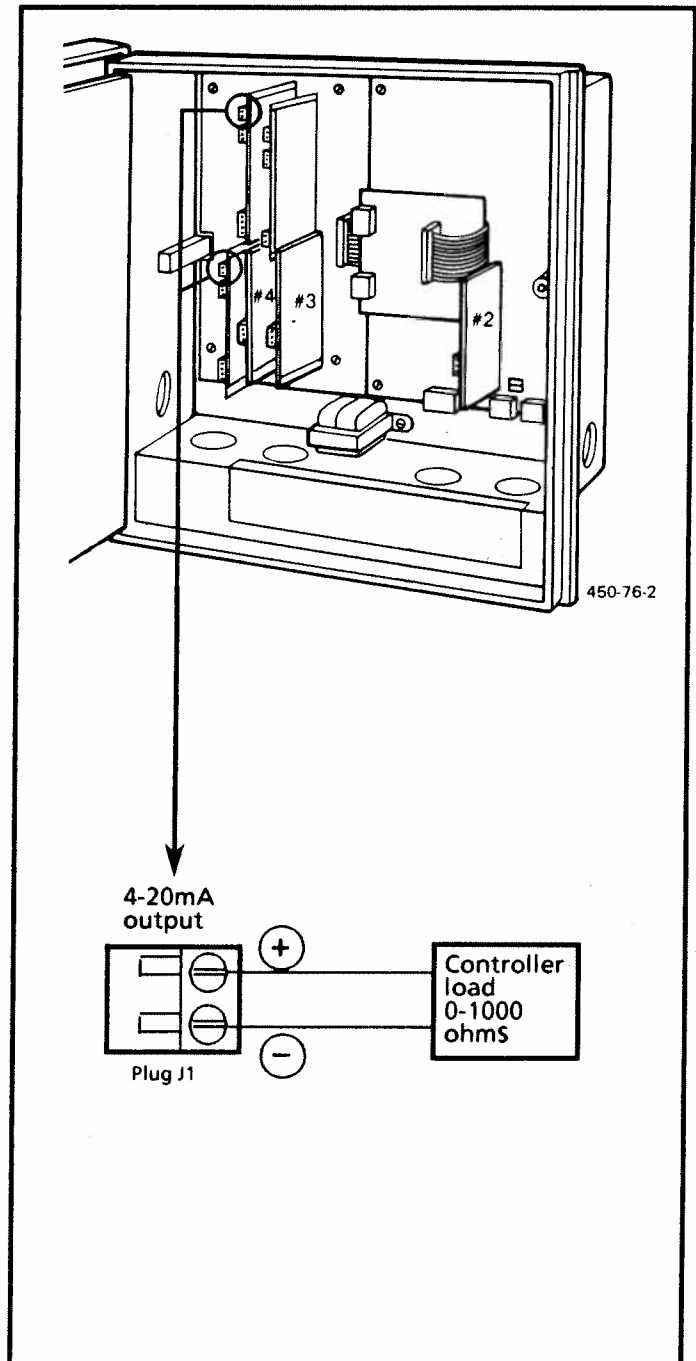

3 Wiring – Continued

D. Connecting Control Output #1/#2 -- Continued

Prerequisites:

- Key Number = DR 450T
- Table II = 1X or 4X/11,14, 41, or 44
- Position Proportional Output
- Door and chart plate are opened

1. Locate connectors J2 and J5 on control output #1 PCB.
2. Remove unwired plugs from J2 and J5.
3. Locate jumper positions W2/W3 and W4/W5 below connector J5 on PCB. Note that you may want to remove plug-in output #1 PCB for better access to jumpers. Be sure to tag and remove all plug connections to PCB before removing it. Position jumpers as shown for desired relay contact action and reinstall PCB.
4. Run feedback slidewire and motor drive wires through desired knockouts.
5. Strip 1/4-inch of insulation from end of each wire.
6. Loosen screws in plug J2 terminals and position plug as you would to plug it into J2.
7. Insert wires from motor's feedback slidewire into screw clamps as shown. Tighten screws to secure wires.
8. Loosen screws in plug J5 terminals and position plug as you would to plug it into J5.
9. Insert wires for motor drive into screw clamps as shown. Tighten screws to secure wires.
10. Install wired plugs into J2 and J5, as applicable.
11. Repeat Steps 1-10 for control output #2 PCB, as applicable

NOTE: Be sure to calibrate the position proportional output so that the increase and decrease relays operate properly with respect to the position of the external feedback slidewire. See the calibration section in this manual.

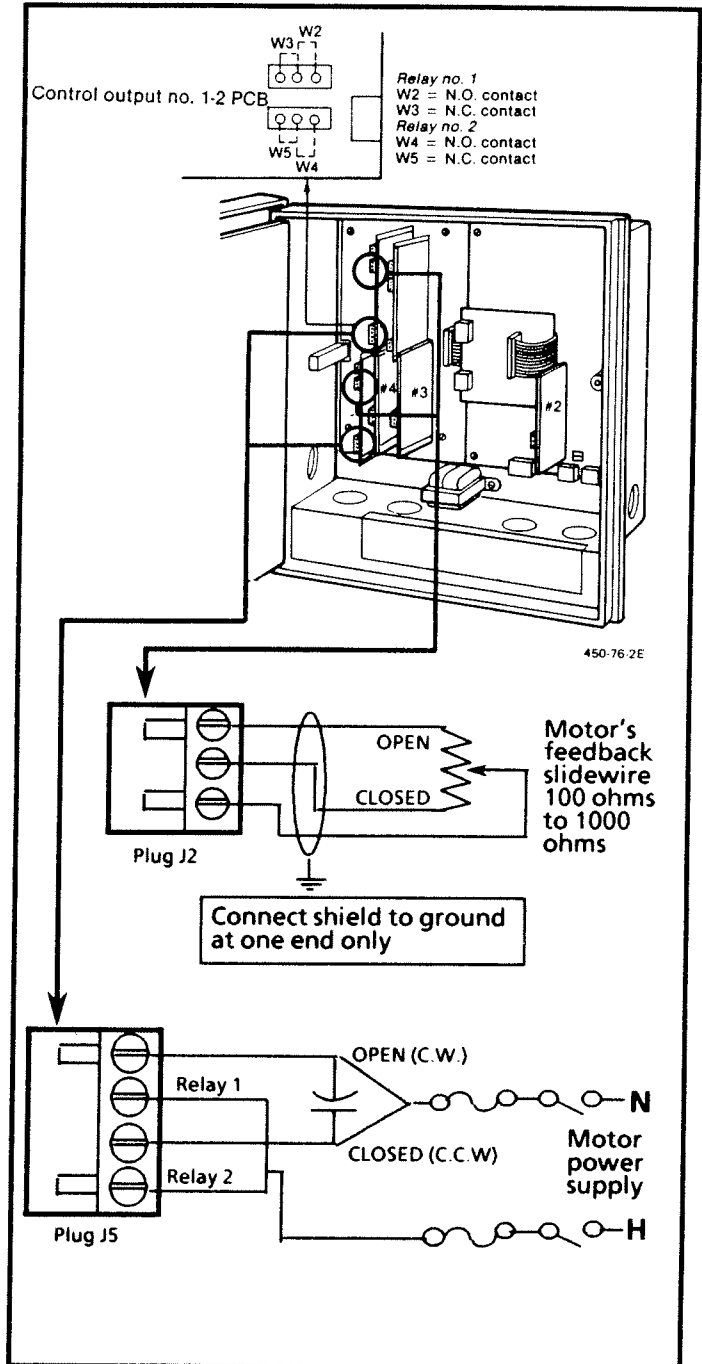

3 Wiring – Continued

D. Connecting Control Output #1/#2 -- Continued

Prerequisites:

- Key Number = DR 450T
- Table II = 1X or 4X/11, 14, 41 or 44
- Relay Output (Including time proportional and 3-position step applications)
- Door and chart plate are opened

1. Locate connector J5 on control output #1 PCB.
2. Remove unwired plug from J5.
3. Locate jumper positions W2/W3 and W4/W5 below connector J5 on PCB. Note that you may want to remove plug-in output #1 PCB for better access to jumpers. Be sure to tag and remove all plug connections to PCB before removing it. Position jumpers as shown for desired relay contact action and reinstall PCB.
4. Run relay load wires through desired knockout.
5. Strip 1/4-inch of insulation from end of each wire.
6. Loosen screws in plug J5 terminals and position plug as you would to plug it into J5.
7. Insert relay wires and relay power into appropriate screw clamps for single or duplex action as shown. Tighten screws to secure wires.
8. Install wired plug into J5.
9. Repeat Steps 1-8 for control output #2 PCB, as applicable.

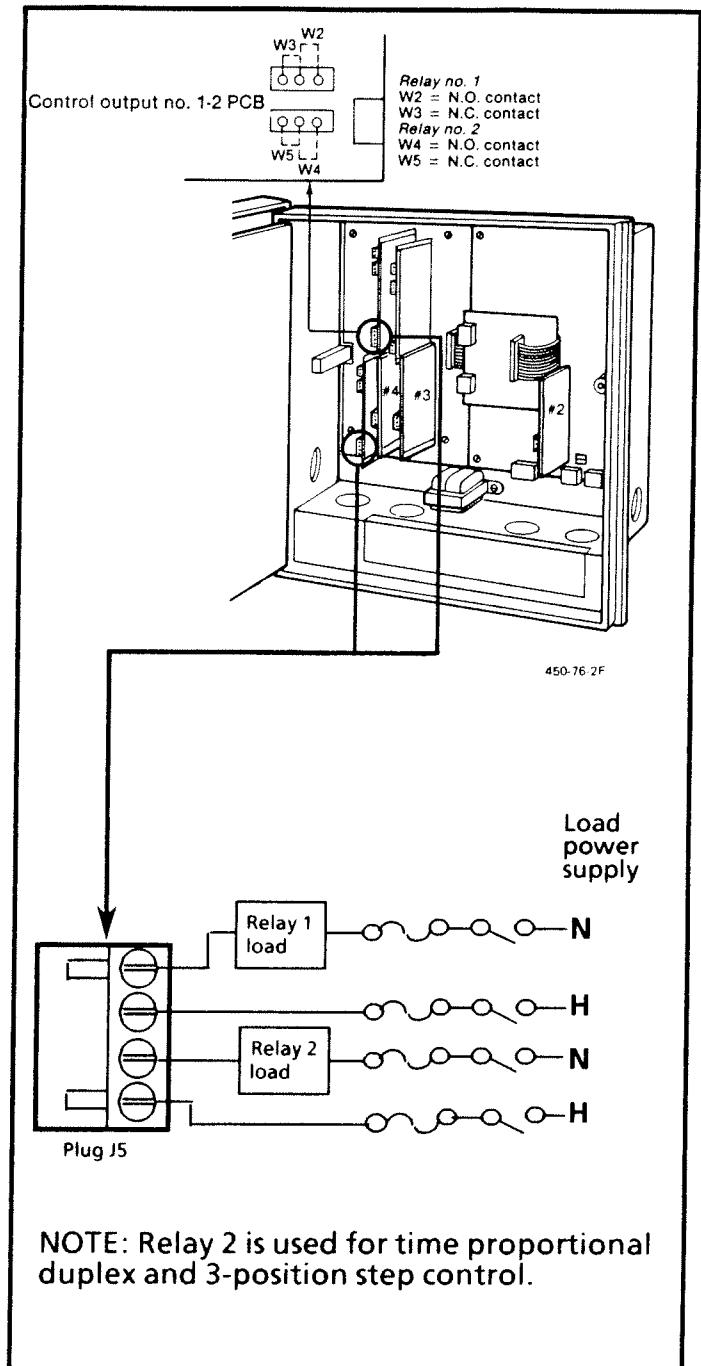

3 Wiring -- Continued

E. Connecting No. 1 & 2 Alarm Outputs & Digital Inputs

Prerequisites:

- Table III = XX1*
- Door and chart plate are opened

* If Table III = 002 or 003, see Appendix D to wire no. 3, 4, 5, or 6 alarm outputs.

1. Locate connectors J3 and J4 on alarm output /digital input PCB.
2. Remove unwired plug from J3.
3. Run digital input wires through desired knockout.
4. Strip 1/4-inch of insulation from end of each wire.
5. Loosen screws in plug J3 terminals and position plug as you would to plug it into J3.
6. Insert wires for digital inputs into appropriate screw clamps as shown. Note that you can wire contacts in an and/or fashion so both contacts or either contact initiates configured action. Tighten screws to secure wires.
7. Remove unwired plug from J4.
8. Run alarm output wires through desired knockout.
9. Strip 1/4-inch of insulation from end of each wire.
10. Insert wires for alarm devices into appropriate screw clamps as shown. Tighten screws to secure wires.
11. Locate jumper positions W1/W2 and W3/W4 on PCB. Reposition jumpers as shown for desired relay contact action.
12. Install wired plugs J3 and J4 into J3 and J4, respectively.

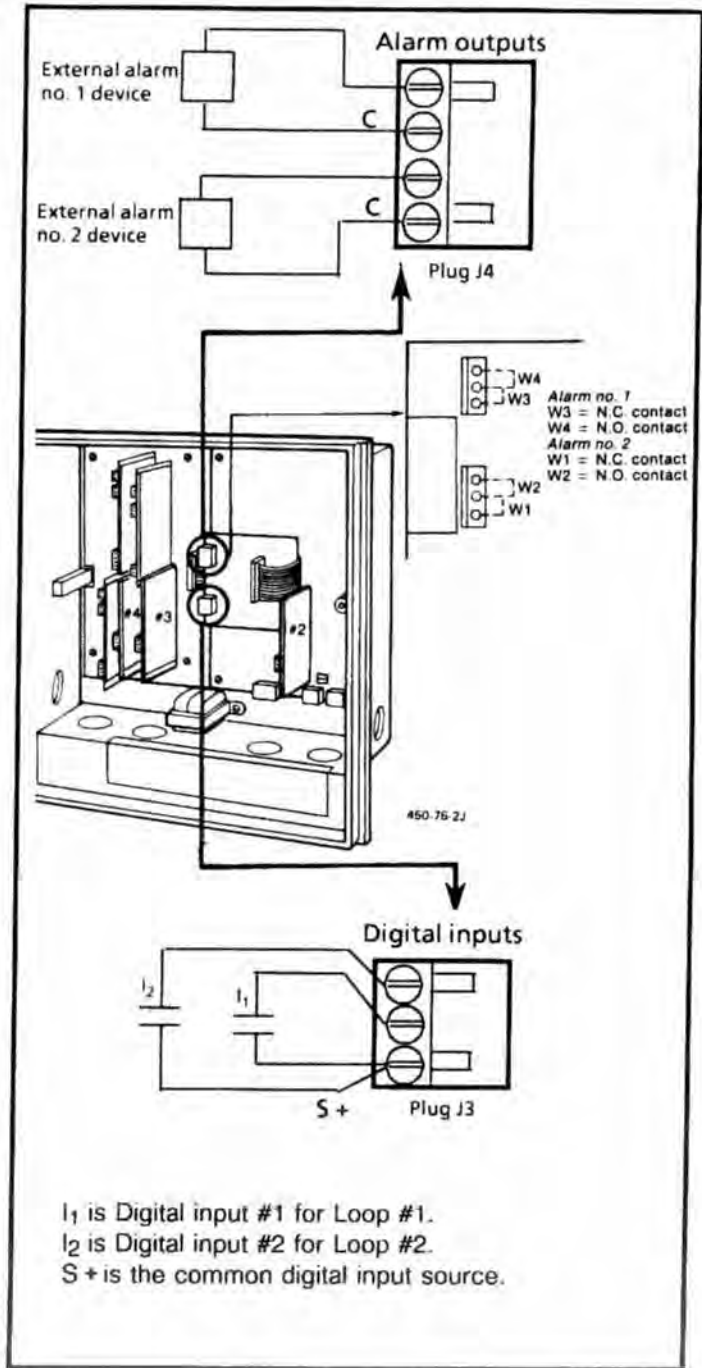

3 Wiring – Continued

F. DMCS Communications Prerequisites:

- Key number = DR 450T
- Table III = 1XX
- Door and chart plate are opened

1. Locate connector J1 on communications PCB.
2. Remove unwired plug from J1.
3. Run communications wires through desired knockout.
4. Strip 1/4-inch of insulation from end of each wire.
5. Loosen screws in plug J1 terminals and position plug as you would to plug it into J1.
6. Insert shielded wires for communications into appropriate screw clamps as shown. Tighten screws to secure wires.
7. Install wired plug J1 into J1 connector.

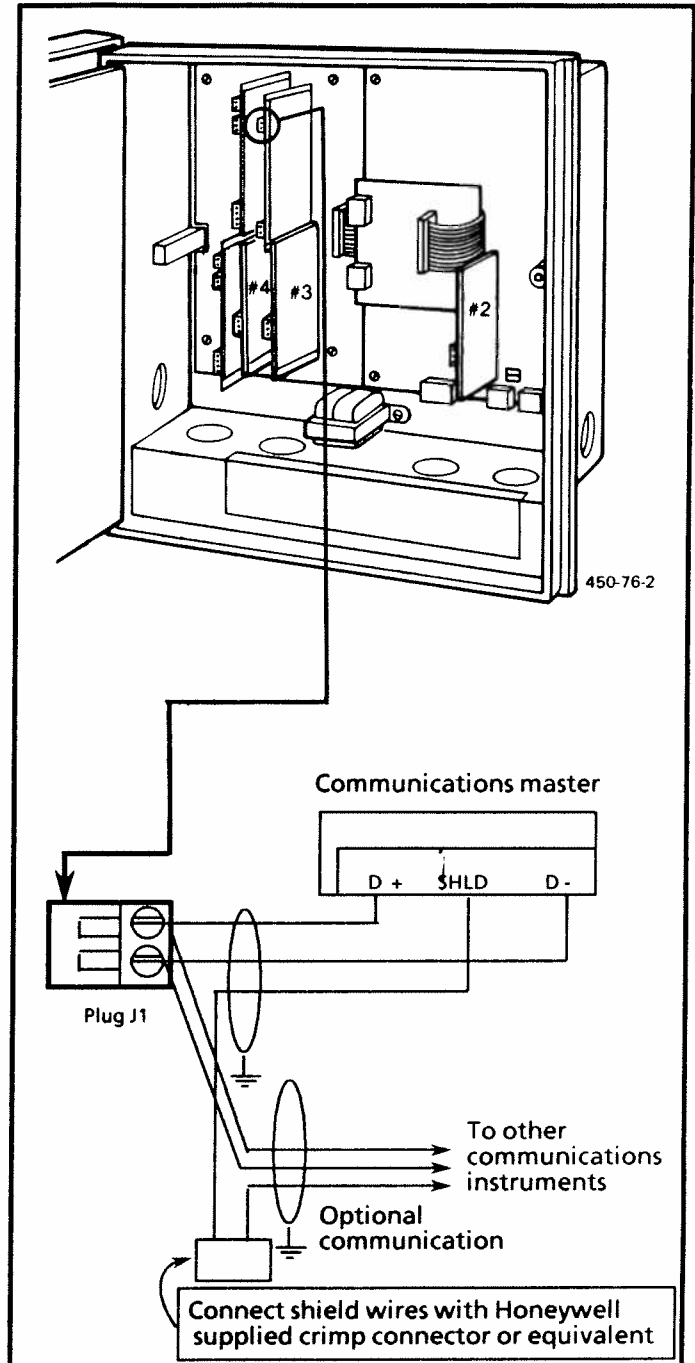

How to Apply Digital Instrumentation in Severe Electrical Noise Environments

Application Notes

Introduction

Products which incorporate digital technology provide recognized performance advantages over conventional analog instrumentation used for process control. These advantages can result in better product uniformity and greater overall efficiency when used correctly. There are, however, certain guidelines regarding installation and wiring which must be carefully followed in order to achieve this performance. In addition to the traditional precaution of the separation of signal and power wiring in separate conduits, other measures must be taken to minimize the effects of electromagnetic interference (EMI) and radio frequency interference (RFI) on the operation of the equipment. Otherwise, if high level, short duration, noise spikes are permitted to enter the digital equipment, the noise can be transferred into the system's logic networks and can be misinterpreted as signal data, resulting in erroneous system operation and other unpredictable responses.

Potential Noise Sources

Noise can enter electronic equipment via three methods of coupling, namely:

- capacitive (or electrostatic)
- inductive (or magnetic)
- impedance

Capacitive and inductive coupling have the same essential effect -- they couple current or voltage, without any actual connection of the two circuits. Impedance coupling requires a connection between the two circuits.

Typical noise-generating sources that could affect electronic equipment through capacitive and inductive coupling include:

- Relay coils
- Solenoids
- AC power wires -- particularly at or above 100 Vac
- Current carrying cables
- Thyristor field exciters
- Radio frequency transmissions

Impedance couple noise may enter by way of the lines used to power the digital equipment or by way of improper grounding. Most power lines, at typical industrial locations, are far from noise-free. The noise on them can be generated in many ways, but are nearly always associated with switching circuits of some nature. These include:

- large relays
- contactors
- motor starters
- business and industrial machines
- power tools
- HID (High Intensity Discharge) lights
- Silicon Controlled Rectifiers (SCRs) that are phase angled fired.

These devices generate noise by lowering the line voltage during energization when large currents are drawn for short periods of time.

Prevention of Noise Interference

There are three ways to prevent electrical noise from interfering with the operation of the electronic digital equipment. One is to suppress the noise at its source. This is the most effective but also the most difficult because it is not easy to identify all of the potential noise sources in a typical industrial installation. Therefore, "suppression" is usually a last resort for those extreme situations where the other methods are insufficient by themselves.

The second method is to prevent noise from getting on the signal and power lines that are connected to the equipment. This is achieved by proper separation and shielding of those lines. In some cases separate power lines or special power line regulation or filtering may be required for satisfactory electronic digital equipment operation. It is the responsibility of the installer to follow good wiring practices.

The third method is to design the digital equipment with a high degree of noise rejection built-in. This includes housing the equipment in a case that will provide shielding, liberal use of noise rejection filters and opto-isolators, and the use of noise suppressors on potential noise sources within the equipment itself. This, of course, is the responsibility of the manufacturer who usually performs extensive laboratory and field testing of newly designed digital equipment to insure the adequacy of its immunity to noise. As a minimum requirement, the equipment should be able to pass the tests outlined in the IEEE Standard 472-1974 (Surge Withstand Capacity Tests).

Recommended Wiring Practices

- All wiring must conform to local codes and practices.
- Wires carrying similar types of signals (Table 1) may be bundled together, but bundles with different types of signals must be kept separated to prevent inductive or capacitive coupling.
- For distances over five (5) feet, and when shielding is recommended, use a separate metal tray or conduit for each bundle. Where conduits or trays are not practical, use twisted wires with a metal overbraid and provide physical separation of at least one foot.
- Tray covers must be in continuous contact with the side rails of the trays.
- When unlike signal levels must cross, either in trays or conduits, they should cross at a 90-degree angle and at a maximum spacing. Where it is not possible to provide spacing, a grounded steel barrier or grid should be placed between the unlike levels at the crossover points.
- Trays containing low level wiring should have solid bottoms and sides. Tray covers must be used for complete shielding. Tray cover contact with side rails must be positive and continuous to avoid high reluctance air gaps, which impair shielding. Trays for low level cables should be metal and solidly grounded.
- Wires containing low level signals should not be routed near any of the following:
 - contactors
 - motors
 - generators
 - radio transmitters
 - wires carrying high current that is being switched on and off
- Use a 12-gage (or heavier) insulated stranded wire for the ground connection. Attach it firmly to a proven good earth ground such as a metal stake driven into the ground.
- All shields should be grounded at one end only -- preferably the instrument end.

TABLE 1 -- External Wiring

Wire Function		Bundle No.	Are Shielded Twisted Wires Recommended?
No.	Type		
1 2 3	HIGH VOLTAGE Line Power Earth Ground Line Voltage Digital I/O	1	NO
4 5	ANALOG I/O Process Variable RTD Thermocouple dc Millivolts Low Level (< 100V) 4-20 mA dc 1-5 Vdc	2	YES
6 7	DIGITAL I/O Low Voltage (< 100V) Computer Interface	3	YES

Power Source

The AC power for the digital electronic equipment must be within the voltage and frequency limits specified for that equipment. Attempts to operate outside the specified limits will result in no performance. For those installations where the supply voltage will not stay within the specified limits; a ferro-resonant transformer, for voltage resolution, should be used.

For protection against noise, the AC source for the digital electronic equipment should be independent of all other loads especially when switching loads are involved. For example, it should not provide power for air-conditioning, convenience outlets, lighting, motors, or similar noise generating devices. To obtain electrical isolation (Figure 1) a separate transformer is required to supply power to the digital equipment. For additional noise and transient rejection, shielded primary and secondary windings may be required. And if necessary, power line filters may be added to attenuate noise signals that have a higher frequency than the power line frequency.

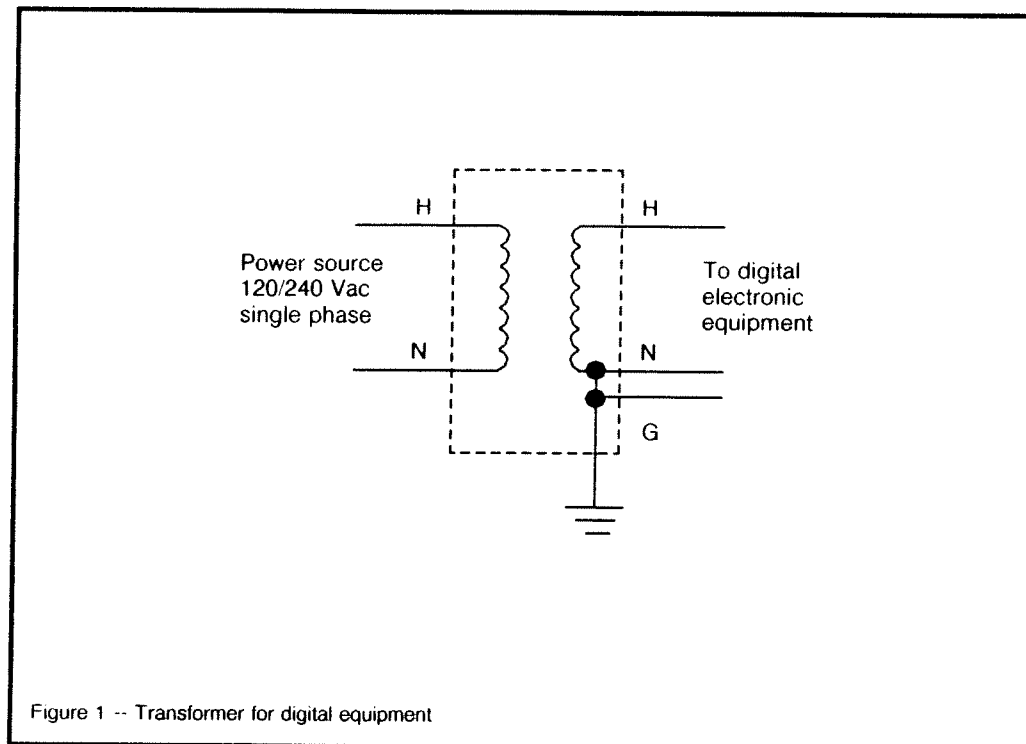

Noise Suppression at the Source

Generally speaking, when good wiring practices are used with well designed digital electronic equipment, no further noise protection is necessary. However, in some severe electrical environments, the magnitude of the electrical noise is so great that it must be suppressed at the source. In most control cabinets, the main sources of noise are motor starters, contactors, relays, and switch gear. For this reason, many manufacturers of these devices supply "surge suppressors" which mount directly on the noise source, for example, on the coil of a control relay or motor starter.

For those devices that do not have accessory "surge suppressors," resistance-capacitance (RC) circuits and/or voltage limiters such as metal varistors may be added when and where needed. This can be broken down into two categories, namely inductive loads (e.g., a relay switch in series with a relay coil) and contacts.

- **Inductive Coils:** Metal Oxide Varistors (MOVs) are recommended for transient suppression in inductive coils. An MOV is connected in parallel with the coil and is as close as physically possible to the coil (Figure 2). MOV devices (Table 2) are recommended for general purpose applications.

Additional protection may be provided by adding an RC circuit in parallel with the MOV. This consists of a 220 ohm resistor in series with a 0.5 microfarad, 1000V capacitor. The power rating of the resistor will depend on the voltage rating of the coil (Table 3).

TABLE 2 -- MOV Devices

Part Number	30732481-001	30732481-002
Maximum AC	130V	275V
Energy Pulse Rating	10 Joules	15 Joules
Supplier (General Electric)	V130LA10A	V275LA15A

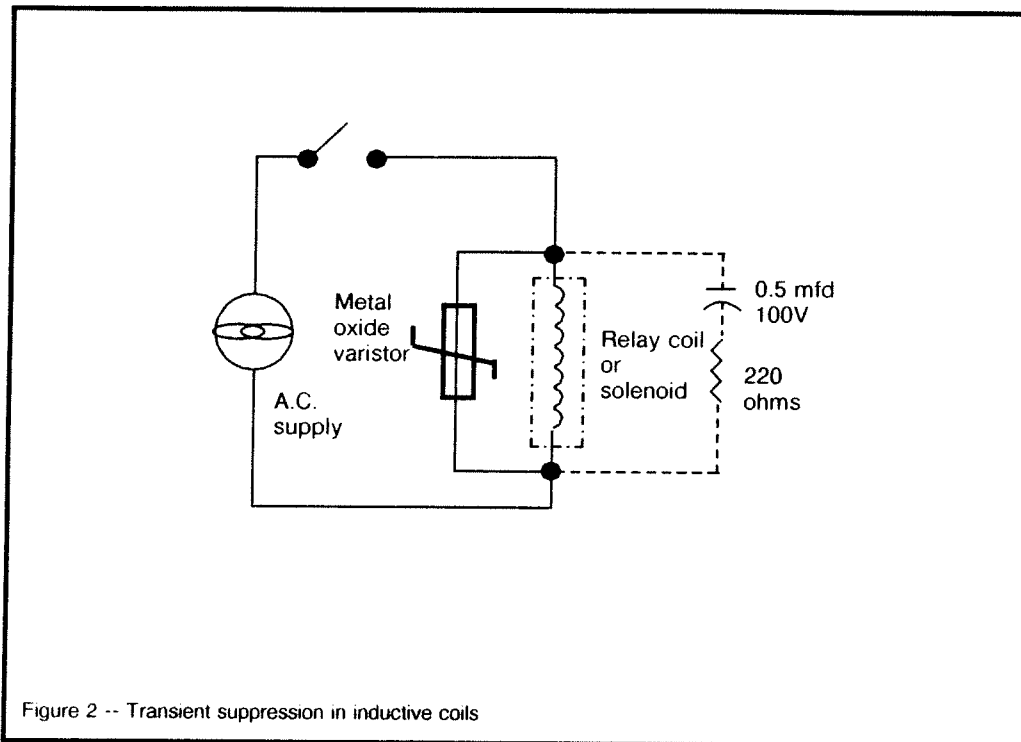

Figure 2 -- Transient suppression in inductive coils

TABLE 3 -- Coil Voltage vs Resistor Voltage Rating

Coil Voltage	Resistor Voltage Rating
115V	1/4 Watt
230V	1 Watt
460V	3 Watt
550V	5 Watt

- **Contacts:** When a contact interrupts an inductive load, a certain amount of energy is stored in the load. An MOV or RC circuit in parallel with the load provides a place where this energy may be dissipated. However, if there is no MOV or RC circuit, the energy may create a visible electrical arc across the open contacts. And this, in turn, results in electrical noise as well as damage to the contacts.

One way to eliminate this arc is to connect a resistor and capacitor across the contacts (Figure 3). A combination of 47 ohms and 0.1 microfarads (1000 Vdc) is recommended for circuits up to 3 amps and 300 Vac. And for voltage above 2000 Vac, an MOV across the contact may be added for extra protection.

For large load currents, a rule-of-thumb is to size the capacitor so that the number of microfarads equals the number of amperes in the load current, and the resistor is the same value as the load. This objective is to eliminate the visible arc.

Either discreet resistors and capacitors or packaged RC networks may be used. RC networks (47 ohms and 0.1 microfarad) are available from Electrocube Inc. (part number RG1782-3) and from Industrial Condensor Corporation.

In DC circuits, the power dissipation under steady-state condition can be eliminated by placing a diode (in series with a resistor) in parallel with the load (Figure 4). The value of R should be less than or equal to the DC resistance of the inductive load.

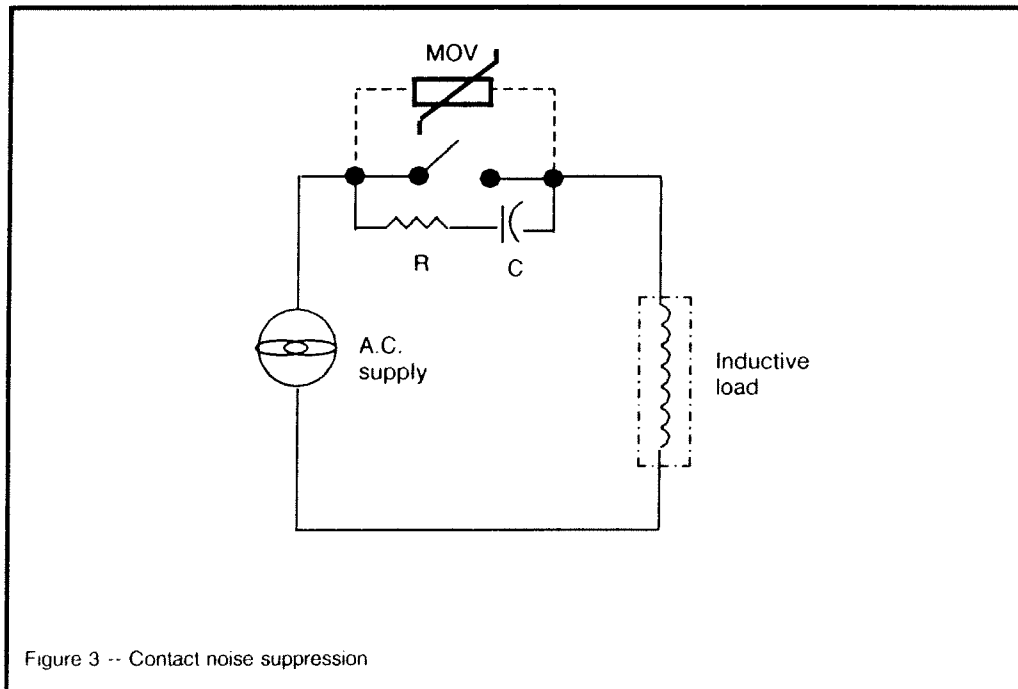

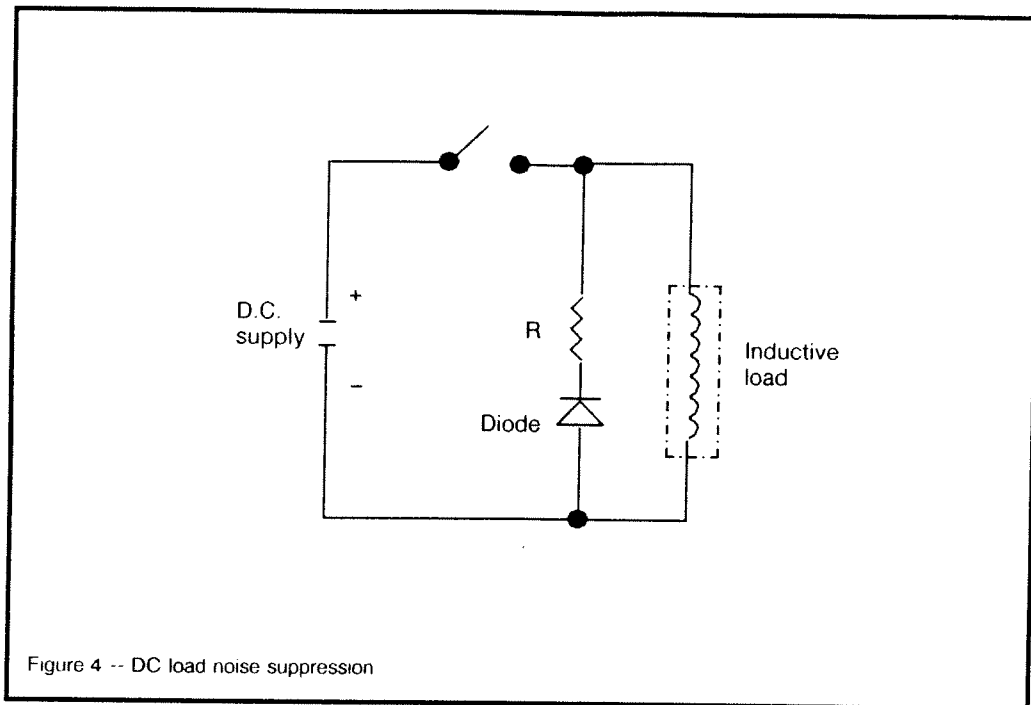

Figure 4 -- DC load noise suppression

4 Configuring Your Recorder

Summary

This section assumes that you have decoded your recorder's model number, the recorder has been installed and wired accordingly, and the Configuration Worksheet (at the end of this section) is completely filled in.

You must define what application specific functions you want the DR 4500 recorder to perform as well as specify relevant operational parameters through software Configuration. In software configuration, you enter the parameter values and selections into memory that match your process recording/controlling requirements.

The recorder includes a configuration program with sequenced English language prompts that appear in the upper and lower displays of the operator interface (see Display and Key Pad Descriptions). This makes it easy to enter data using only a few straightforward sequences.

Configuration Prompt Hierarchy

The configuration Prompt Hierarchy identifies all the Group prompts that may appear in a given DR 4500 recorder model. But, not all the prompts are applicable for every recorder model so refer to your Configuration Worksheet for your specific application prompts.

We recommend that you fill out the configuration worksheet first, and then, select prompts and enter configuration data in the following order.

<u>Step</u>	<u>Prompt</u>	<u>Page Ref.</u>
1.	CHART	4-31
2.	TIME	4-35
3.	OPTIONS	4-70
4.	PEN	4-41
5.	INPUT	4-46
6.	CONTROL	4-57
7.	TOTAL	4-53
8.	ALARMS	4-78
9.	TUNING	4-11
10.	SP RAMP	4-16
11.	LOCKOUT	4-87



Figure 4-1 -- PROMPT HIERARCHY

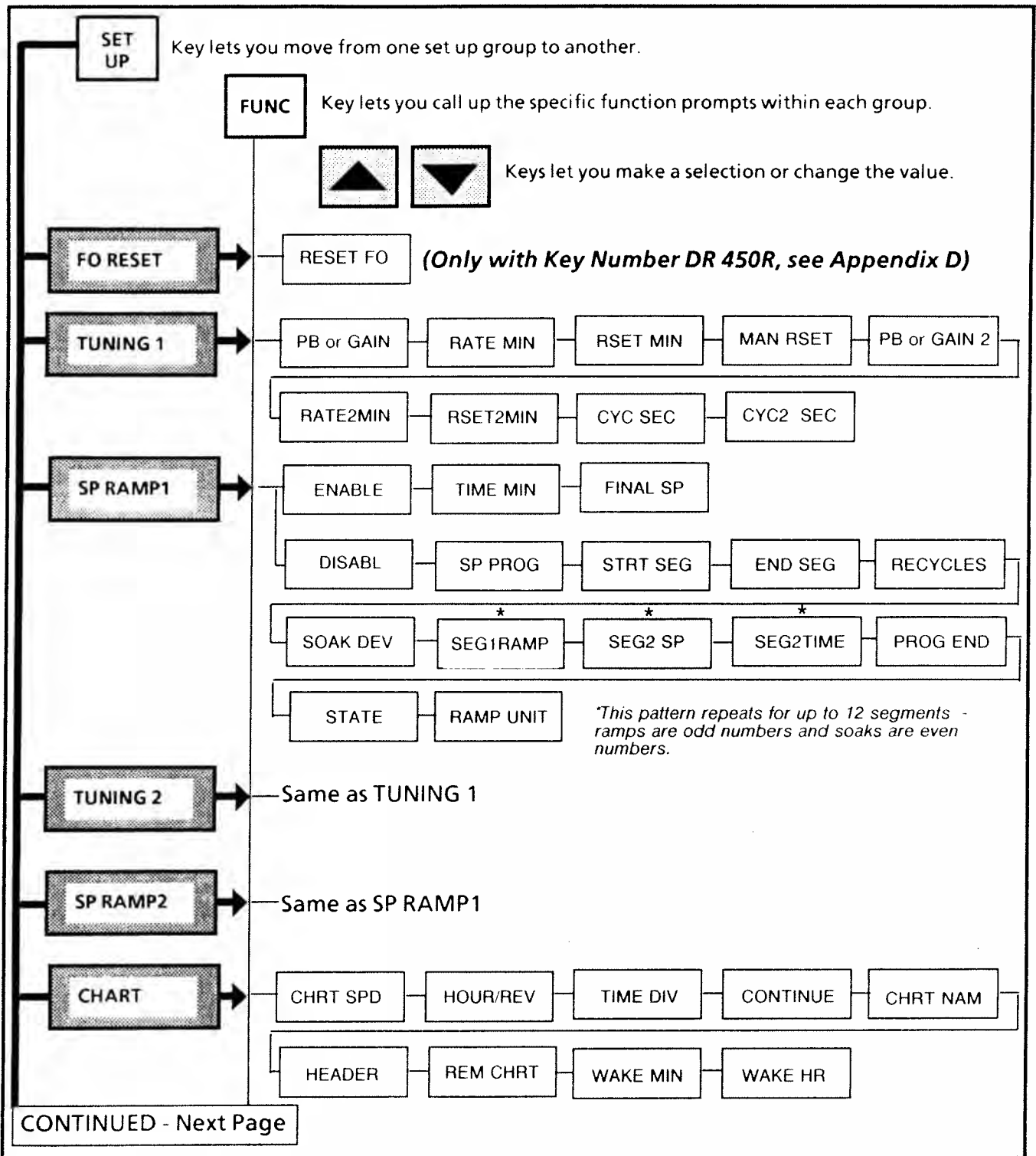

Figure 4-1 -- PROMPT HIERARCHY -- Continued

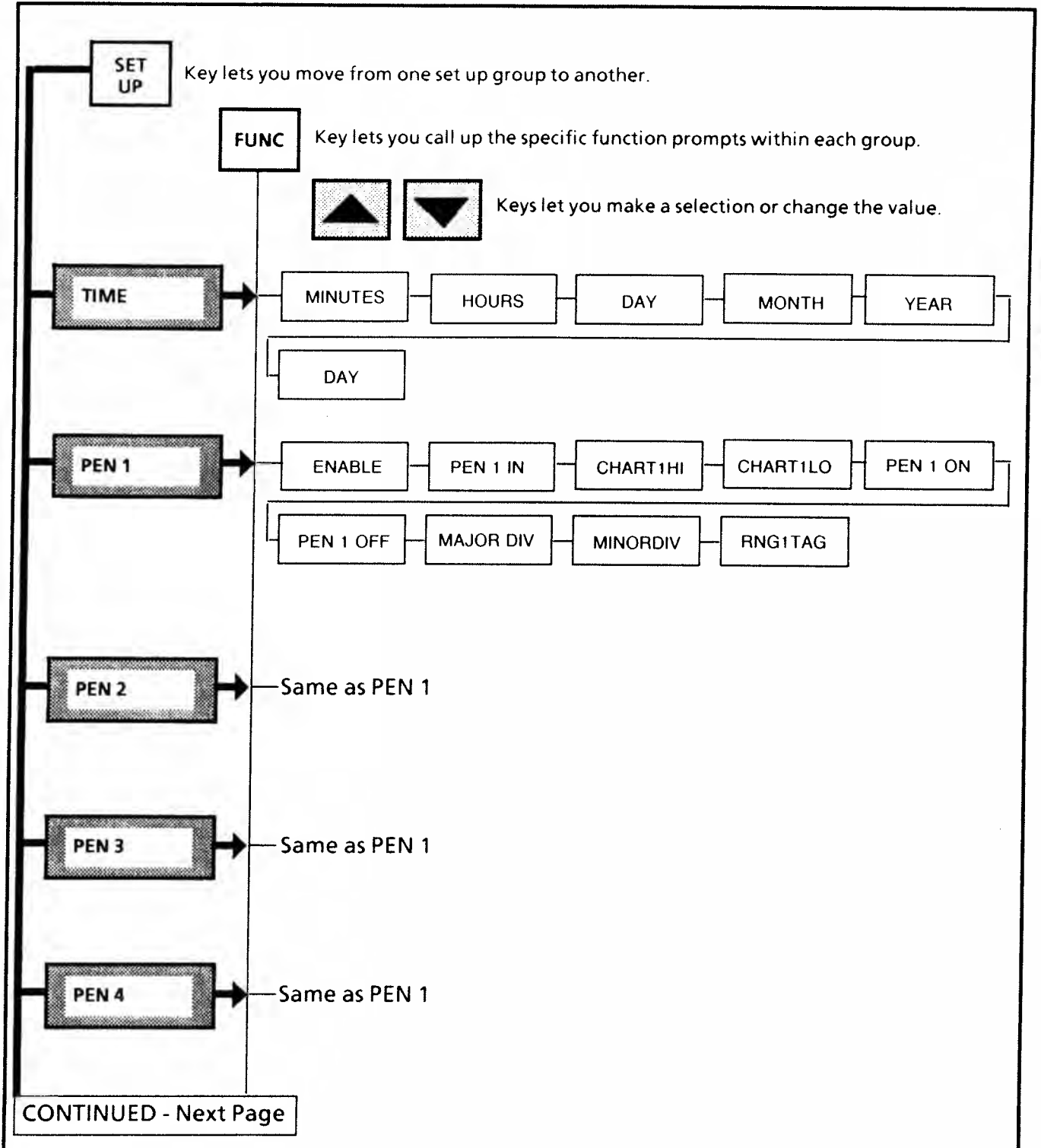

Figure 4-1 -- PROMPT HIERARCHY -- Continue

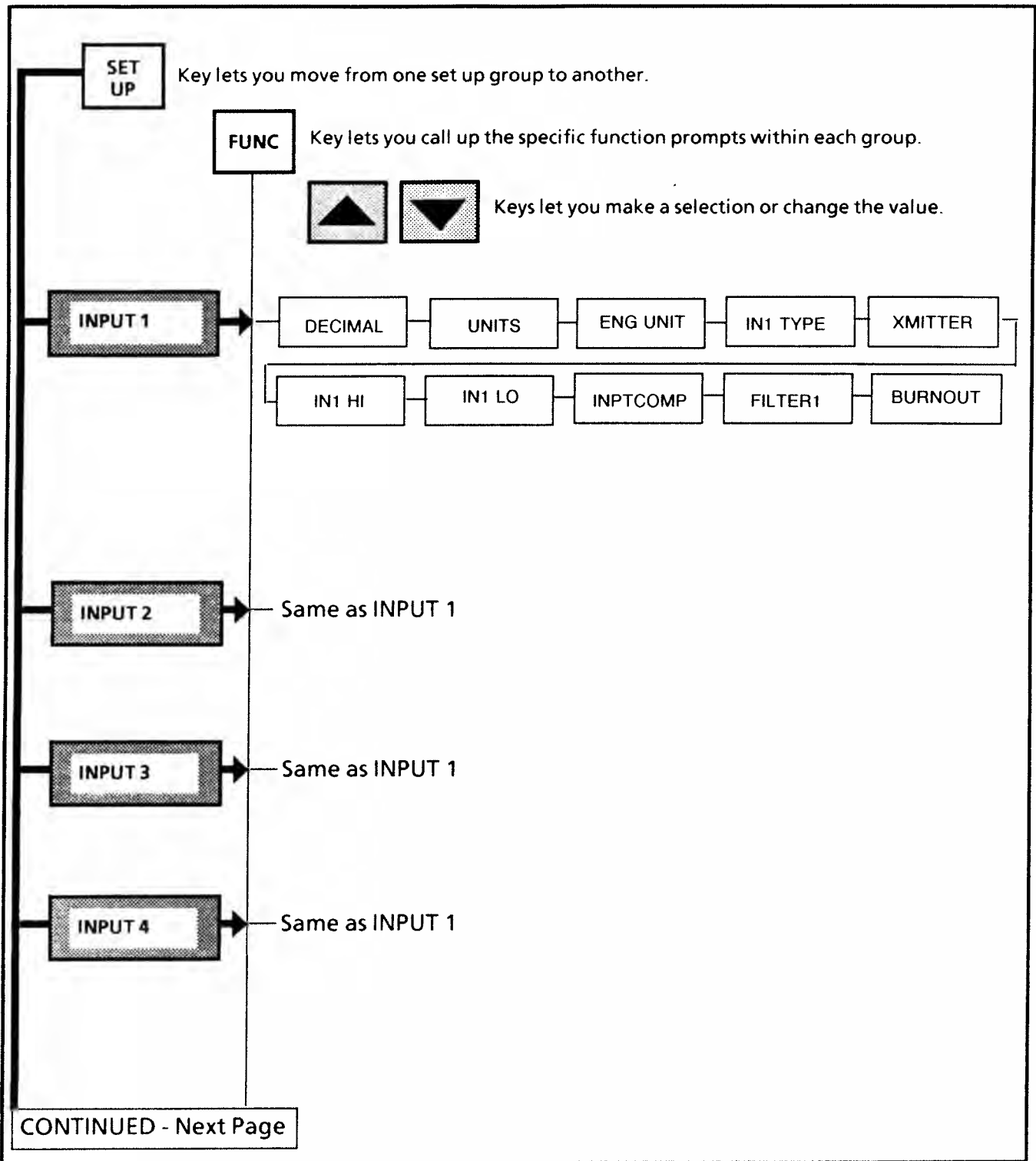
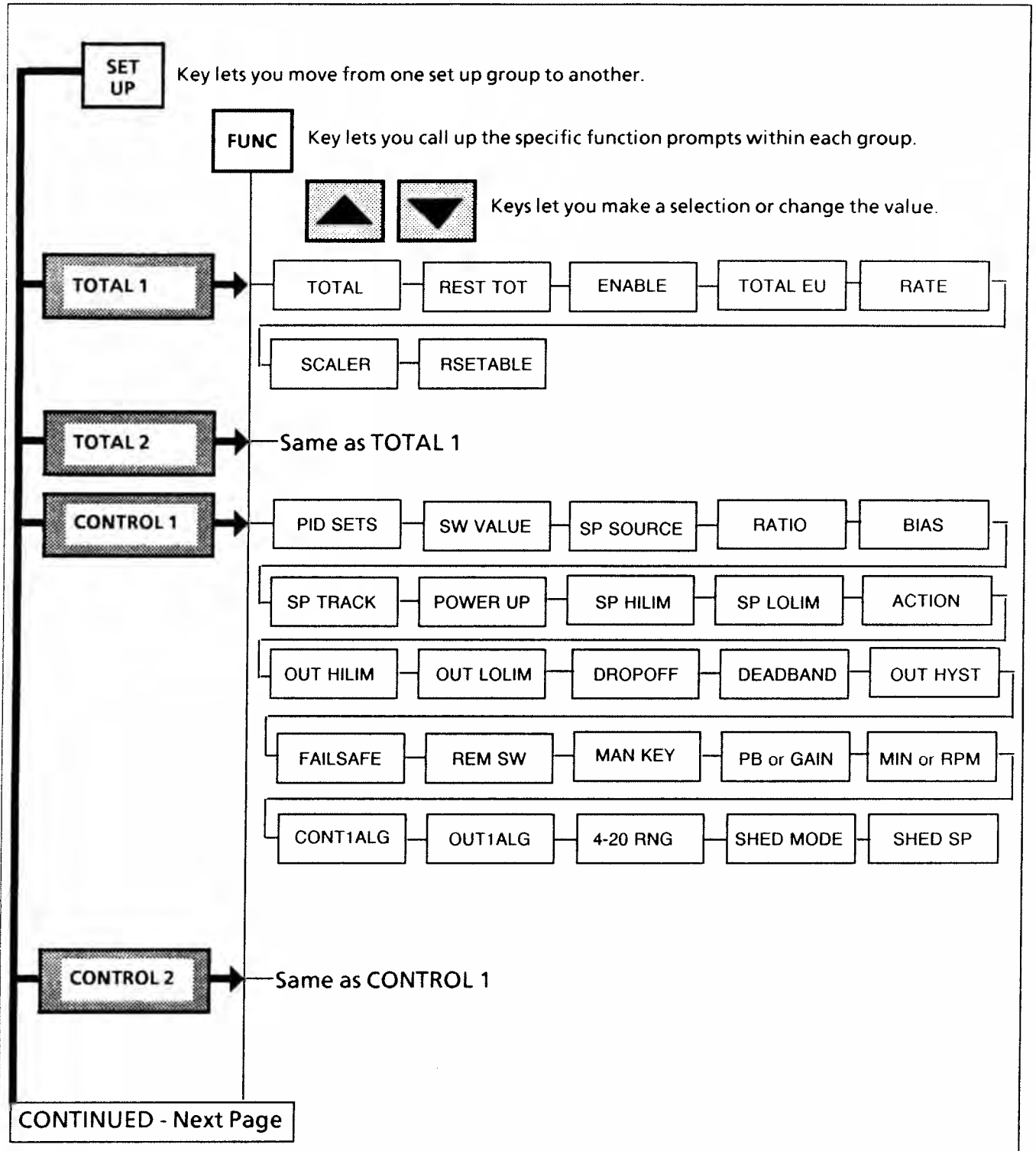
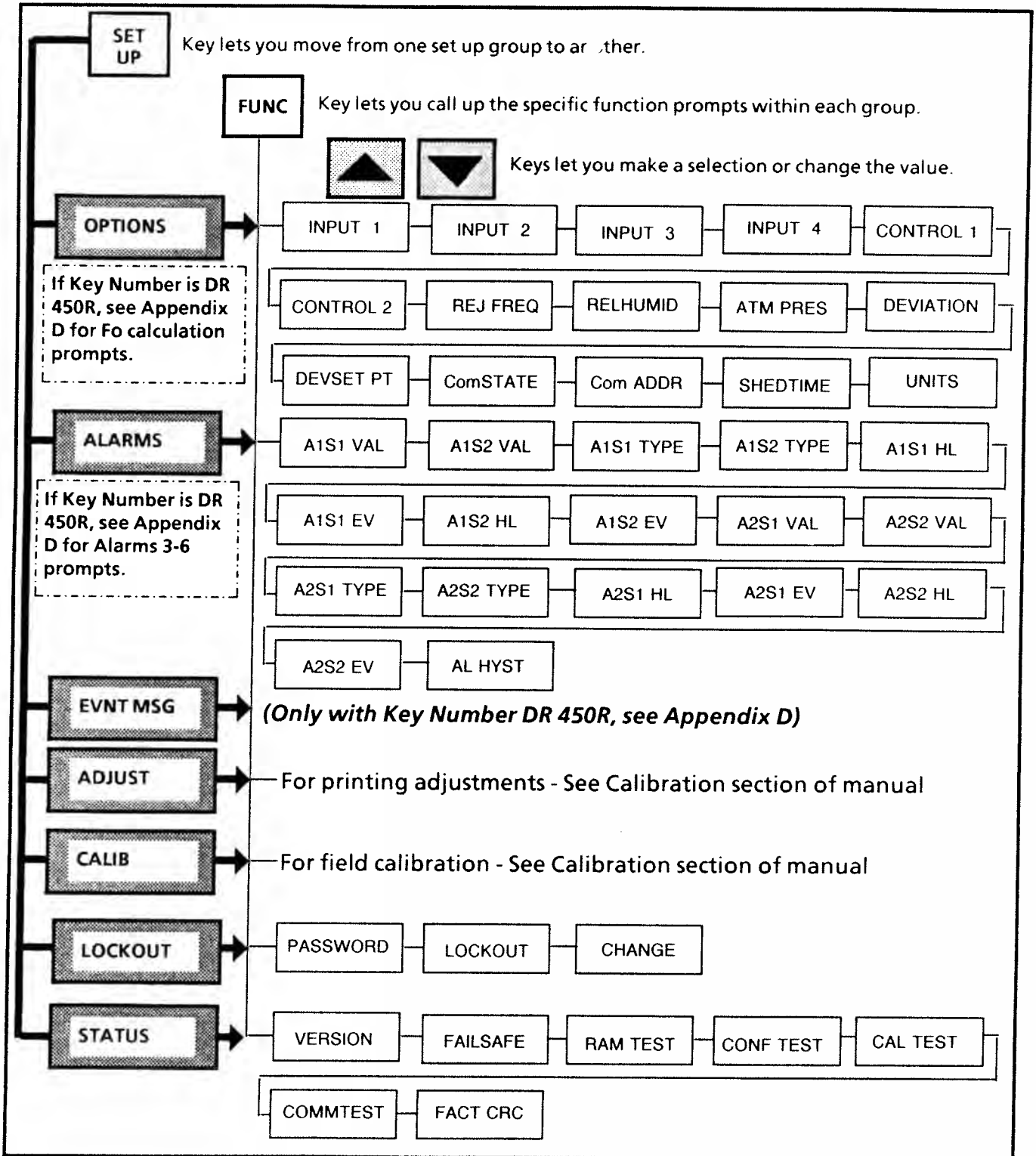

Figure 4-1 -- PROMPT HIERARCHY -- Continued



4

Figure 4-1 -- PROMPT HIERARCHY -- Continued



4 Configuring Your Recorder – Continued

A. Power Up

Apply power and watch the displays for these sequential indications as the recorder runs its self diagnostic tests:



4. All indicators and display segments light for a few seconds.



6. Recorder goes into operating mode.

7. If a FAILED indication was given instead of PASSED, a display segment didn't light, or a prompt message is blinking in the lower display, see the Service section in this manual for Troubleshooting data.

4 Configuring Your Recorder – Continued

A-1. Run Key Test (Optional)

You can run this key test to verify key operation or just become more familiar with key and display action.

1. Open recorder door and press [SET UP] AND [FUNC] keys together. Release keys and observe these indications:
 - (a) All indicators and display segments light.

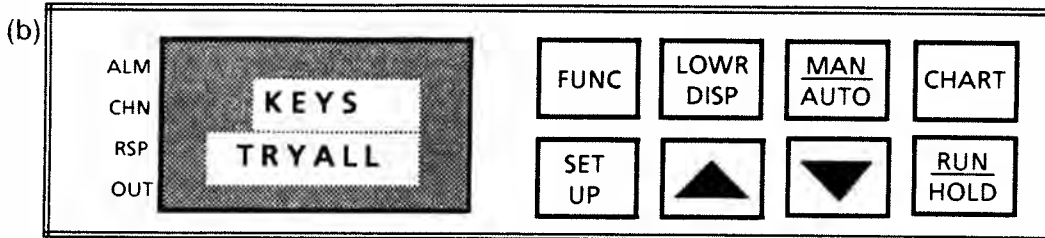

2. Press each key in turn and look for the corresponding key name to appear in the lower display. Note that recorder automatically exits the key test if no key is pressed within 25 seconds.

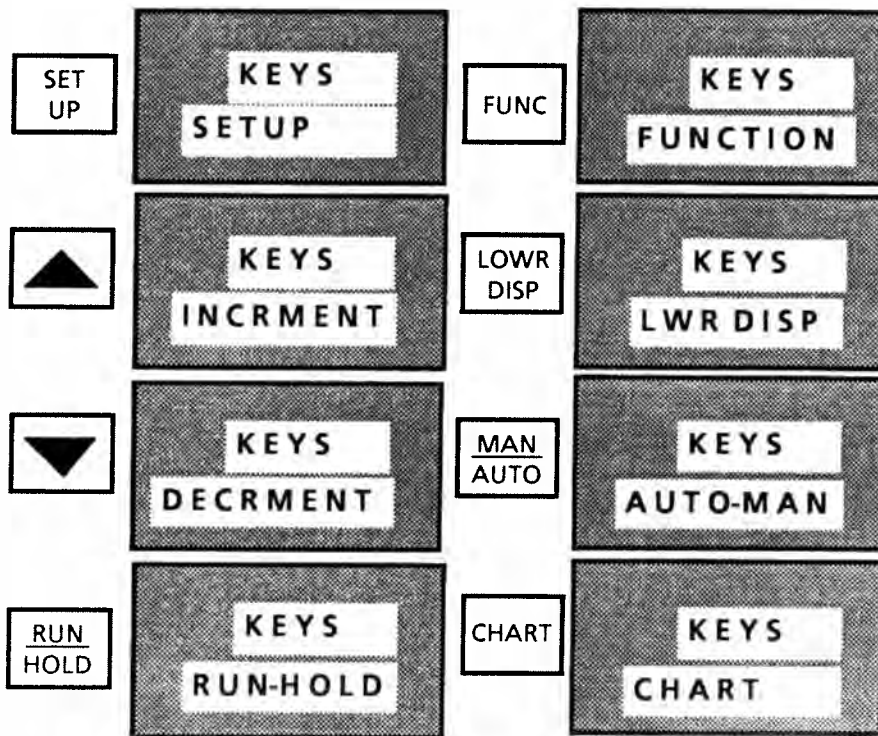

4 Configuring Your Recorder -- Continued

A-1. Run Key Test (Optional) -- Continued

3. If a key name didn't appear, the key is defective -- See Service section for details.
4. Let the key test time out automatically.

A-2. Display and Key Pad Descriptions

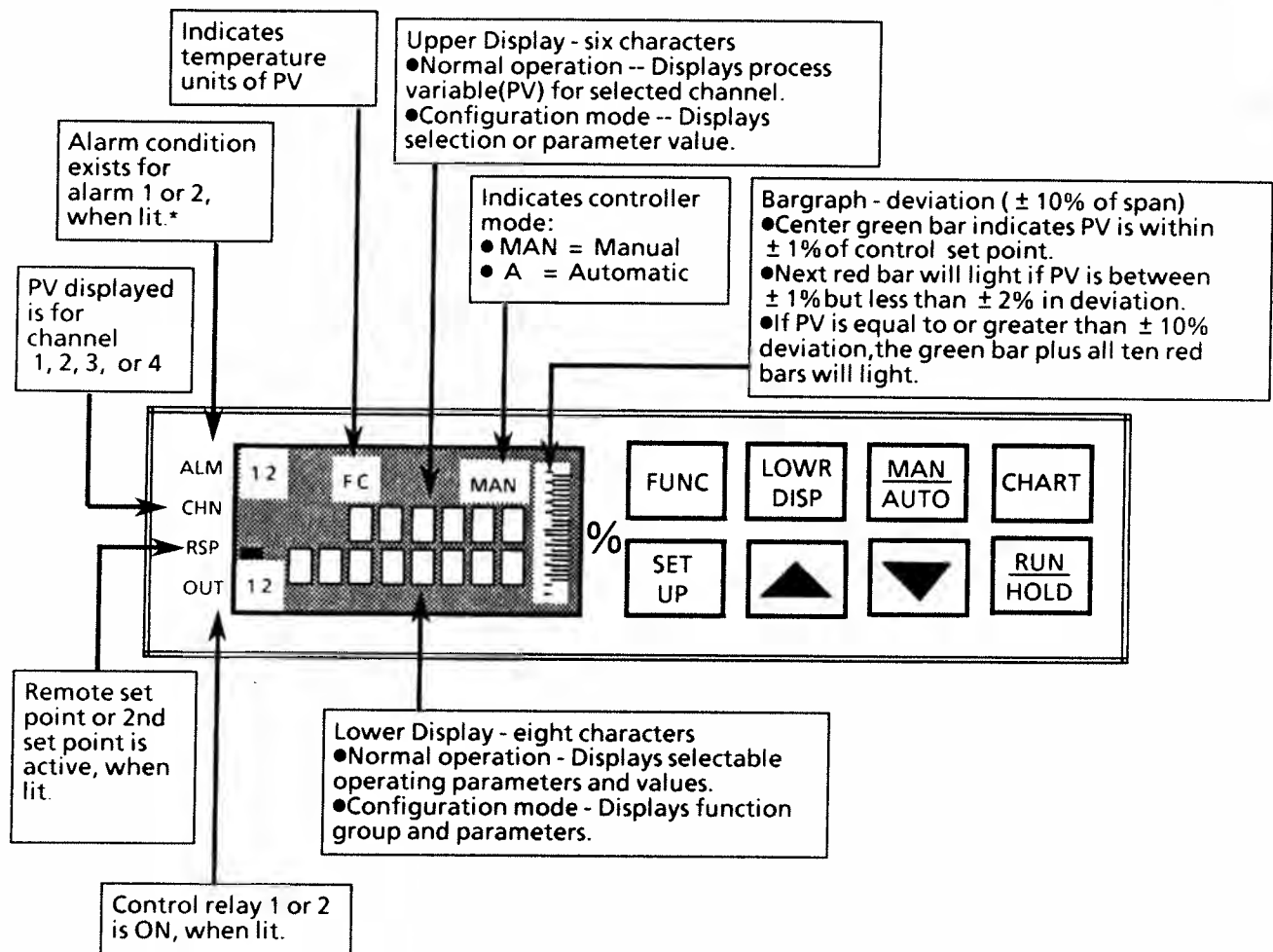

*There is no indication provided for alarms 3, 4, 5 and 6.

4 Configuring Your Recorder -- Continued

A-2. Display and Key Pad Descriptions -- Continued

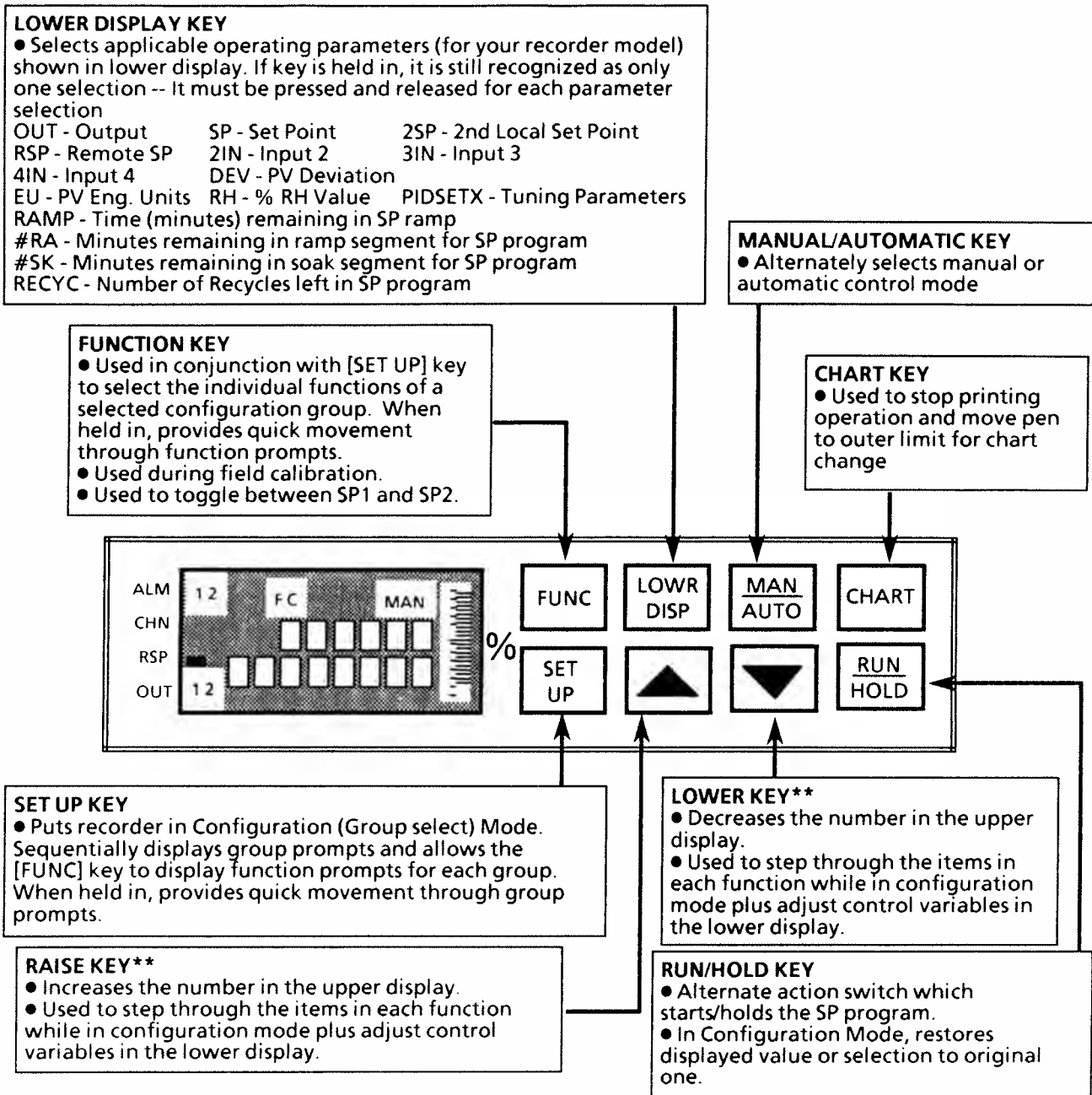

**To change a value more quickly, hold in one key and press the other. Adjustment moves one digit to the left with each press.

4 Configuring Your Recorder – Continued

B. TUNING 1 and TUNING 2 Configuration

Prerequisites:

- Table II = 1X or 4X/11, 14, 41, or 44 per Model Number.
- Recorder door is open and power is ON.
- See Appendix A for detailed explanation of function prompts associated with “control.”
- Keypad LOCKOUT configuration is NONE.

1. Press [SET UP] key to put recorder in Configuration (SET UP) Mode and call up TUNING 1 (or TUNING 2) prompt in lower display. If recorder is in SET UP Mode, successively press [SET UP] key to step through group prompts or hold key in to scroll prompts until TUNING 1 (or TUNING 2) appears in display.

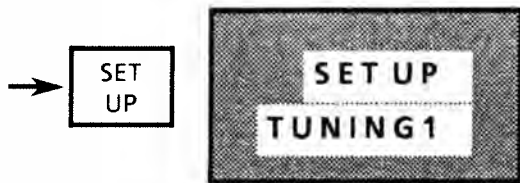

REMARKS
 If you want to abort (exit) configuration, press [LOWR DISP] key or don't press any key for 1 minute.

2. Press [FUNC] key to call up first tuning parameter for configuration.

NOTE: Hold key in if you want to scroll through all the function prompts associated with this group.

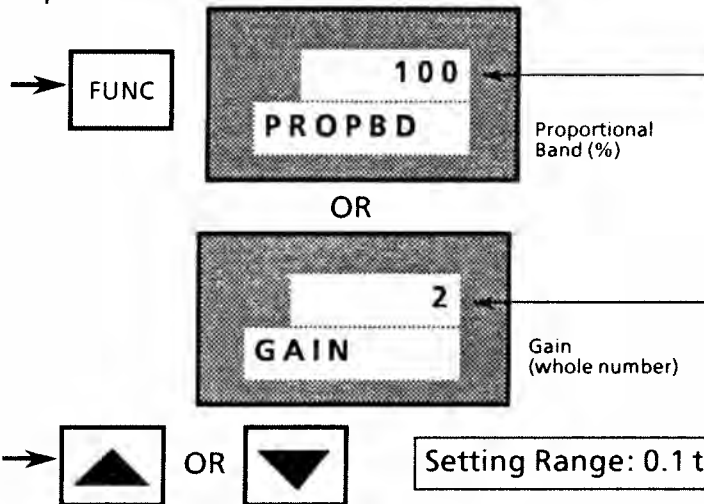

REMARKS
 See function prompt PB or GAIN in CONTROL 1 group to select prompt (PROP BD) or (GAIN) to appear here.

3. Use [RAISE] or [LOWER] key to set desired value in upper display or go to Step 4.

NOTE: If display blinks, you are trying to select an unacceptable value. You can change value more quickly by holding in one key [RAISE] or [LOWER] and pressing other one [LOWER] or [RAISE] at same time. Adjustment will move one digit to the left with each press.

4 Configuring Your Recorder – Continued

B. TUNING 1 and TUNING 2 Configuration -- Continued

NOTE: To recall original value or selection, press [RUN/HOLD] key before pressing [FUNC] key again.

4. Press [FUNC] key to call up next parameter and enter present selection.

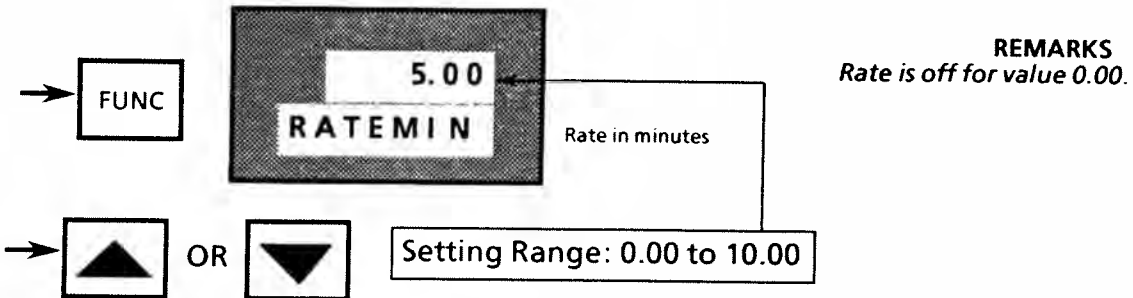

5. Use [RAISE] or [LOWER] key to set desired value in upper display or go to Step 6.

6. Press [FUNC] key to call up next parameter and enter present selection.

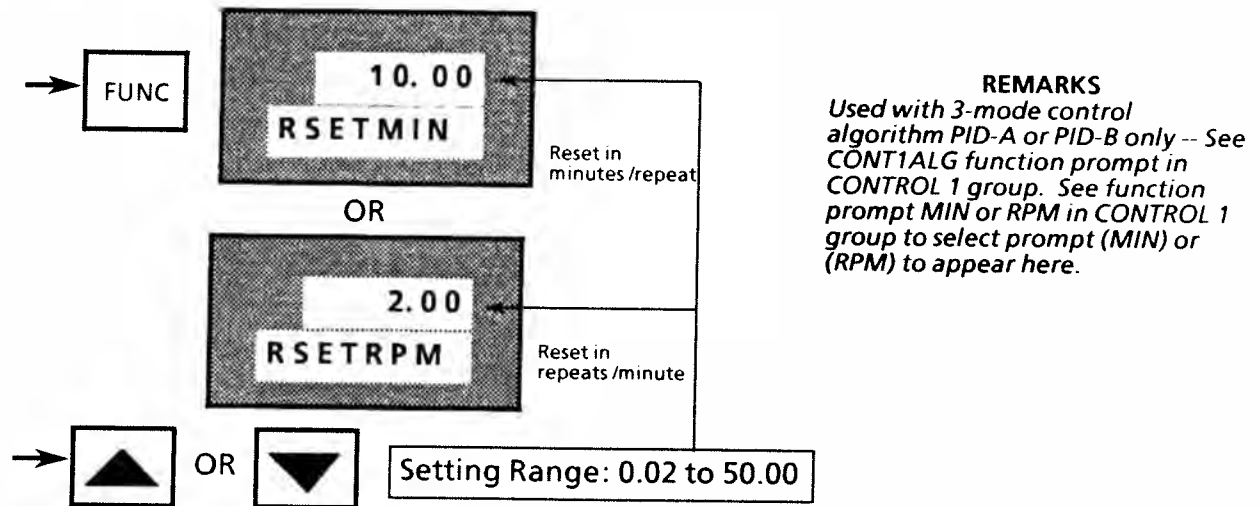

7. Use [RAISE] or [LOWER] key to set desired value in upper display or go to Step 8.

4 Configuring Your Recorder – Continued

B. TUNING 1 and TUNING 2 Configuration -- Continued

Not applicable for model DR450R recorders

8. Press [FUNC] key to call up next parameter and enter present selection.

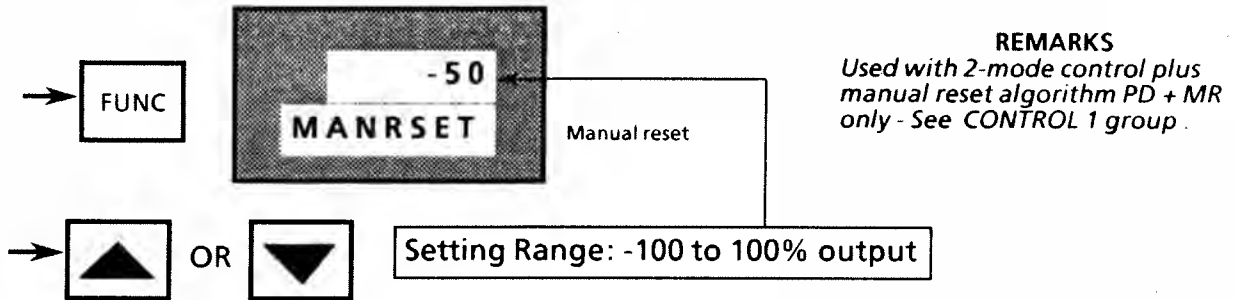

9. Use [RAISE] or [LOWER] key to set desired value in upper display or go to Step 10.

10. Press [FUNC] key to call up next parameter and enter present selection.

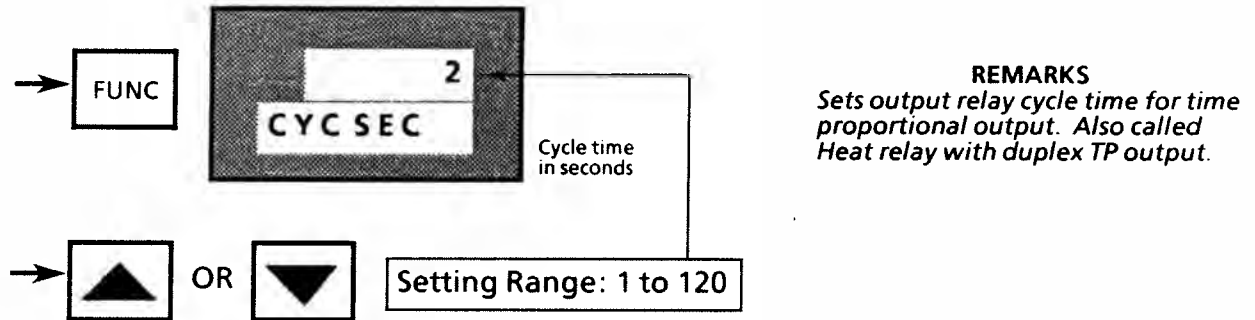

11. Use [RAISE] or [LOWER] key to set desired value in upper display or go to Step 12.

4 Configuring Your Recorder – Continued

B. TUNING 1 and TUNING 2 Configuration -- Continued

12. Press [FUNC] key to call up next parameter and enter present selection.

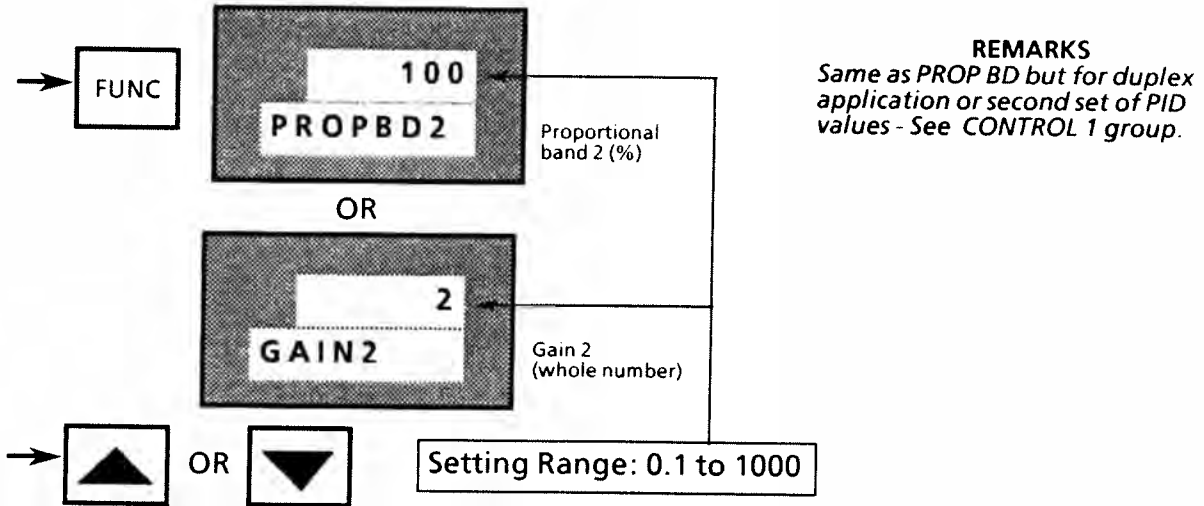

13. Use [RAISE] or [LOWER] key to set desired value in upper display or go to Step 14.

14. Press [FUNC] key to call up next parameter and enter present selection.

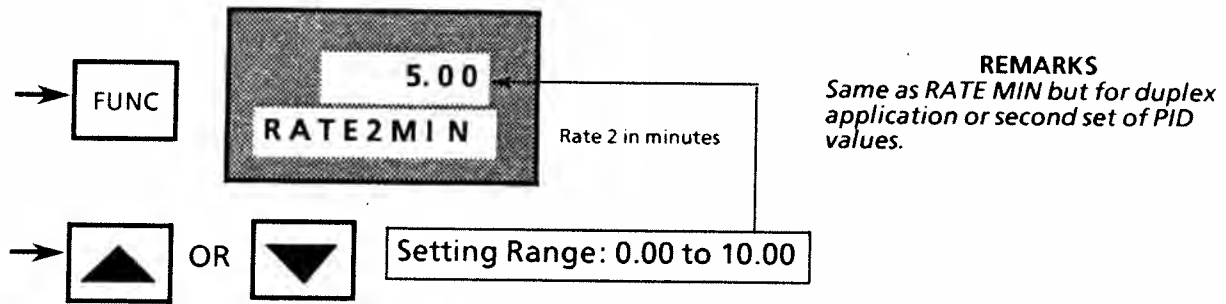

15. Use [RAISE] or [LOWER] key to set desired value in upper display or go to Step 16.

4 Configuring Your Recorder – Continued

B. TUNING 1 and TUNING 2 Configuration -- Continued

16. Press [FUNC] key to call up next parameter and enter present selection.

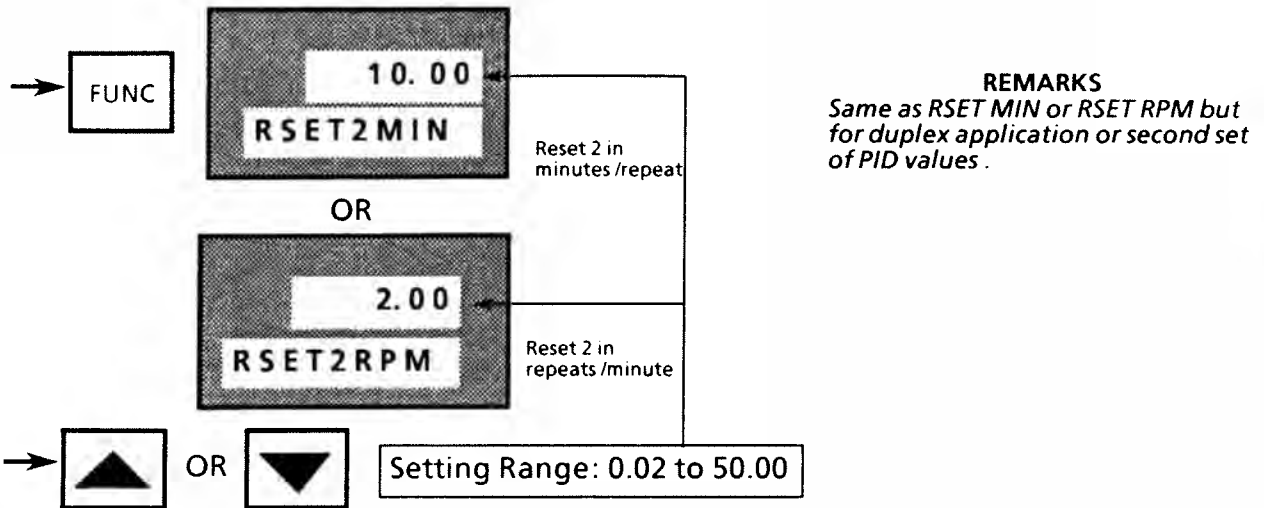

17. Use [RAISE] or [LOWER] key to set desired value in upper display or go to Step 18.

18. Press [FUNC] key to call up next parameter and enter present selection.

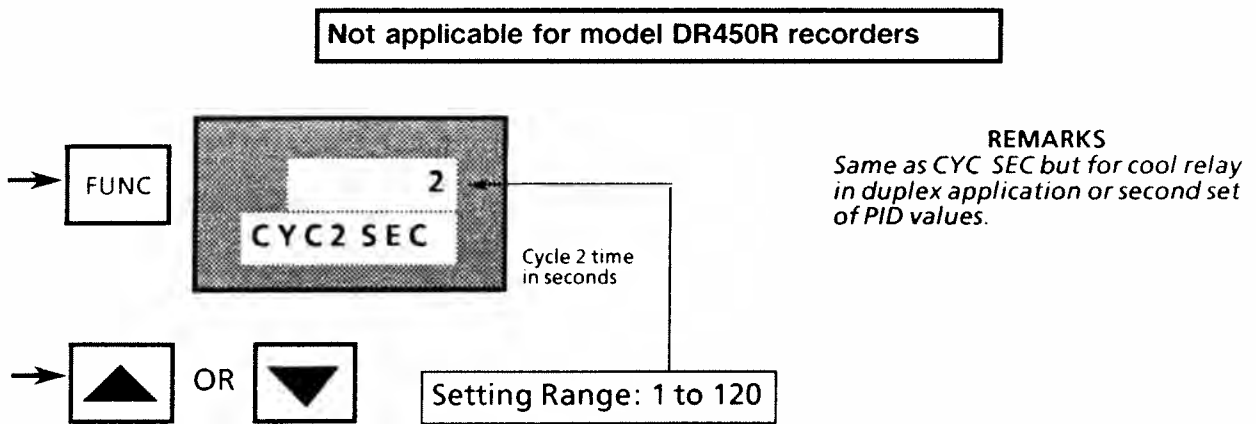

19. Press [SET UP] key to call up next group prompt and go to appropriate procedure in this section. Or, press [LOWR DISP] key to exit configuration mode.

REPEAT PROCEDURE FOR TUNING 2 CONFIGURATION

4 Configuring Your Recorder – Continued

C. SP RAMP1 and SP RAMP2 Configuration

Prerequisites:

- Table II = 1X or 4X/11, 14, 41, or 44 per Model Number
- Recorder door is open and power is ON.
- See Appendix C for more information about set point ramp/soak program, if Table II = 4X or X4.
- Keypad LOCKOUT configuration is NONE.

1. Press [SET UP] key to put recorder in Configuration (SET UP) Mode and call up SP RAMP1 (or SP RAMP2) prompt in lower display. If recorder is in SET UP Mode, successively press [SET UP] key to step through group prompts or hold key in to scroll prompts until SP RAMP1 (or SP RAMP2) appears in display.



REMARKS
 If you want to abort (exit) configuration, press [LOWR DISP] key or don't press any key for 1 minute.

2. Press [FUNC] key to call up first parameter for configuration.

NOTE: Hold key in if you want to scroll through all the function prompts associated with this group.

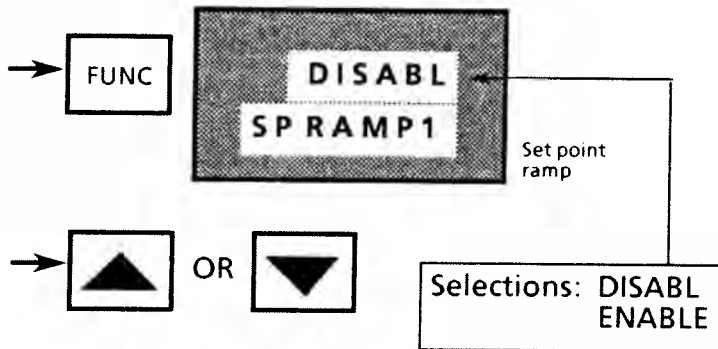

3. Use [RAISE] or [LOWER] key to select prompt to “enable” or “disable” single Set Point Ramp function.

- If you select ENABLE, go to Step 4.
- If you select DISABL - And Table II = 1X, go to Step 7.
 - And Table II = 4X, go to Step 8.

NOTE: To recall original value or selection, press [RUN/HOLD] key before pressing [FUNC] key again.

4 Configuring Your Recorder -- Continued

C. SP RAMP1 and SP RAMP2 Configuration -- Continued

4. Press [FUNC] key to call up next parameter and enter present selection.

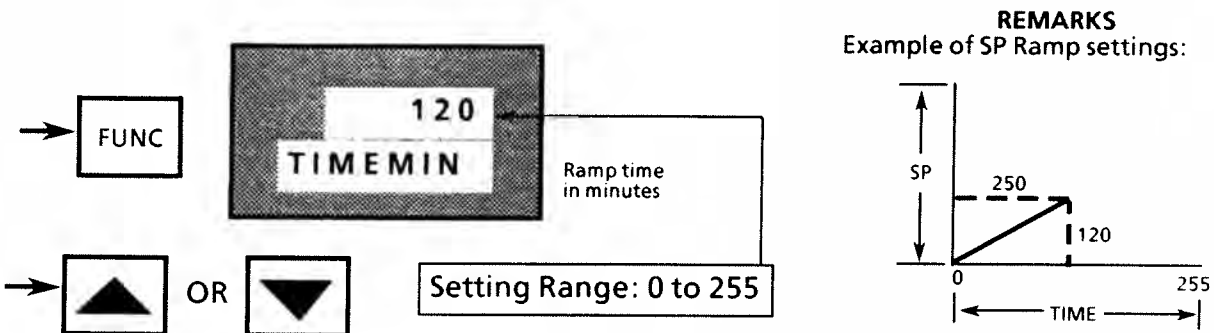

5. Use [RAISE] or [LOWER] key to set desired time for SP ramp in upper display or go to Step 6.

NOTE: If display blinks, you are trying to select an unacceptable value. You can change value more quickly by holding in one key [RAISE] or [LOWER] and pressing other one [LOWER] or [RAISE] at same time. Adjustment will move one digit to the left with each press.

6. Press [FUNC] key to call up next parameter and enter present selection.

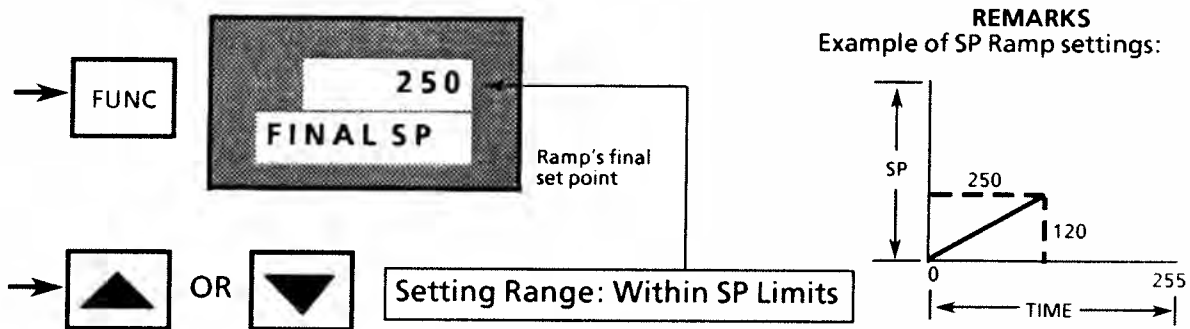

7. Press [SET UP] key to call up next group prompt and go to appropriate procedure in this section. Or, press [LOWR DISP] key to exit Configuration Mode.

REPEAT PROCEDURE FOR SP RAMP2 CONFIGURATION.

4 Configuring Your Recorder -- Continued

C. SP RAMP (PROGRAM) 1 Configuration

8. Press [FUNC] key to call up next parameter and enter present selection.

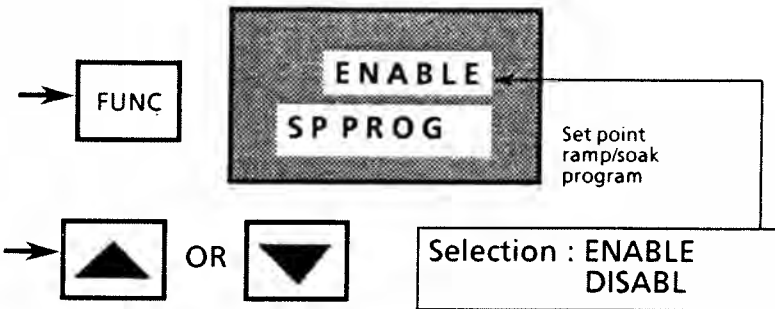

REMARKS
Table II = 4X and SP RAMP1 is "disabled."

9. Use [RAISE] or [LOWER] key to select prompt to enable or disable SP program:
- If you select ENABLE, go to Step 10
 - If you select DISABL, go to Step 60

10. Press [FUNC] key to call up next parameter and enter present selection.

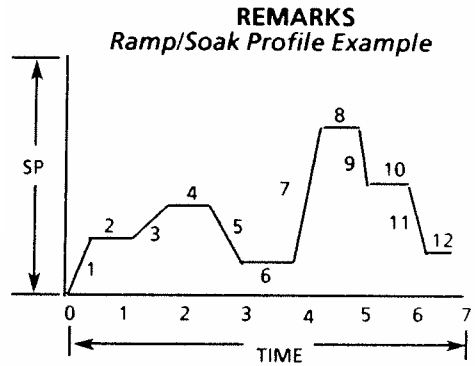
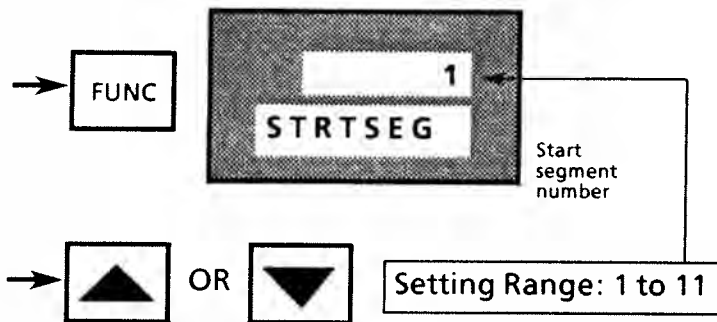

11. Use [RAISE] or [LOWER] key to set desired segment number in upper display or go to Step 12.

4 Configuring Your Recorder -- Continued

C. SP RAMP (PROGRAM) 1 Configuration -- Continued

12. Press [FUNC] key to call up next parameter and enter present selection.

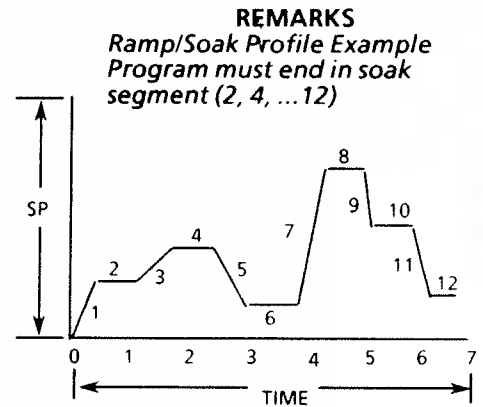
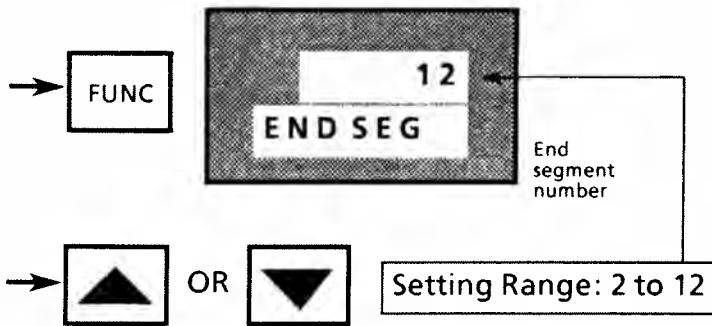

4

13. Use [RAISE] or [LOWER] key to set desired segment number in upper display or go to Step 14.

14. Press [FUNC] key to call up next parameter and enter present selection.

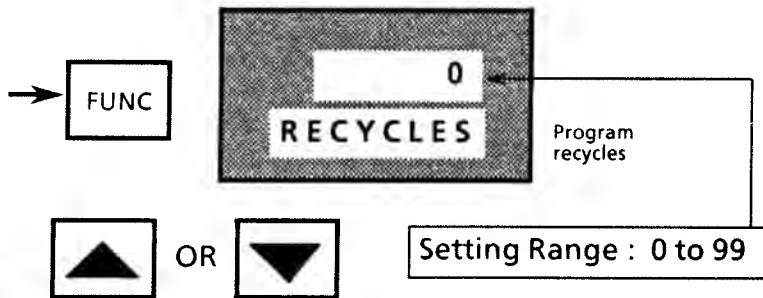

15. Use [RAISE] or [LOWER] key to set number of times program is to recycle in upper display or go to Step 16.

4 Configuring Your Recorder -- Continued

C. SP RAMP (PROGRAM) 1 Configuration -- Continued

16. Press [FUNC] key to call up next parameter and enter present selection.

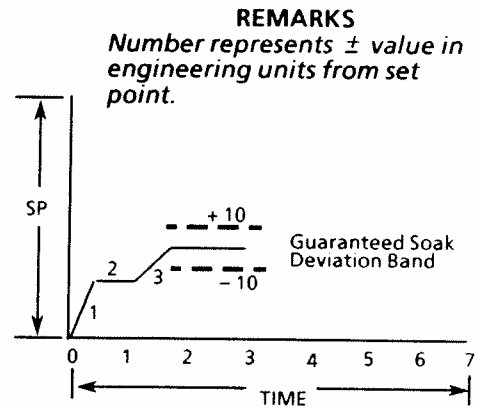
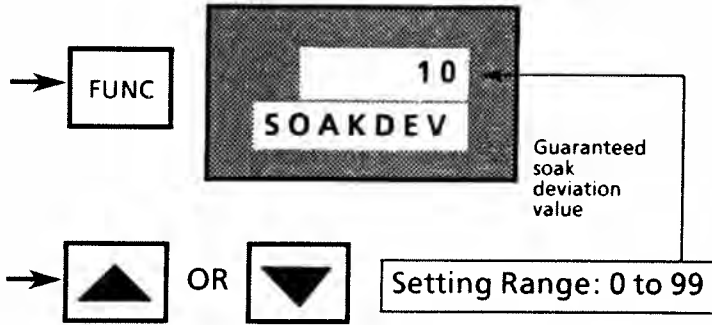

17. Use [RAISE] or [LOWER] key to set desired value in upper display or go to Step 18.

18. Press [FUNC] key to call up next parameter and enter present selection.

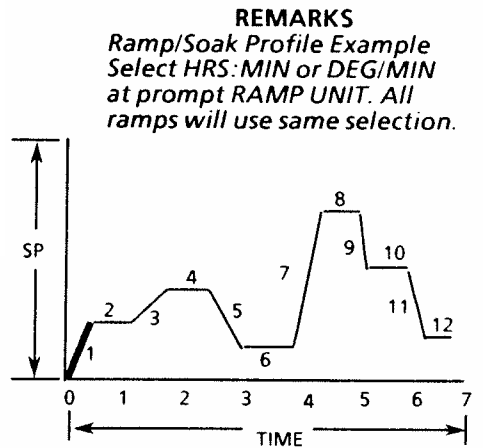
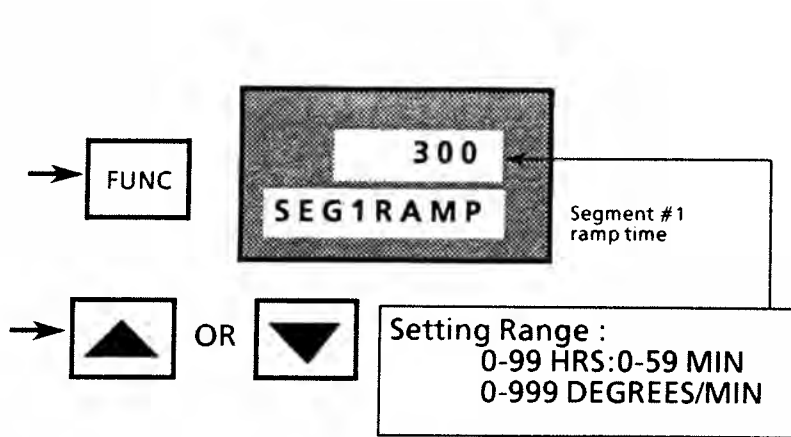

19. Use [RAISE] or [LOWER] key to set desired value in upper display or go to Step 20.

4 Configuring Your Recorder – Continued

C. SP RAMP (PROGRAM) 1 Configuration -- Continued

20. Press [FUNC] key to call up next parameter and enter present selection.

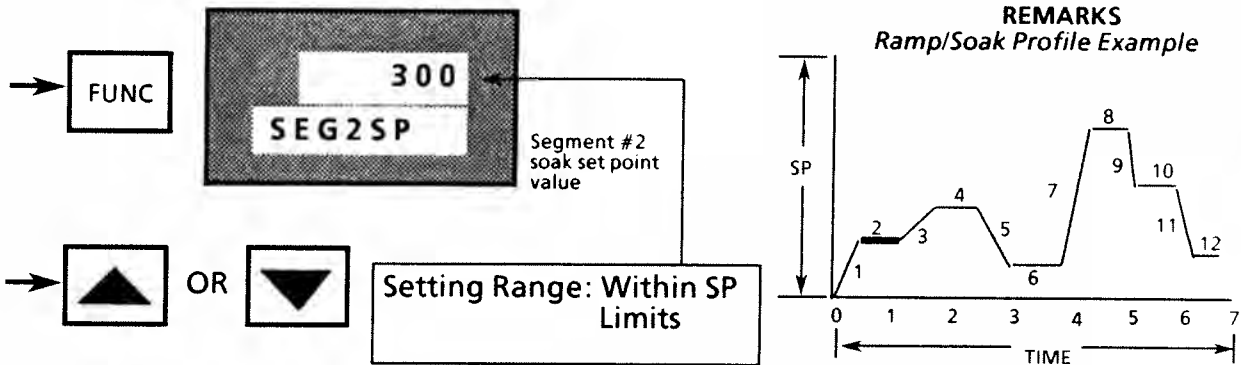

21. Use [RAISE] or [LOWER] key to set desired value in upper display or go to Step 22.

22. Press [FUNC] key to call up next parameter and enter present selection.

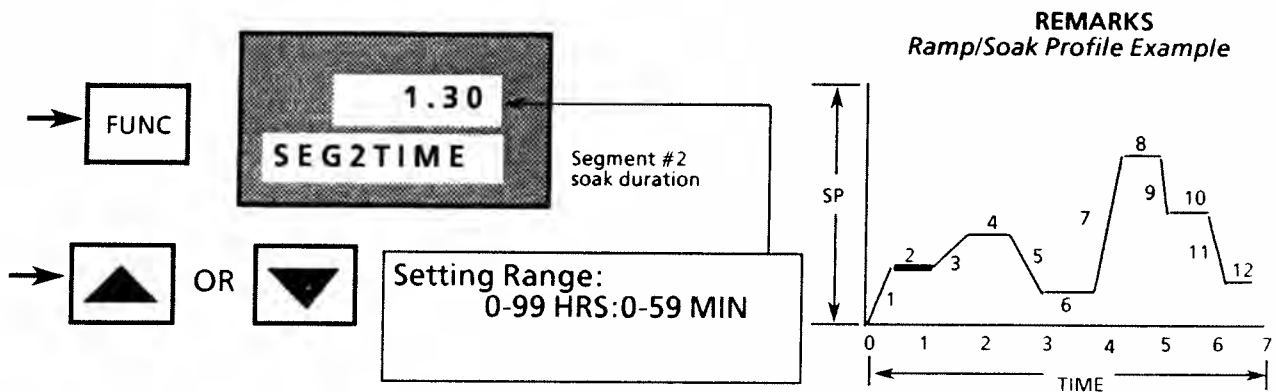

23. Use [RAISE] or [LOWER] key to set desired value in upper display or go to Step 24.

4 Configuring Your Recorder -- Continued

C. SP RAMP (PROGRAM) 1 Configuration -- Continued

24. Press [FUNC] key to call up next parameter and enter present selection.

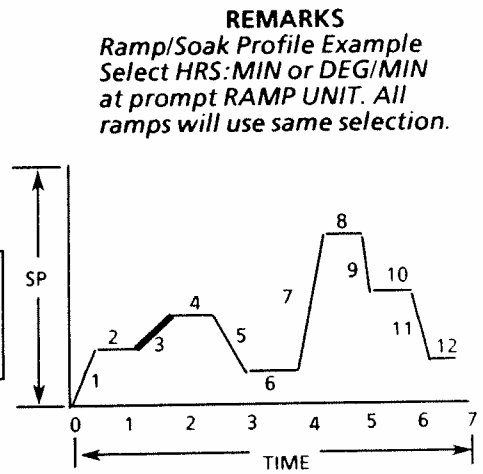
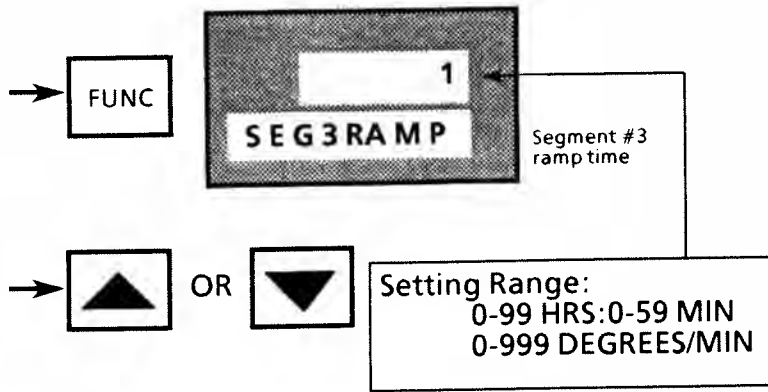

25. Use [RAISE] or [LOWER] key to set desired value in upper display or go to Step 26.

26. Press [FUNC] key to call up next parameter and enter present selection.

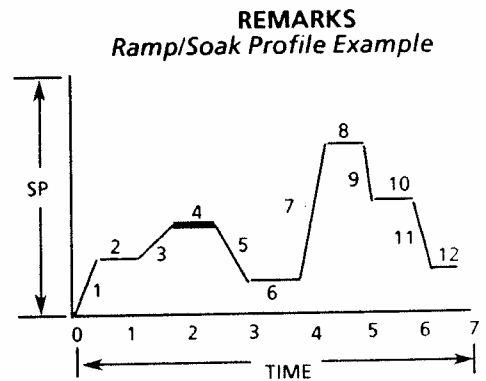
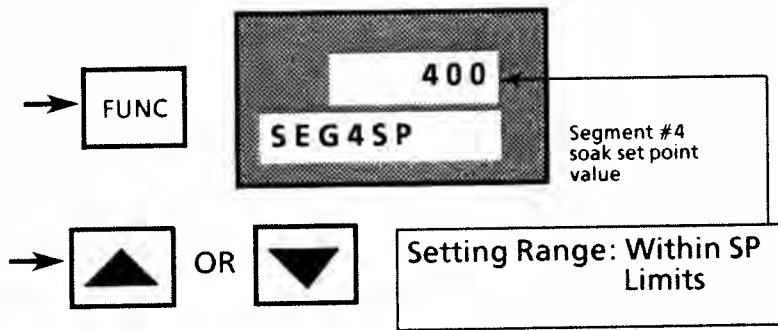

27. Use [RAISE] or [LOWER] key to set desired value in upper display or go to Step 28.

4 Configuring Your Recorder – Continued

C. SP RAMP (PROGRAM) 1 Configuration -- Continued

28. Press [FUNC] key to call up next parameter and enter present selection.

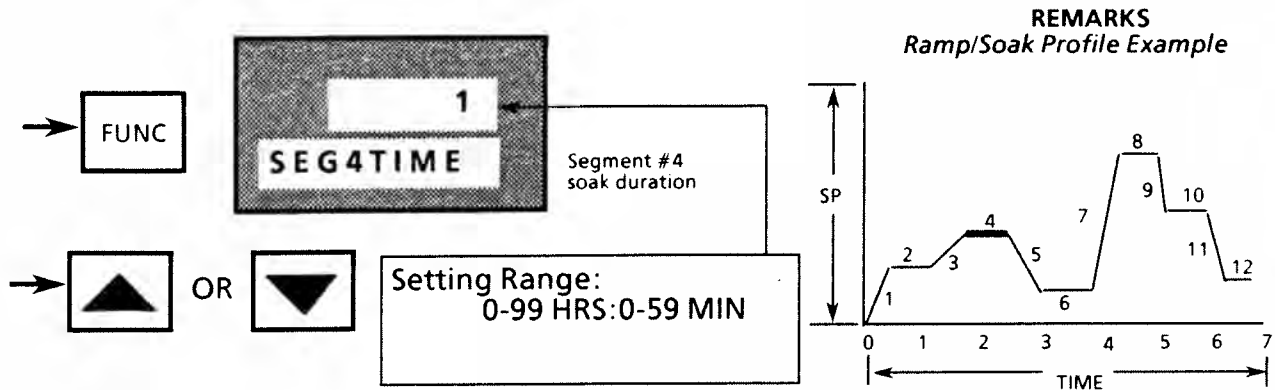

29. Use [RAISE] or [LOWER] key to set desired value in upper display or go to Step 30.

30. Press [FUNC] key to call up next parameter and enter present selection.

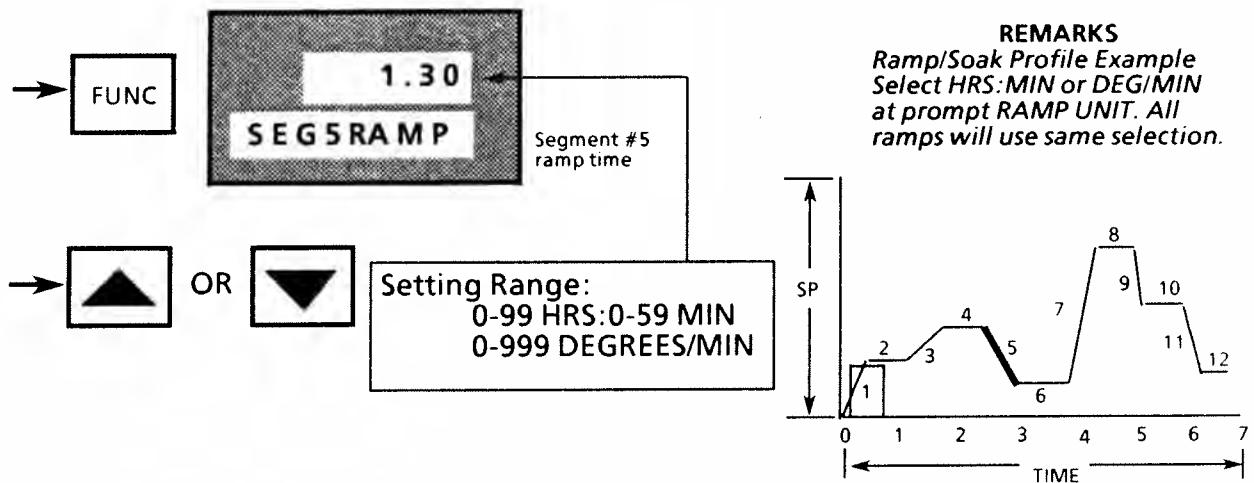

31. Use [RAISE] or [LOWER] key to set desired value in upper display or go to Step 32.

4 Configuring Your Recorder -- Continued

C. SP RAMP (PROGRAM) 1 Configuration -- Continued

32. Press [FUNC] key to call up next parameter and enter present selection.

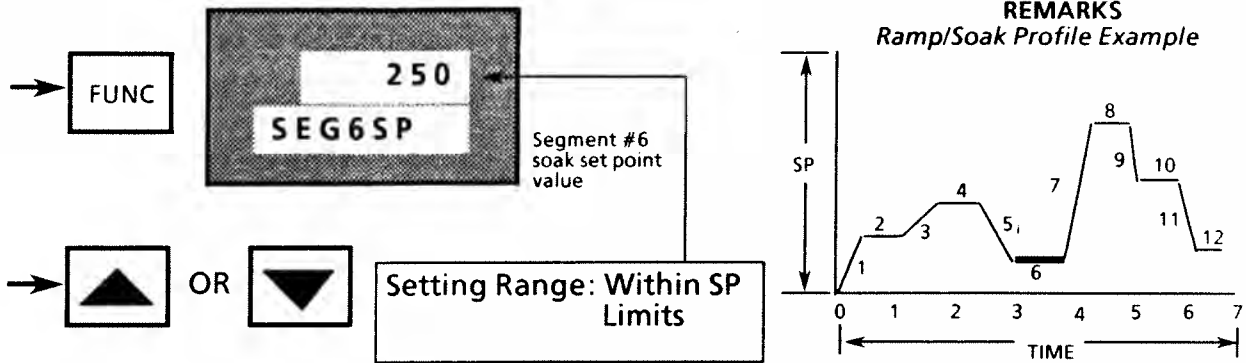

33. Use [RAISE] or [LOWER] key to set desired value in upper display or go to Step 34.

34. Press [FUNC] key to call up next parameter and enter present selection.

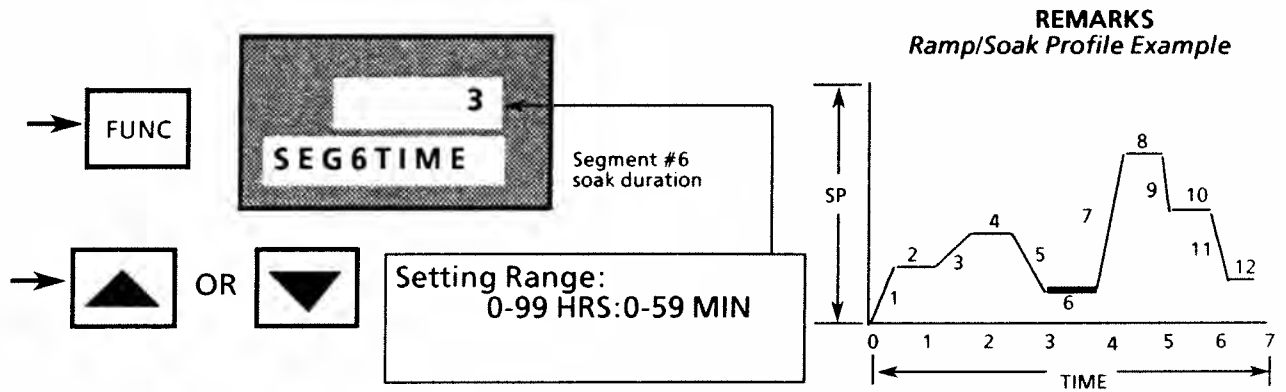

35. Use [RAISE] or [LOWER] key to set desired value in upper display or go to Step 36.

4 Configuring Your Recorder – Continued

C. SP RAMP (PROGRAM) 1 Configuration -- Continued

36. Press [FUNC] key to call up next parameter and enter present selection.

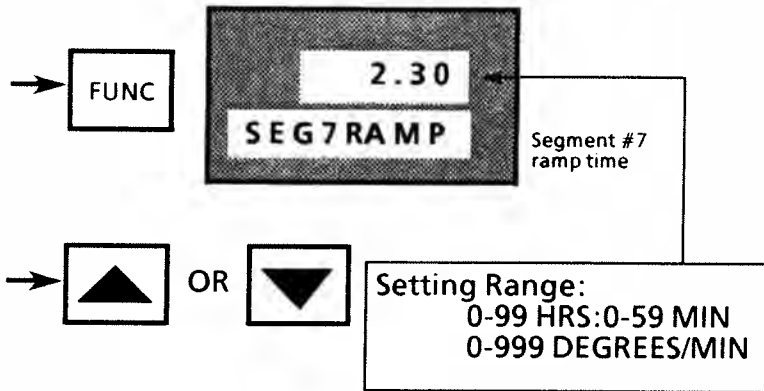

REMARKS
Ramp/Soak Profile Example
Select HRS:MIN or DEG/MIN
at prompt RAMP UNIT. All
ramps will use same selection.

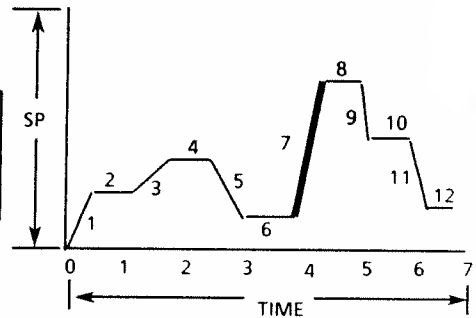

37. Use [RAISE] or [LOWER] key to set desired value in upper display or go to Step 38.

38. Press [FUNC] key to call up next parameter and enter present selection.

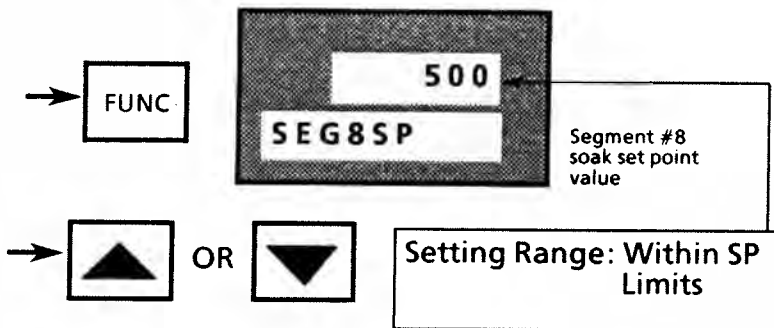

REMARKS
Ramp/Soak Profile Example

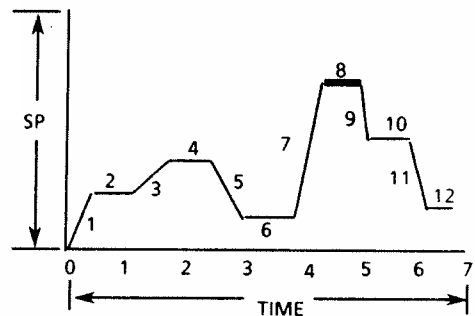

39. Use [RAISE] or [LOWER] key to set desired value in upper display or go to Step 40.

4 Configuring Your Recorder -- Continued

C. SP RAMP (PROGRAM) 1 Configuration -- Continued

40. Press [FUNC] key to call up next parameter and enter present selection.

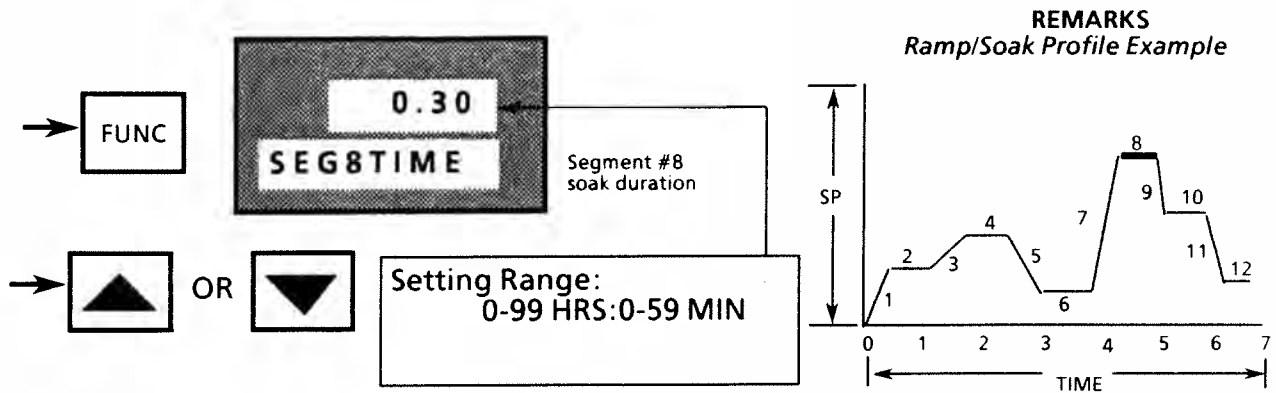

41. Use [RAISE] or [LOWER] key to set desired value in upper display or go to Step 42.

42. Press [FUNC] key to call up next parameter and enter present selection.

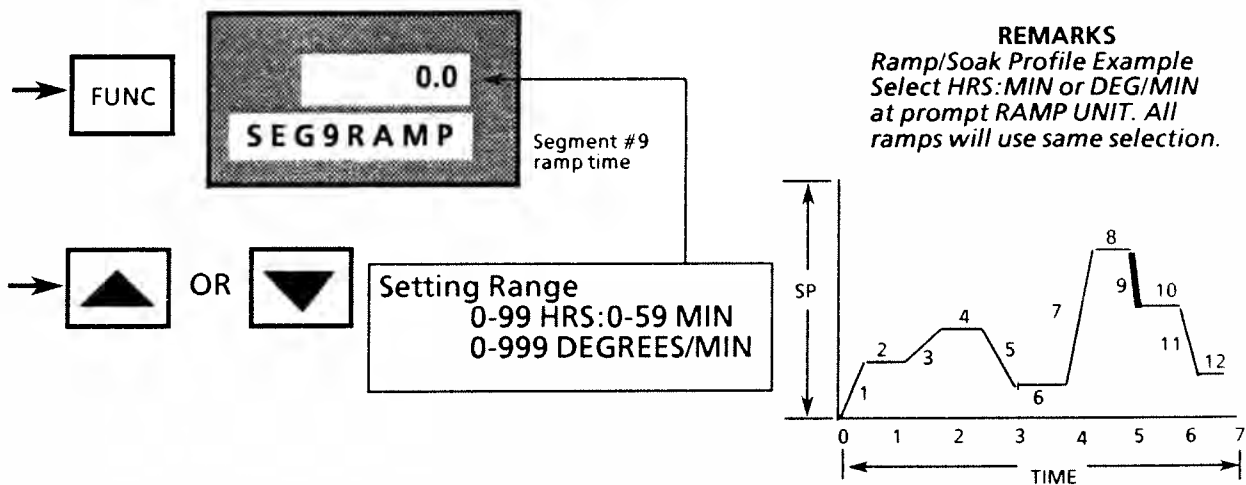

43. Use [RAISE] or [LOWER] key to set desired value in upper display or go to Step 44.

4 Configuring Your Recorder -- Continued

C. SP RAMP (PROGRAM) 1 Configuration -- Continued

44. Press [FUNC] key to call up next parameter and enter present selection.

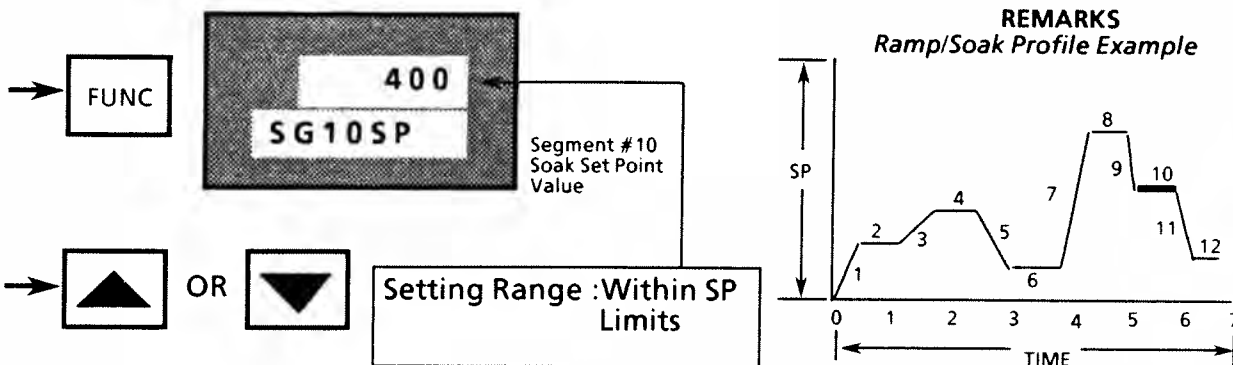

45. Use [RAISE] or [LOWER] key to set desired value in upper display or go to Step 46.

46. Press [FUNC] key to call up next parameter and enter present selection.

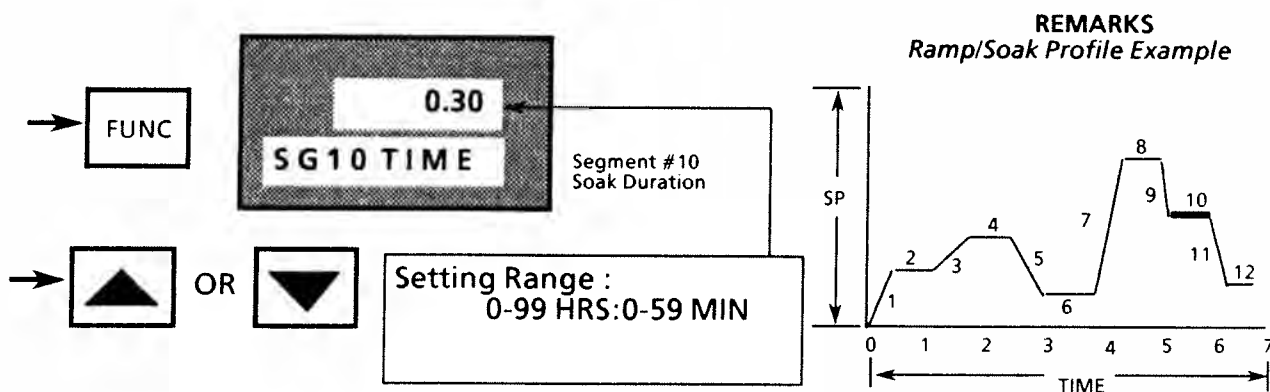

47. Use [RAISE] or [LOWER] key to set desired value in upper display or go to Step 48.

4 Configuring Your Recorder -- Continued

C. SP RAMP (PROGRAM) 1 Configuration -- Continued

48. Press [FUNC] key to call up next parameter and enter present selection.

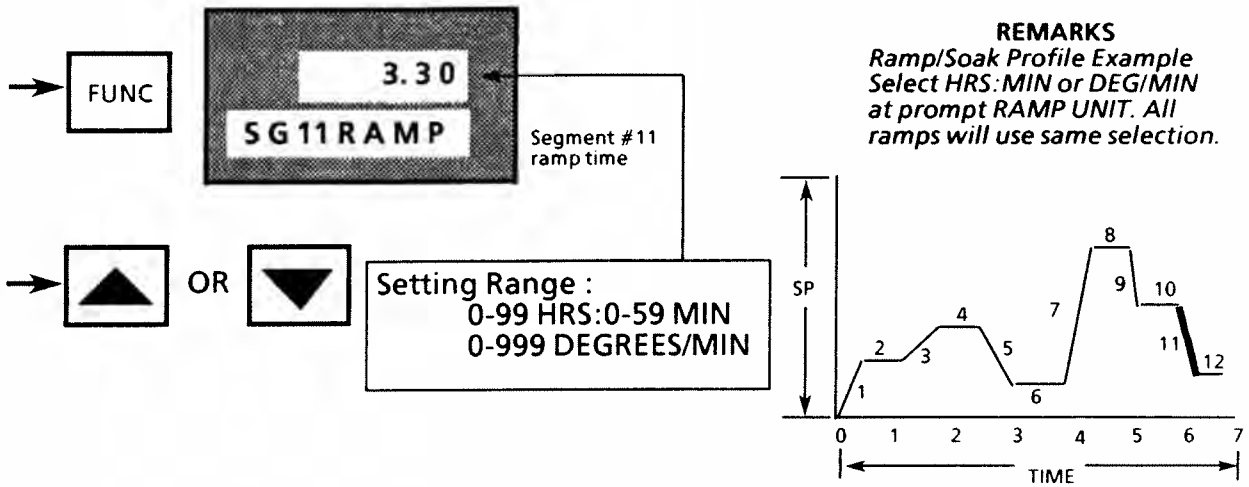

49. Use [RAISE] or [LOWER] key to set desired value in upper display or go to Step 50.

50. Press [FUNC] key to call up next parameter and enter present selection.

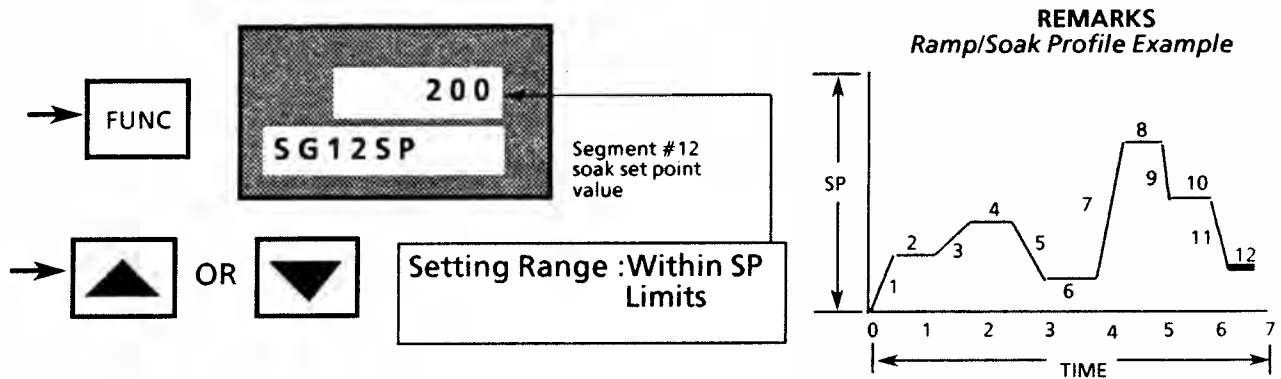

51. Use [RAISE] or [LOWER] key to set desired value in upper display or go to Step 52.

4 Configuring Your Recorder – Continued

C. SP RAMP (PROGRAM) 1 Configuration -- Continued

52. Press [FUNC] key to call up next parameter and enter present selection.

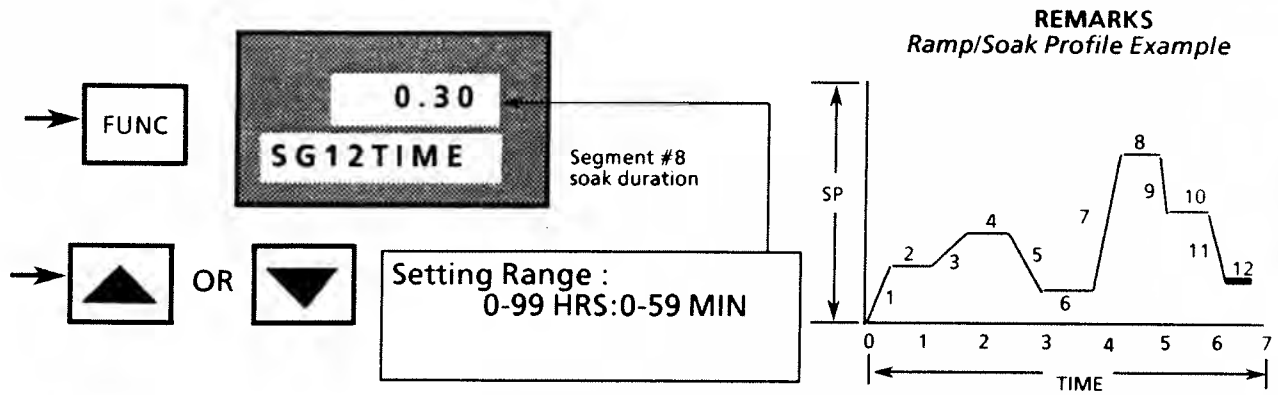

53. Use [RAISE] or [LOWER] key to set desired value in upper display or go to Step 54.

54. Press [FUNC] key to call up next parameter and enter present selection.

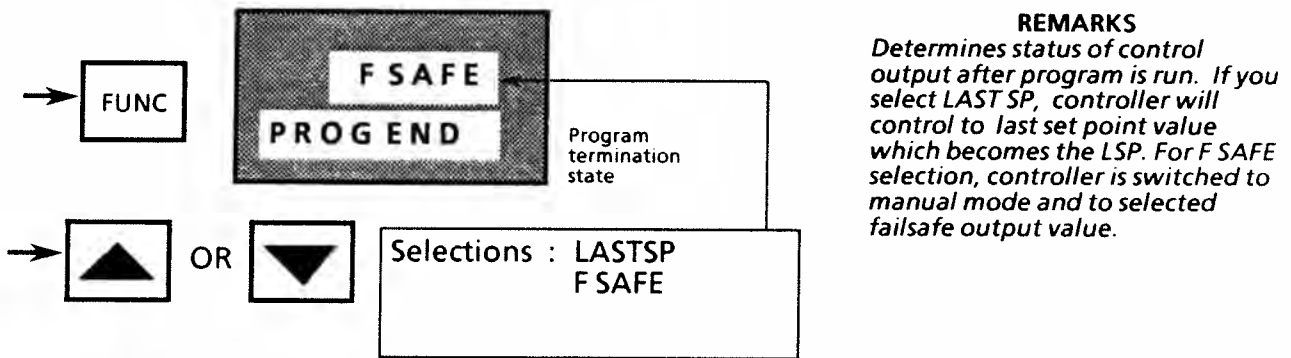

55. Use [RAISE] or [LOWER] key to make selection in upper display or go to Step 56.

4 Configuring Your Recorder – Continued

C. SP RAMP (PROGRAM) 1 Configuration -- Continued

56. Press [FUNC] key to call up next parameter and enter present selection.

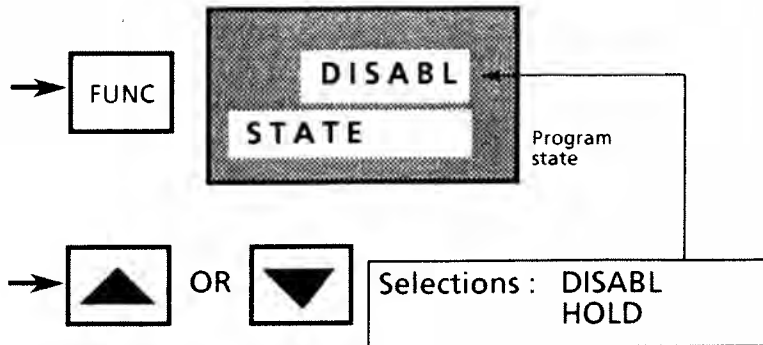

REMARKS
Determines state of the program after it completes the final program segment cycles. If you select DISABL, you must enable program through function prompt before you can run program again. If you select HOLD, you can run program again by pressing [RUN/HOLD] key.

57. Use [RAISE] or [LOWER] key to make selection in upper display to have program disabled or put into Hold mode after it is run, or go to Step 58.

58. Press [FUNC] key to call up next parameter and enter present selection.

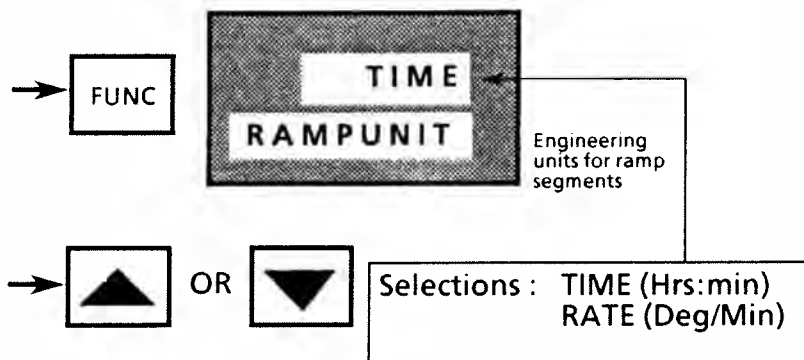

REMARKS
Selection applies for all ramp segments.

59. Use [RAISE] or [LOWER] key to select unit of measurement for ramp segments in program , or go to Step 60.

60. Press [SET UP] key to call up next group prompt and go to appropriate procedure in this section. Or, press [LOWR DISP] key to exit configuration mode.

REPEAT PROCEDURE FOR SP RAMP (PROGRAM) 2 CONFIGURATION

4 Configuring Your Recorder – Continued

D. CHART Configuration

Prerequisites:

- Required for all models
- Recorder door is open and power is ON.
- Keypad LOCKOUT configuration is NONE.

1. Press [SET UP] key to put recorder in Configuration (SET UP) Mode and call up CHART prompt in lower display. If recorder is in SET UP Mode, successively press [SET UP] key to step through group prompts or hold key in to scroll prompts until CHART appears in display.

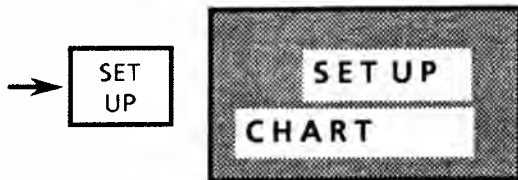

REMARKS
 If you want to abort (exit) configuration mode, press [LOWR DISP] key or don't press any key for 1 minute.

2. Press [FUNC] key to call up first parameter for configuration.

NOTE: Hold key in if you want to scroll through all the function prompts associated with this group.

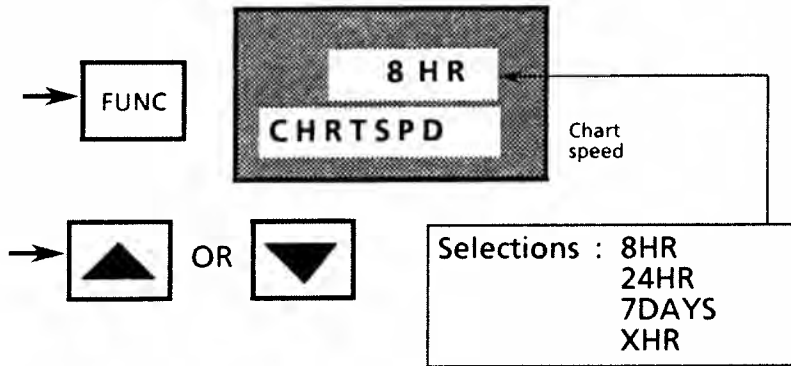

REMARKS
 Time it will take to drive chart one complete revolution

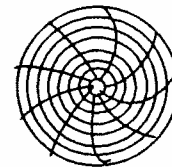

3. Use [RAISE] or [LOWER] key to select desired chart speed.
 - If you select XHR, go to Step 4; otherwise, go to Step 6.

NOTE: To recall original value or selection, press [RUN/HOLD] key before pressing [FUNC] key again.

4 Configuring Your Recorder – Continued

D. CHART Configuration -- Continued

4. Press [FUNC] key to call up next parameter and enter present selection.

Appears only if XHR chart speed was selected.

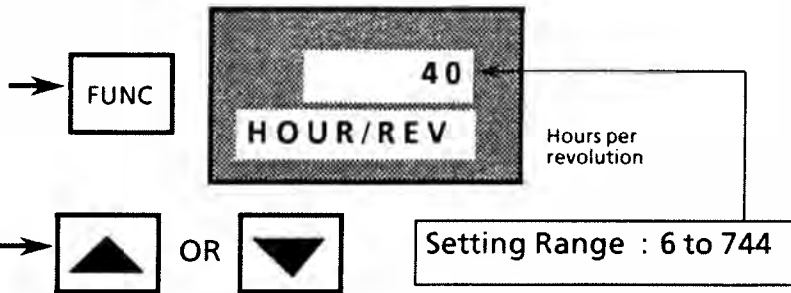

5. Use [RAISE] or [LOWER] key to set desired chart speed value in upper display or go to Step 6.

NOTE: If display blinks, you are trying to select an unacceptable value. You can change value more quickly by holding in one key [RAISE] or [LOWER] and pressing other one [LOWER] or [RAISE] at same time. Adjustment will move one digit to the left with each press.

6. Press [FUNC] key to call up next parameter and enter present selection.

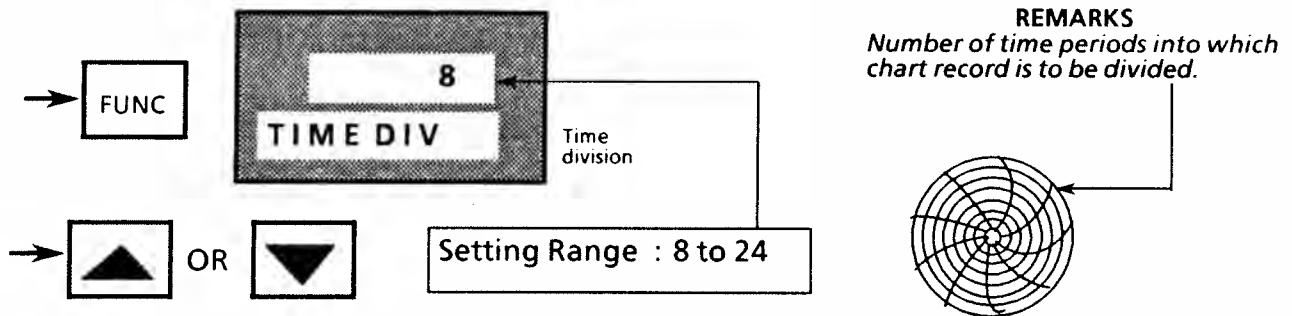

7. Use [RAISE] or [LOWER] key to set desired number of time periods into which chart record is to be divided or go to Step 8.

4 Configuring Your Recorder – Continued

D. CHART Configuration -- Continued

8. Press [FUNC] key to call up next parameter and enter present selection.

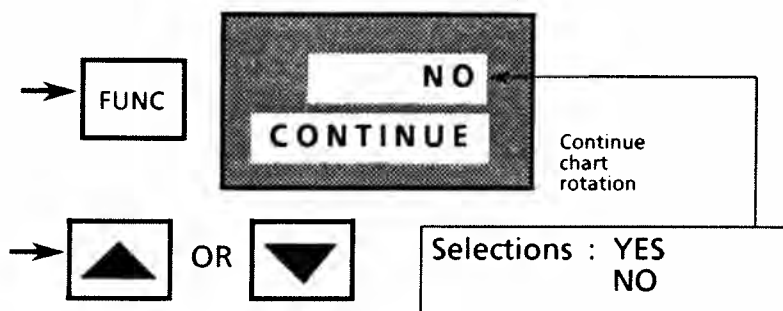

REMARKS
Do you want to continue chart drive after a single 360° rotation?

9. Use [RAISE] or [LOWER] key to select yes to continue or no to stop chart drive after single 360° rotation or go to Step 10.

10. Press [FUNC] key to call up next parameter and enter present selection.

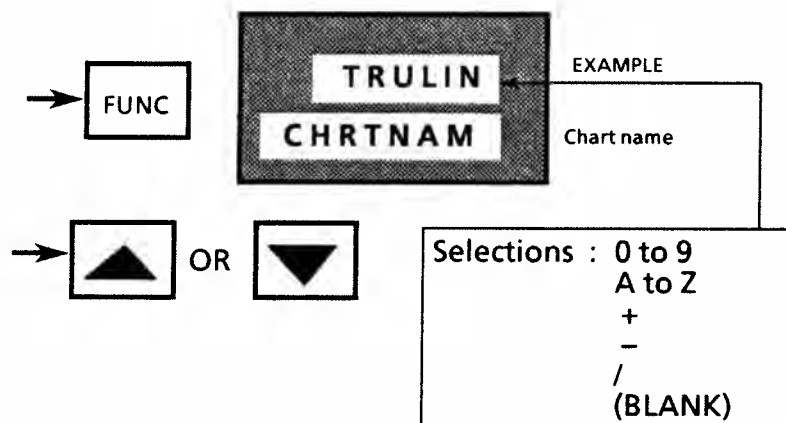

NOTE: For alphanumeric entries, the display will cycle, from left to right, with highlighting (increased brightness) of each digit. The value of each digit can be changed only when it is highlighted.

11. Use [RAISE] or [LOWER] key to create desired chart name identifier, or go to Step 12.

4 Configuring Your Recorder -- Continued

D. CHART Configuration -- Continued

12. Press [FUNC] key to call up next parameter and enter present selection.

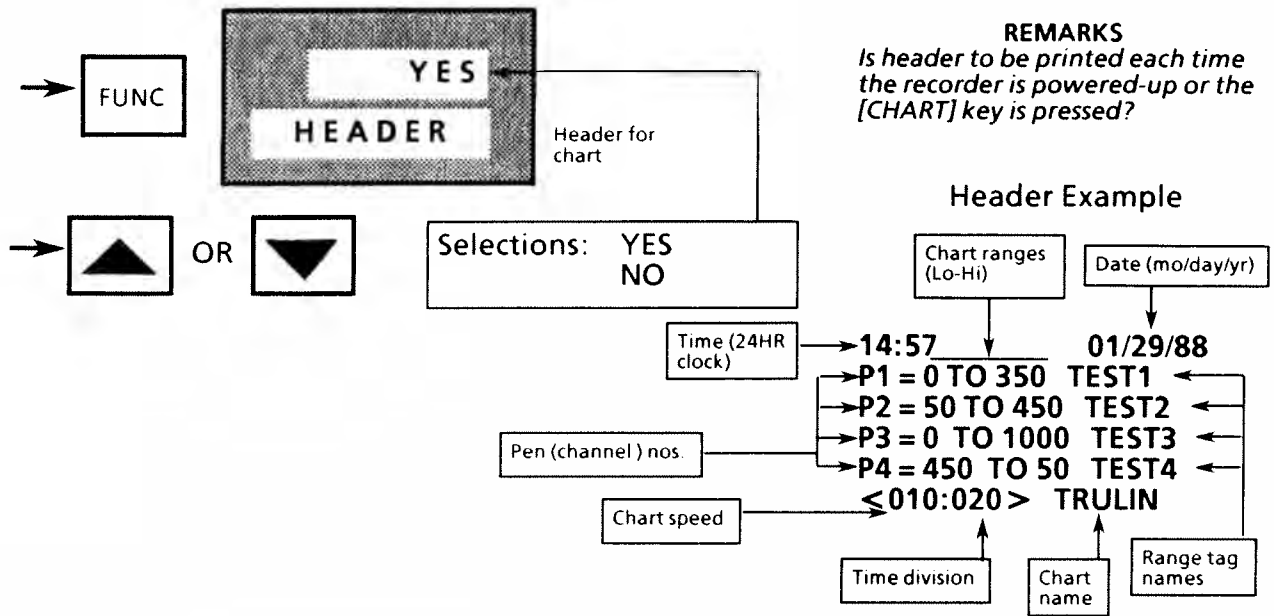

13. Use [RAISE] or [LOWER] key to select if you want header printed or not, or go to Step 14.

NOTE: If you select NO, only the chart name will be printed.

14. Press [FUNC] key to call up next parameter and enter present selection.

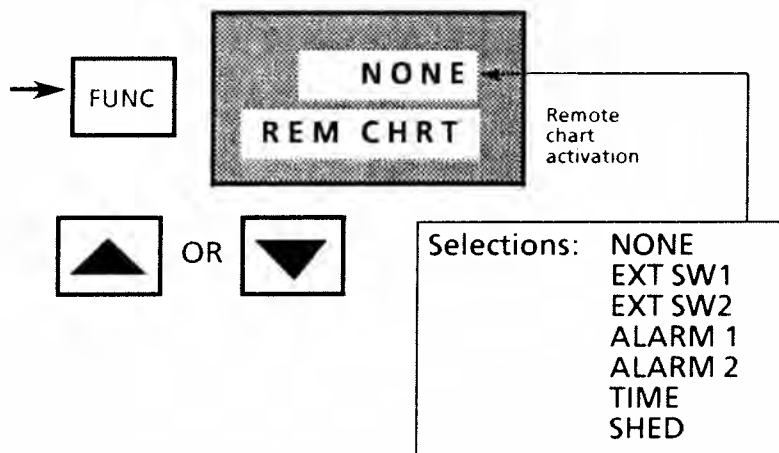

15. Use [RAISE] or [LOWER] key to select desired function to activate chart from a remote location or an internal signal.

- If you select TIME, go to Step 16; otherwise, go to step 20.

4 Configuring Your Recorder -- Continued

D. CHART Configuration -- Continued

16. Press [FUNC] key to call up next parameter and enter present selection.

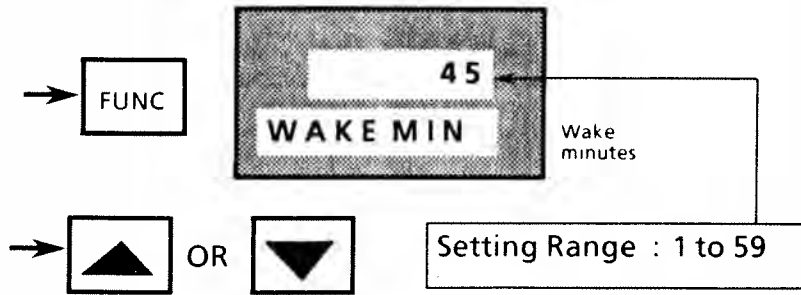

REMARKS
Wake time specifies time at which pen record will begin.



17. Use [RAISE] or [LOWER] key to set minutes for "wake" time, or go to Step 18.

18. Press [FUNC] key to call up next parameter and enter present selection.

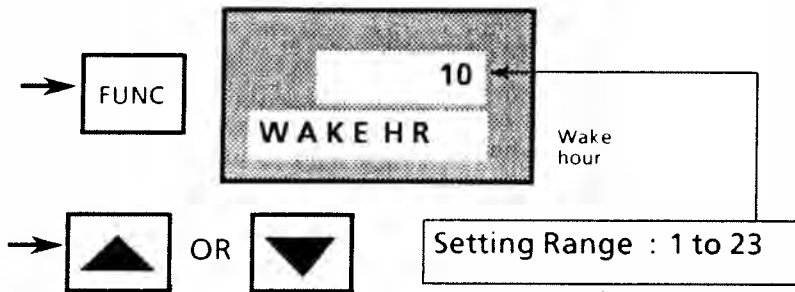

19. Use [RAISE] or [LOWER] key to set hours for "wake" time, or go to Step 20.

20. Press [SET UP] key to call up next group prompt and go to appropriate procedure in this section. Or, press [LOWR DISP] key to exit Configuration Mode.

4 Configuring Your Recorder -- Continued

E. TIME Configuration

Prerequisites:

- Required for all models
- Recorder door is open and power is ON.
- Keypad LOCKOUT configuration is NONE.

1. Press [SET UP] key to put recorder in Configuration (SET UP) Mode and call up TIME prompt in lower display. If recorder is in SET UP Mode, successively press [SET UP] key to step through group prompts or hold key in to scroll prompts until TIME appears in display.

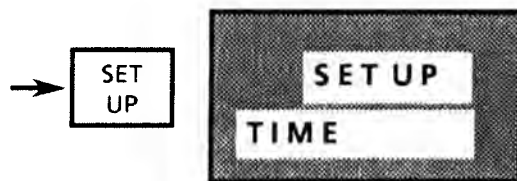

REMARKS
 If you want to abort (exit) configuration mode, press [LOWR DISP] key or don't press any key for 1 minute.

2. Press [FUNC] key to call up first parameter for real-time clock configuration.

NOTE: Hold key in if you want to scroll through all the function prompts associated with this group.

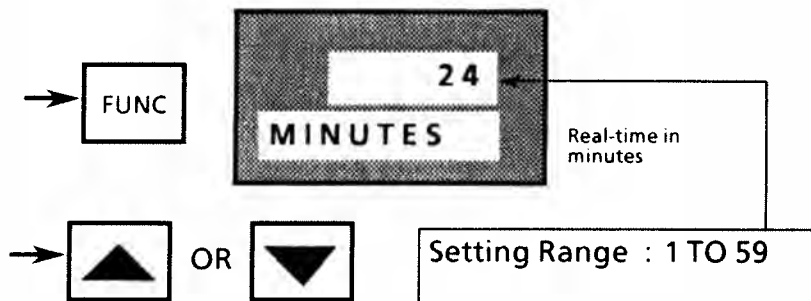

3. Use [RAISE] or [LOWER] key to set present time in minutes, or go to Step 4.

NOTE: To recall original value or selection, press [RUN/HOLD] key before pressing [FUNC] key again.

4 Configuring Your Recorder -- Continued

E. TIME Configuration -- Continued

4. Press [FUNC] key to call up next parameter and enter present selection.

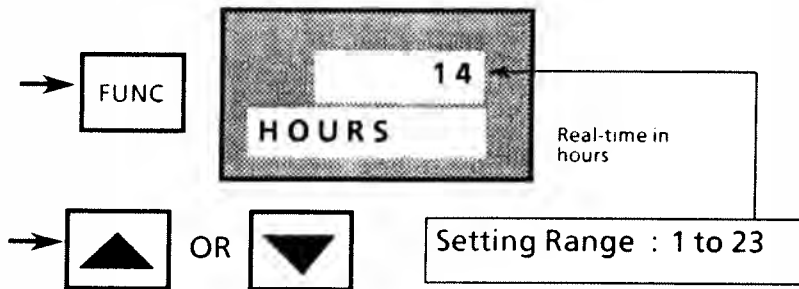

4

5. Use [RAISE] or [LOWER] key to set hour in 24HR clock format, or go to Step 6.

NOTE: If display blinks, you are trying to select an unacceptable value. You can change value more quickly by holding in one key [RAISE] or [LOWER] and pressing other one [LOWER] or [RAISE] at same time. Adjustment will move one digit to the left with each press.

6. Press [FUNC] key to call up next parameter and enter present selection.

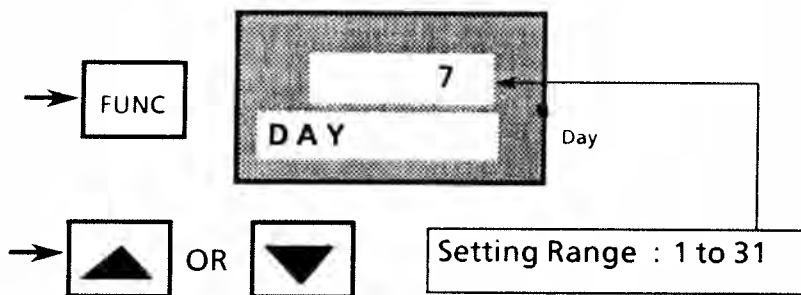

7. Use [RAISE] or [LOWER] key to set number corresponding to day, or go to Step 8.

4 Configuring Your Recorder -- Continued

E. TIME Configuration -- Continued

8. Press [FUNC] key to call up next parameter and enter present selection.

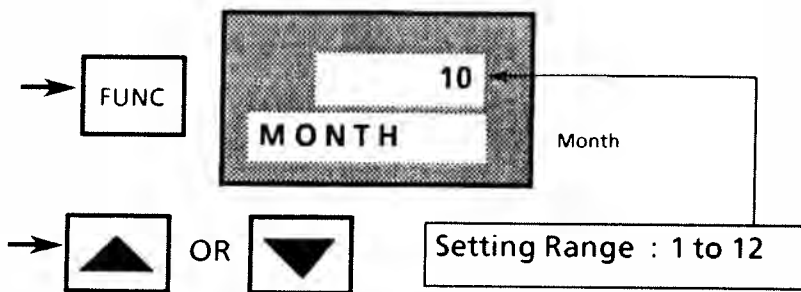

9. Use [RAISE] or [LOWER] key to set number corresponding to month, or go to Step 10.

NOTE: If display blinks, you are trying to select an unacceptable value. You can change value more quickly by holding in one key [RAISE] or [LOWER] and pressing other one [LOWER] or [RAISE] at same time. Adjustment will move one digit to the left with each press.

4 Configuring Your Recorder – Continued

E. TIME Configuration -- Continued

10. Press [FUNC] key to call up next parameter and enter present selection.

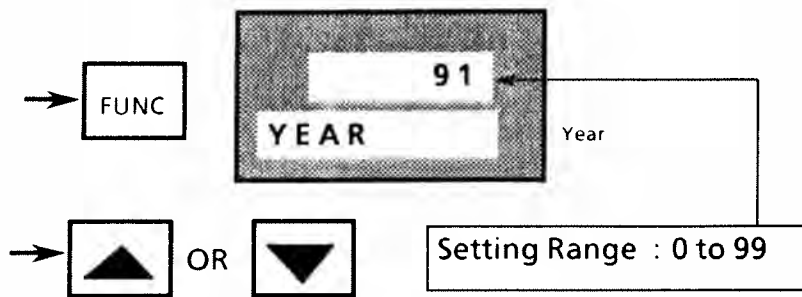

11. Use [RAISE] or [LOWER] key to set number corresponding to year, or go to Step 12.

4 Configuring Your Recorder -- Continued

E. TIME Configuration -- Continued

12. Press [FUNC] key to call up next parameter and enter present selection.

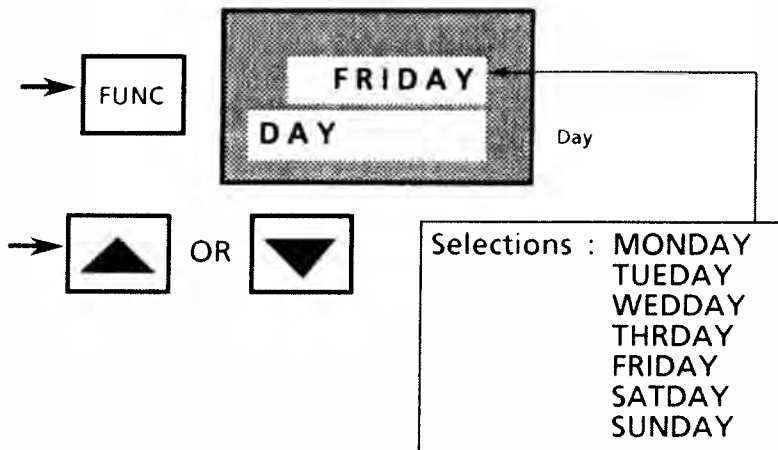

13. Use [RAISE] or [LOWER] key to select day of week, or go to Step 14.

14. Press [SET UP] key to call up next group prompt and go to appropriate procedure in this section. Or, press [LOWR DISP] key to exit Configuration Mode.

4 Configuring Your Recorder – Continued

F. PEN 1-2-3-4 Configuration

Prerequisites:

- Required for all models
- Recorder door is open and power is ON.
- Keypad LOCKOUT configuration is NONE.

1. Press [SET UP] key to put recorder in Configuration (SET UP) Mode and call up PEN 1 (or PEN 2, PEN 3, or PEN 4) prompt in lower display. If recorder is in SET UP Mode, successively press [SET UP] key to step through group prompts or hold key in to scroll prompts until PEN 1 (or PEN 2, PEN 3, or PEN 4) appears in display.

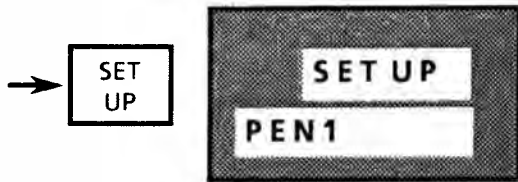

REMARKS
 If you want to abort (exit) configuration mode, press [LOWR DISP] or don't press any key for 1 minute.

2. Press [FUNC] key to call up first parameter for configuration.

NOTE: Hold key in if you want to scroll through all the function prompts associated with this group.

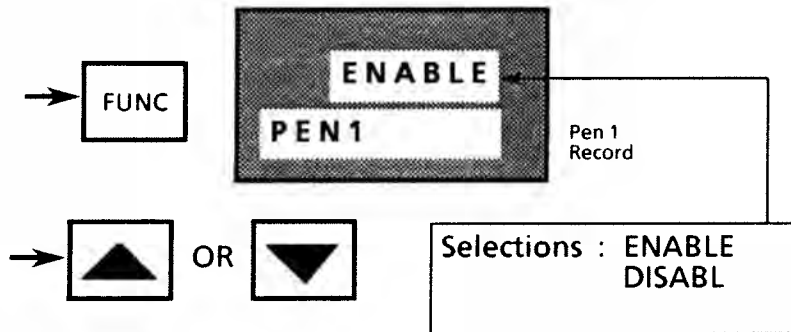

3. Use [RAISE] or [LOWER] key to “enable” or “disable” pen (channel) 1 record, or go to Step 4.

NOTE: To recall original value or selection, press [RUN/HOLD] key before pressing [FUNC] key again.

4 Configuring Your Recorder – Continued

F. PEN 1-2-3-4 Configuration -- Continued

4. Press [FUNC] key to call up next parameter and enter present selection.

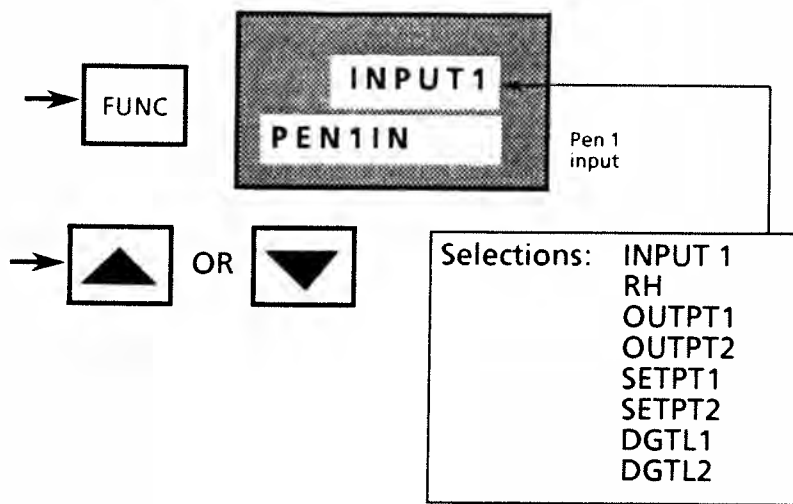

REMARKS

Do you want pen 1 (pen 2, pen 3, or pen 4) to record input, Relative Humidity, set point, or output. RH initiates an internal calculation for measuring Relative Humidity in %RH. In this case, second input must be enabled and configured as RH. Note that RH prompt only appears when REL HUMID prompt in OPTIONS group is configured as YES.

Use DGTL1 and/or DGTL2 for "EVENT" pen function through contact closure across digital 1 input and/or digital 2 input.

5. Use [RAISE] or [LOWER] key to select desired input for pen 1 (pen 2, pen 3, or pen 4) or go to Step 6.

NOTE: To recall original value or selection, press [RUN/HOLD] key before pressing [FUNC] key again.

6. Press [FUNC] key to call up next parameter and enter present selection.

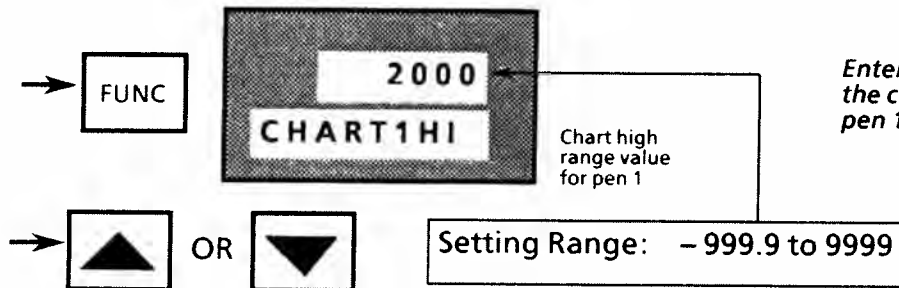

REMARKS

Enter value that corresponds with the chart high range value for pen 1 (pen 2, pen 3, or pen 4).

7. Use [RAISE] or [LOWER] key to set desired high range value for chart in upper display or go to Step 8.

NOTE: If display blinks, you are trying to select an unacceptable value. You can change value more quickly by holding in one key [RAISE] or [LOWER] and pressing other one [LOWER] or [RAISE] at same time. Adjustment will move one digit to the left with each press.

4 Configuring Your Recorder -- Continued

F. PEN 1-2-3-4 Configuration -- Continued

8. Press [FUNC] key to call up next parameter and enter present selection.

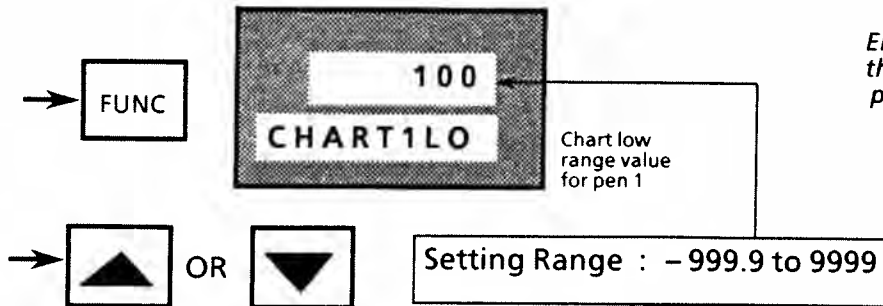

REMARKS
Enter value that corresponds with the chart low range value for pen 1 (pen 2, pen 3, or pen 4).

9. Use [RAISE] or [LOWER] key to set desired low range value for chart in upper display or go to Step 10.

10. Press [FUNC] key to call up next parameter and enter present selection.

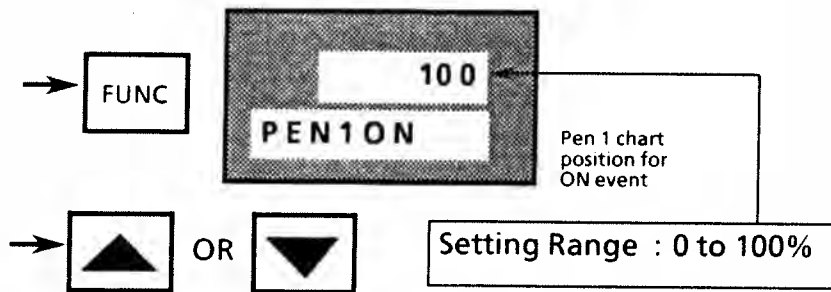

REMARKS
Event marker configuration using digital inputs. Prompt only appears if DGTL 1 or 2 is selected as pen 1 (pen 2, pen 3, or pen 4) input.

11. Use [RAISE] or [LOWER] key to select chart position where pen 1 (pen 2, pen 3, or pen 4) is to mark (trace) occurrence of an ON event, or go to Step 12.

4 Configuring Your Recorder – Continued

F. PEN 1-2-3-4 Configuration -- Continued

12. Press [FUNC] key to call up next parameter and enter present selection.

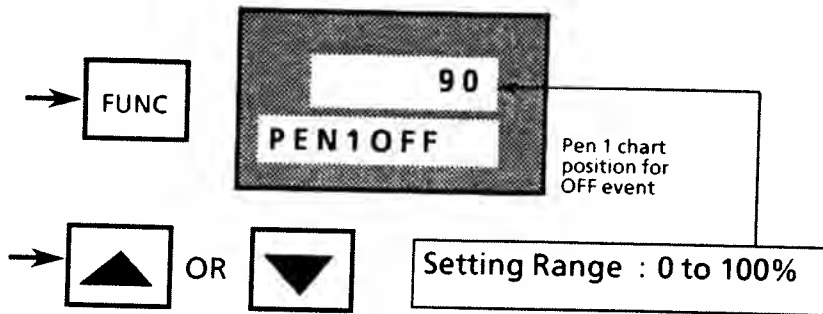

REMARKS
 Event marker configuration using digital inputs. Prompt only appears if DGTL 1 or 2 is selected as pen 1 (pen 2, pen 3, or pen 4) input.

13. Use [RAISE] or [LOWER] key to select chart position where pen 1 (pen 2, pen 3, or pen 4) is to mark (trace) occurrence of an OFF event, or go to Step 14.

14. Press [FUNC] key to call up next parameter and enter present selection.

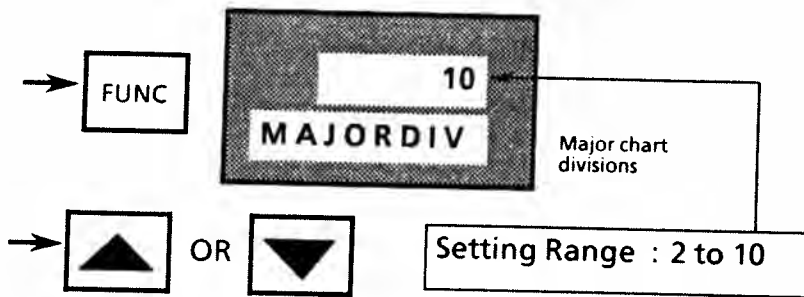

REMARKS
 Number of Major Divisions in range of Chart 1 (2,3, or 4) scale (between CHART1HI AND CHART1LO).

15. Use [RAISE] or [LOWER] key to set number of major divisions in chart, or go to Step 16.
 NOTE: If display blinks, you are trying to select an unacceptable value. You can change value more quickly by holding in one key [RAISE] or [LOWER] and pressing other one [LOWER] or [RAISE] at same time. Adjustment will move one digit to the left with each press.

4 Configuring Your Recorder – Continued

F. PEN 1-2-3-4 Configuration -- Continued

16. Press [FUNC] key to call up next parameter and enter present selection.

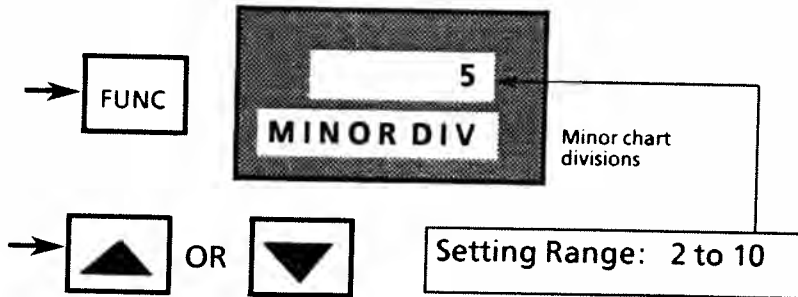

REMARKS
 Number of Minor Divisions in range of Chart 1 (2, 3, or 4) scale (increments in each Major Division).

17. Use [RAISE] or [LOWER] key to set number of minor divisions in chart, or go to Step 18.

18. Press [FUNC] key to call up next parameter and enter present selection.

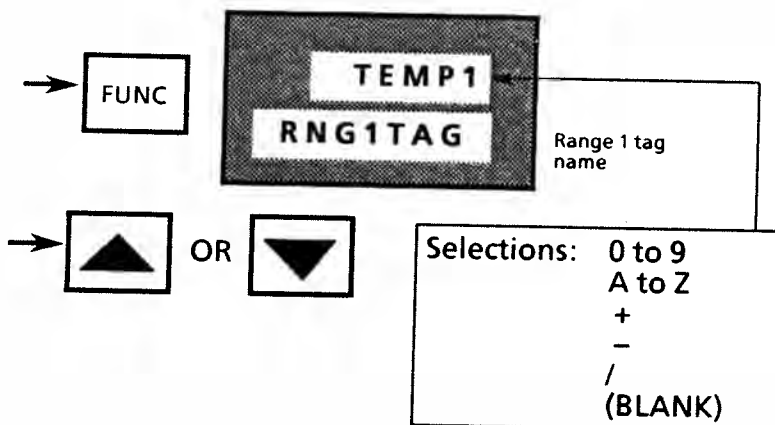

REMARKS
 Tag name for chart 1 (2, 3, or 4) range - up to 5 characters.

NOTE: For alphanumeric entries, the display will cycle, from left to right, with highlighting (increased brightness) of each digit. The value of each digit can be changed only when it is highlighted.

19. Use [RAISE] or [LOWER] key to enter desired tag name for chart 1 (2, 3, or 4) range, or go to Step 20.

20. Press [SET UP] key to call up next group prompt and go to appropriate procedure in this section. Or, press [LOWR DISP] key to exit Configuration Mode.

REPEAT PROCEDURE FOR PEN 2, PEN 3, AND PEN 4 CONFIGURATION

4 Configuring Your Recorder – Continued

G. INPUT 1-2-3-4 Configuration

Prerequisites:

- Required for all models
- Recorder door is open and power is ON.
- Function prompt INPUT 1 (2, 3, or 4) in OPTIONS group is ENABLED.
- Keypad LOCKOUT configuration is NONE.

1. Press [SET UP] key to put recorder in Configuration (SET UP) Mode and call up INPUT 1 (INPUT 2, INPUT 3, or INPUT 4) prompt in lower display. If recorder is in SET UP Mode, successively press [SET UP] key to step through group prompts or hold key in to scroll prompts until INPUT 1 (INPUT 2, INPUT 3, or INPUT 4) appears in display.

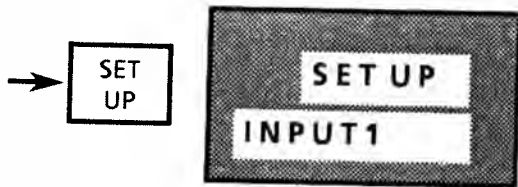

REMARKS
 If you want to abort (exit) configuration, press [LOWR DISP] key or don't press any key for 1 minute.

2. Press [FUNC] key to call up first input parameter for configuration.

NOTE: Hold key in if you want to scroll through all the function prompts associated with this group.

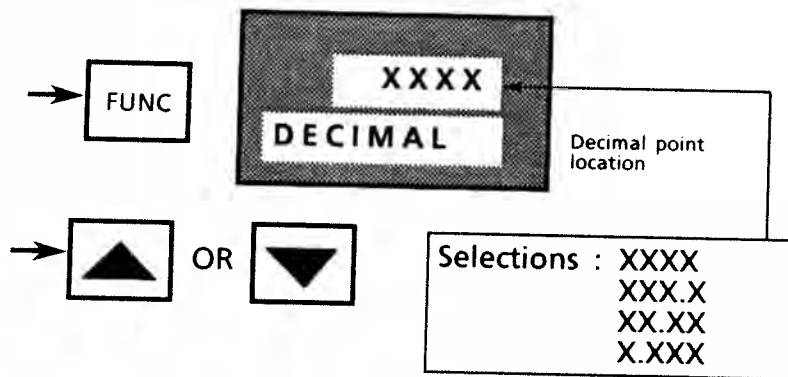

REMARKS
 Be sure that selection agrees with value to be displayed. If PV requires 4 whole digits, decimal will not show.

3. Use [RAISE] or [LOWER] key to select decimal location for PV display, or go to Step 4.

NOTE: To recall original value or selection, press [RUN/HOLD] (or [] blank) key before pressing [FUNC] key again.

4 Configuring Your Recorder -- Continued

G. INPUT 1-2-3-4 Configuration -- Continued

4. Press [FUNC] key to call up next parameter and enter present selection.

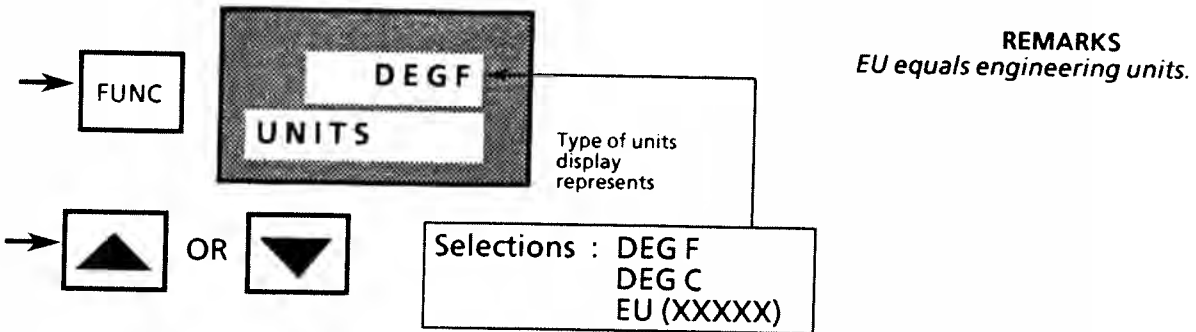

5. Use [RAISE] or [LOWER] key to select units for PV display.

- If you select EU, go to Step 6; otherwise, go to Step 8.

6. Press [FUNC] key to call up next parameter and enter present selection.

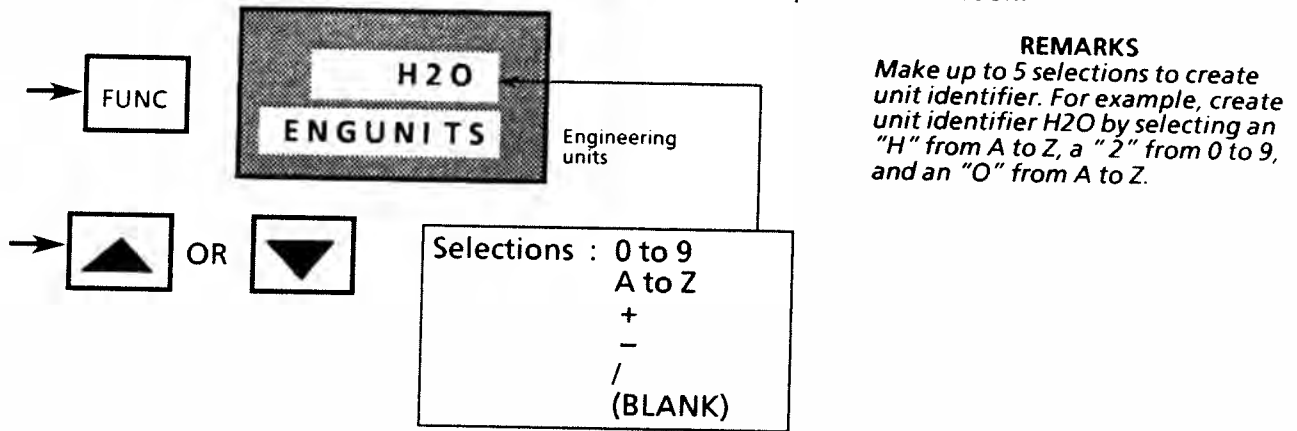

NOTE: For alphanumeric entries, the display will cycle, from left to right, with highlighting (increased brightness) of each digit. The value of each digit can be changed only when it is highlighted.

7. Use [RAISE] or [LOWER] key to create desired engineering unit identifier, or go to Step 8.

4 Configuring Your Recorder – Continued

G. INPUT 1-2-3-4 Configuration -- Continued

8. Press [FUNC] key to call up next parameter and enter present selection.

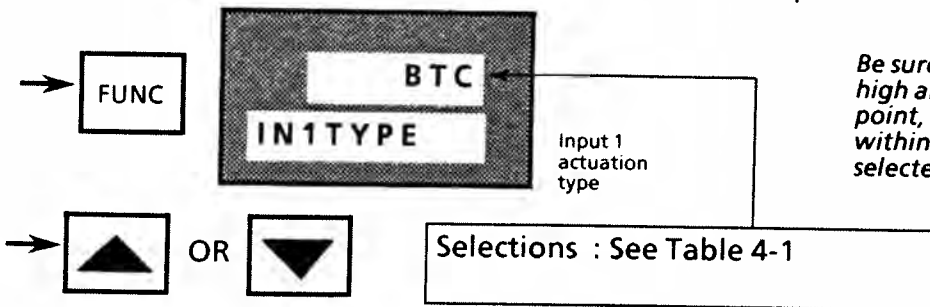

REMARKS
Be sure that values configured for high and low chart range, soak set point, alarm set point, etc. are within measuring range for selected actuation type.

9. Use [RAISE] or [LOWER] key to select actuation type.

- If you select a mA, mV, or V (linear) actuation, go to Step 10; otherwise, go to Step 12.

10. Press [FUNC] key to call up next parameter and enter present selection.

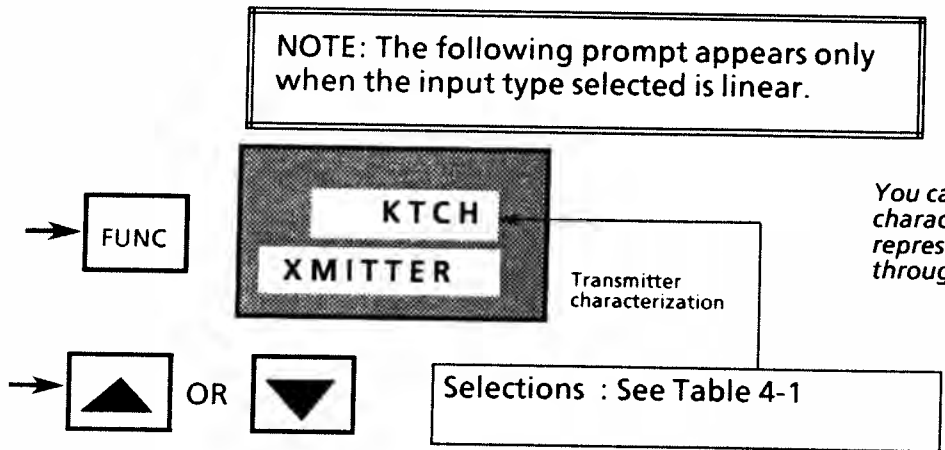

REMARKS.
You can tell recorder to characterize a linear input to represent a non-linear one through this selection.

11. Use [RAISE] or [LOWER] key to select actuation type, or go to Step 12.

4 Configuring Your Recorder – Continued

G. INPUT 1-2-3-4 Configuration -- Continued

Table 4-1 - Input Actuation/Transmitter Reference Data

Selections	Actuation Type	Range	
		°F	°C
B TC ¹	B	105 to 3300	41 to 1816
E TC H	E (high)	-454 to 1832	-270 to 1000
E TC L	E (low)	-200 to 1100	-129 to 593
J TC H	J (high)	0 to 1600	-18 to 871
J TC L	J (low)	20 to 770	-7 to 410
K TC H	K (high)	-320 to 2500	-196 to 1371
K TC L	K (low)	-20 to 1000	-29 to 538
NNM TC ¹	Ni Ni Moly	32 to 2500	0 to 1371
NIC TC ¹	Nicrosil-Nisil	0 to 2372	-17 to 1300
R TC ¹	R	0 to 3100	-18 to 1704
S TC	S	0 to 3100	-18 to 1704
T TC H	T (high)	-300 to 700	-184 to 371
T TC L	T (low)	-200 to 600	-129 to 316
W TC H ¹	W (high)	0 to 4200	-18 to 2315
W TC L ¹	W (low)	0 to 2240	-18 to 1227
	RTD		
100 PT	100 ohm PT	-300 to 900	-184 to 482
200 HI ²	200 ohm PT	32 to 752	0 to 400
200 LO ²	200 ohm PT	32 to 392	0 to 200
500 PT	500 ohm PT	-300 to 900	-184 to 482
100 RH	100 ohm PT	-130 to 392	-90 to 200
	LINEAR*		
4-20mA**	4-20 mA		
0-10mV	0-10 mV		
10-50m	10-50 mV		
0-5 V	0-5 Vdc		
0-10 V	0-10 Vdc		
	XMITTER***		
LINEAR	Linear	-999.9 to 9999	
SQROOT	Square Root	-999.9 to 9999	

*These selections appear only with IN1TYPE, IN2TYPE, IN3TYPE, or IN4TYPE prompt.

**Resistor / Transorb assembly 30756461-002 (supplied with recorder) must be installed in input when using this range.

***These selections appear only with XMITTER prompt, which appears only if a linear type is configured for input type.

¹ Only available with Model DR 450T.

² Only available with Model DR 450R.

4 Configuring Your Recorder – Continued

G. INPUT 1-2-3-4 Configuration -- Continued

12. Press [FUNC] key to call up next parameter and enter present selection.

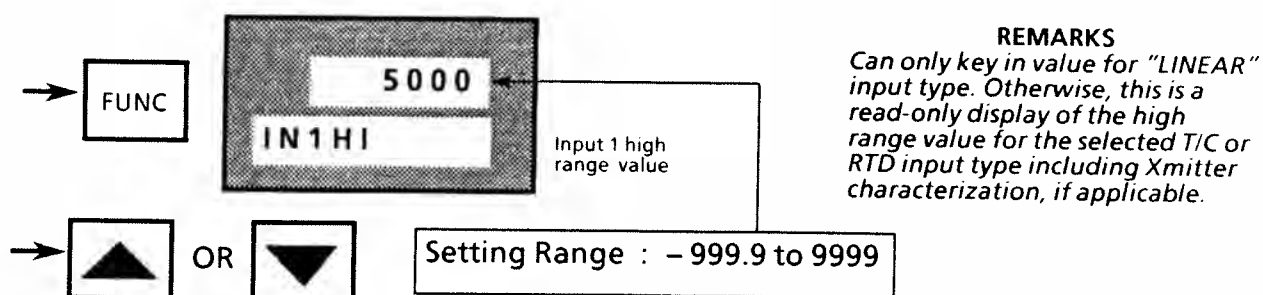

13. Use [RAISE] or [LOWER] key to set high range value for linear input, or go to Step 14.

NOTE: If display blinks, you are trying to select an unacceptable value. You can change value more quickly by holding in one key [RAISE] or [LOWER] and pressing other one [LOWER] or [RAISE] at same time. Adjustment will move one digit to the left with each press.

14. Press [FUNC] key to call up next parameter and enter present selection.

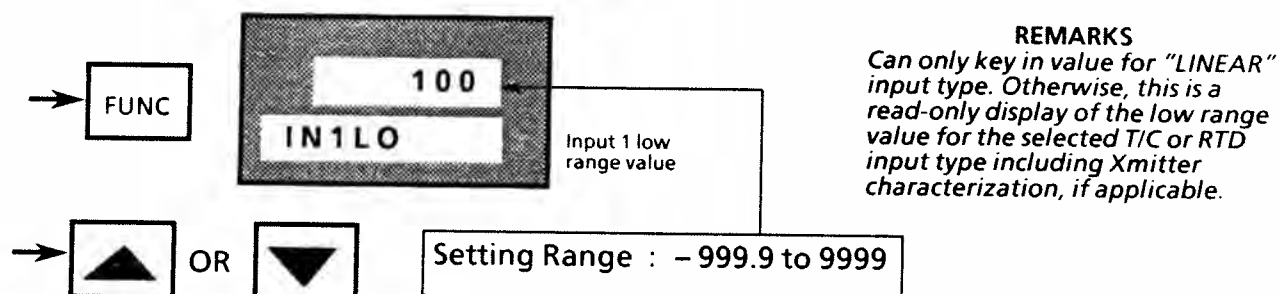

15. Use [RAISE] or [LOWER] key to set low range value for linear input, or go to Step 16.

4 Configuring Your Recorder – Continued

G. INPUT 1-2-3-4 Configuration -- Continued

16. Press [FUNC] key to call up next parameter and enter present selection.

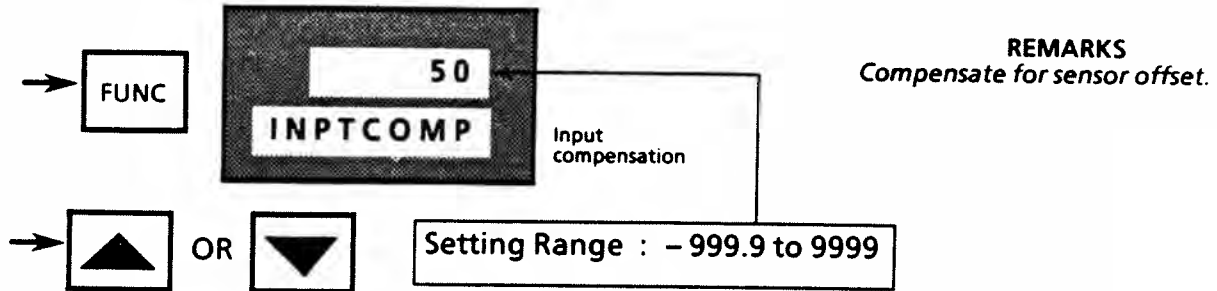

4

17. Use [RAISE] or [LOWER] key to set desired input compensation or go to Step 18.

NOTE: If display blinks, you are trying to select an unacceptable value. You can change value more quickly by holding in one key [RAISE] or [LOWER] and pressing other one [LOWER] or [RAISE] at same time. Adjustment will move one digit to the left with each press.

18. Press [FUNC] key to call up next parameter and enter present selection.

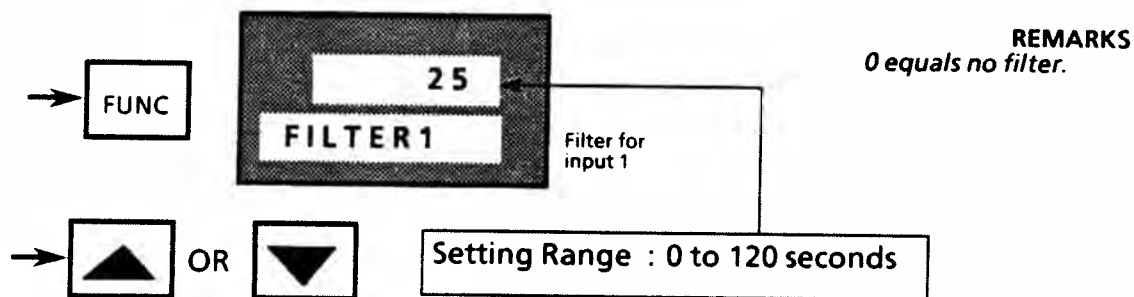

19. Use [RAISE] or [LOWER] key to set filter action on input 1, if desired, or go to Step 20.

4 Configuring Your Recorder – Continued

G. INPUT 1-2-3-4 Configuration -- Continued

20. Press [FUNC] key to call up next parameter and enter present selection.

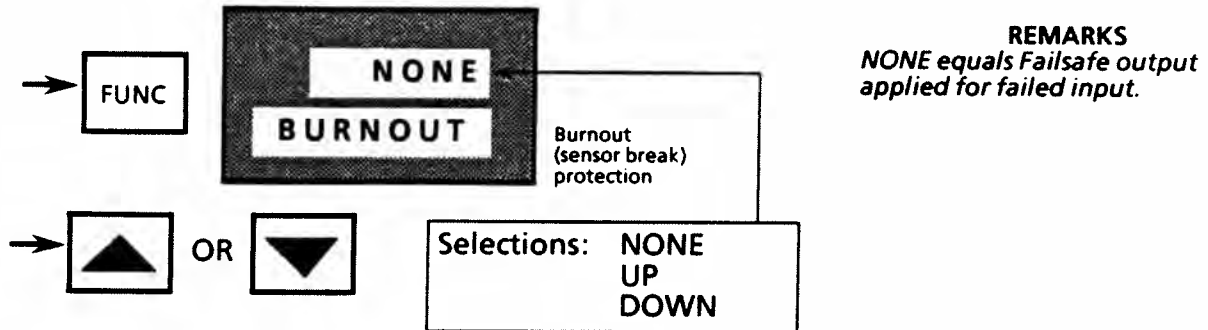

21. Use [RAISE] or [LOWER] key to select desired burnout action, or go to Step 22.

22. Press [SET UP] key to call up next group prompt and go to appropriate procedure in this section. Or, press [LOWR DISP] key to exit Configuration Mode.

REPEAT PROCEDURE FOR INPUT 2, INPUT 3, AND INPUT 4 CONFIGURATION

4 Configuring Your Recorder – Continued

H. TOTAL 1 and TOTAL 2 Configuration

Prerequisites:

- Table IV = A or E per Model Number
- Recorder door is open and power is ON.
- Keypad LOCKOUT configuration is NONE.

1. Press [SET UP] key to put recorder in Configuration (SET UP) Mode and call up TOTAL 1 (or TOTAL 2) prompt in lower display. If recorder is in SET UP Mode, successively press [SET UP] key to step through group prompts or hold key in to scroll prompts until TOTAL 1 (or TOTAL 2) appears in display.

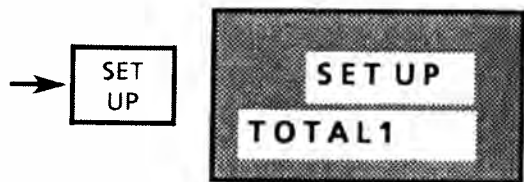

REMARKS
 If you want to abort (exit) configuration, press [LOWR DISP] key or don't press any key for 1 minute.

2. Press [FUNC] key to call up totalization parameter for viewing and/or configuration.

NOTE: Hold key in if you want to scroll through all the function prompts associated with this group. However, if the TOTAL 1 (or TOTAL 2) function prompt is "disabled", you must go to Step 6 to "enable" it before the other prompts listed here will appear.

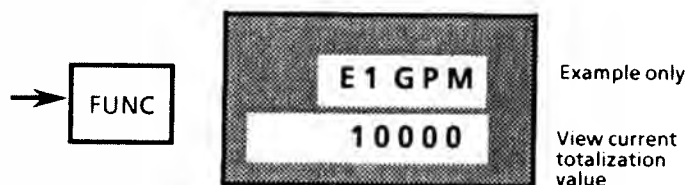

REMARKS
 E1 represents exponential value of total; i.e. total times 10¹. GPM represents total engineering units selected. See SCALER and TOTAL EU function prompts for selections.

3. Press [FUNC] key to call up next parameter for configuration.

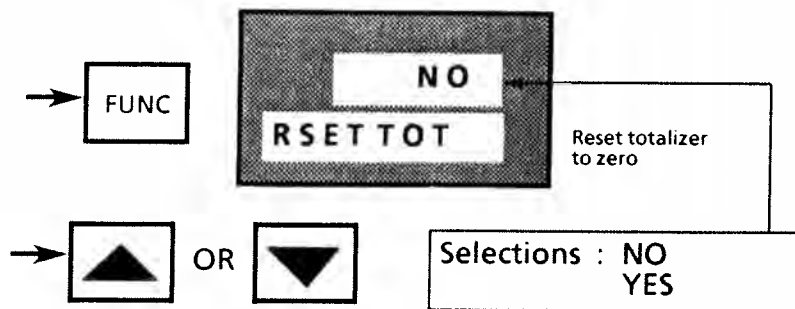

REMARKS
 To reset, must select "YES" under RSETABLE prompt. See Step 13 .

4. Use [RAISE] or [LOWER] key to select YES to reset totalization value to zero, or go to Step 5.

4 Configuring Your Recorder – Continued

H. TOTAL 1 and TOTAL 2 Configuration -- Continued

5. Press [FUNC] key to call up next parameter and enter present selection.

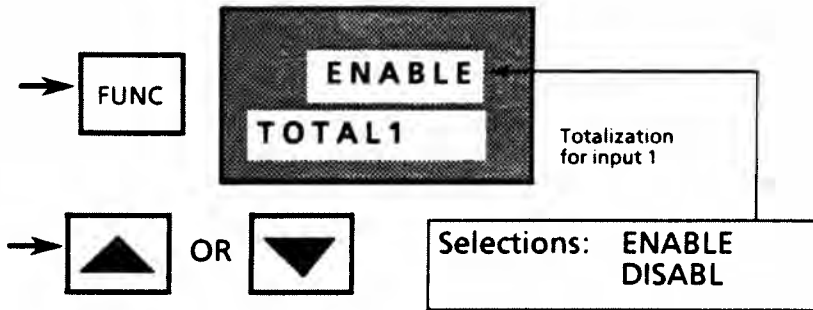

REMARKS
This prompt appears first when DISABL is selected.

6. Use [RAISE] or [LOWER] key to “enable” or “disable” totalization function.

- If you select DISABL, go to Step 15 ; otherwise, go to Step 7.

7. Press [FUNC] key to call up next parameter and enter present selection.

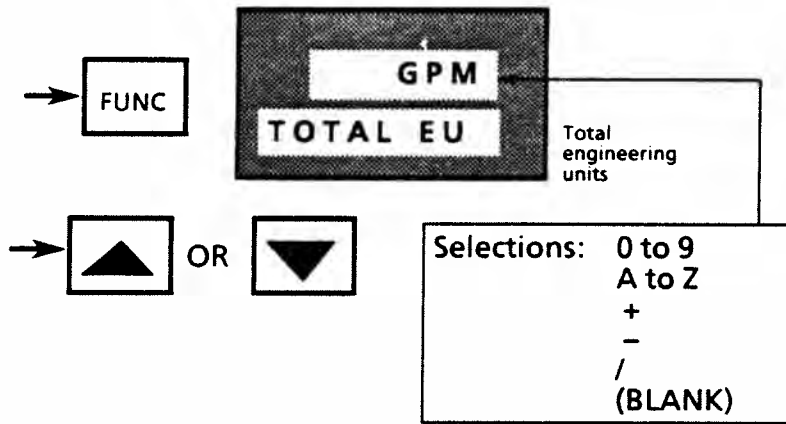

REMARKS
Make up to 3 selections to create unit identifier That total represents.

NOTE: For alphanumeric entries, the display will cycle, from left to right, with highlighting (increased brightness) of each digit. The value of each digit can be changed only when it is highlighted.

8. Use [RAISE] or [LOWER] key to create desired engineering unit identifier, or go to Step 9.

4 Configuring Your Recorder -- Continued

H. TOTAL 1 and TOTAL 2 Configuration -- Continued

9. Press [FUNC] key to call up next parameter and enter present selection.

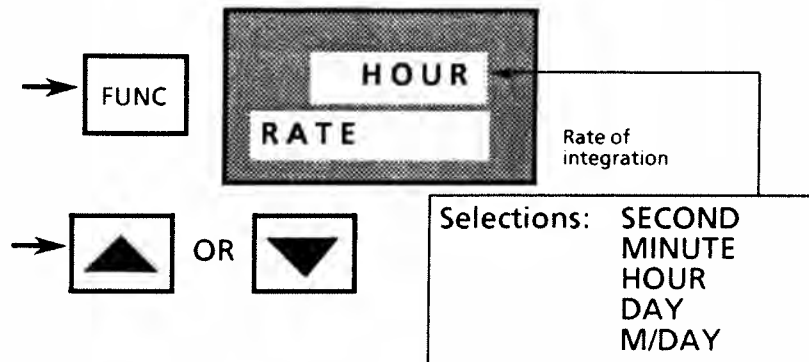

10. Use [RAISE] or [LOWER] key to select desired rate of integration, or go to Step 11.

11. Press [FUNC] key to call up next parameter and enter present selection.

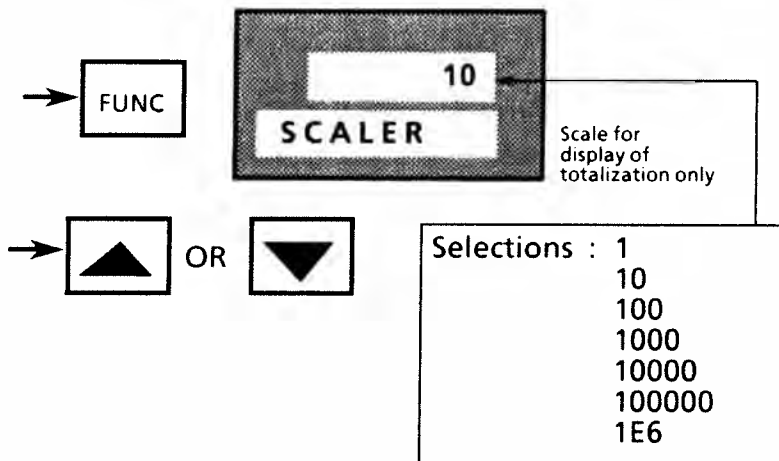

REMARKS
1E6 equals 1 times 10⁶.

Scaler selection does not affect totalization value printed on chart.

12. Use [RAISE] or [LOWER] key to select desired scaler for totalization value display, or go to Step 13.

4 Configuring Your Recorder – Continued

H. TOTAL 1 and TOTAL 2 Configuration -- Continued

13. Press [FUNC] key to call up next parameter and enter present selection.

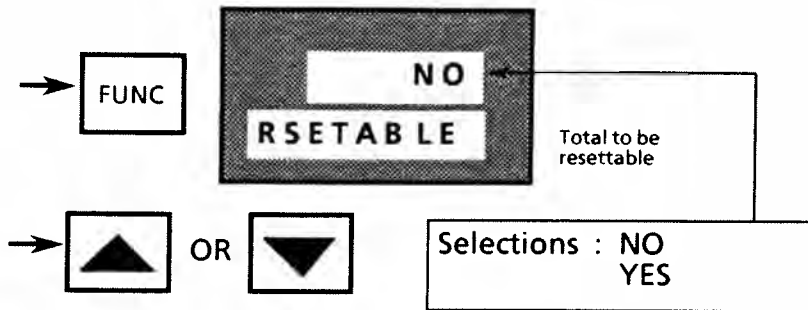

14. Use [RAISE] or [LOWER] key to allow totalized value to be reset or not, or go to Step 15.

15. Press [SET UP] key to call up next group prompt and go to appropriate procedure in this section. Or, press [LOWR DISP] key to exit Configuration Mode.

REPEAT PROCEDURE FOR TOTAL 2 CONFIGURATION

4 Configuring Your Recorder – Continued

I. CONTROL 1 and CONTROL 2 Configuration

Prerequisites:

- Table II = 1X or 4X/11, 14, 41, or 44 per Model Number
- Recorder door is open and power is ON.
- Function prompt CONTROL 1 (or CONTROL2) in OPTIONS group is enabled.
- See Appendix A for more details about control related parameters.
- Keypad LOCKOUT configuration is NONE.

1. Press [SET UP] key to put recorder in Configuration (SET UP) Mode and call up CONTROL 1 (CONTROL 2) prompt in lower display. If recorder is in SET UP Mode, successively press [SET UP] key to step through group prompts or hold key in to scroll prompts until CONTROL 1 (CONTROL 2) appears in display.



REMARKS
 If you want to abort (exit) configuration, press [LOWR DISP] key or don't press any key for 1 minute.

2. Press [FUNC] key to call up first control parameter for configuration.

NOTE: Hold key in if you want to scroll through all the function prompts associated with this group.

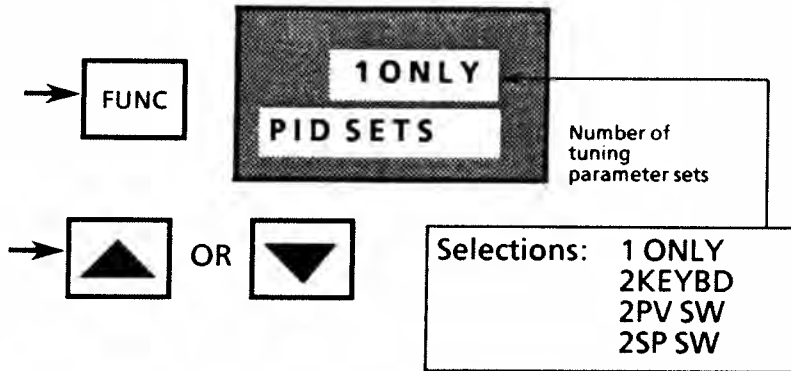

REMARKS
 Display does not appear when duplex algorithm is selected.

3. Use [RAISE] or [LOWER] key to select number of PID sets and how they are to be switched into use, or go to Step 4.

4 Configuring Your Recorder -- Continued

I. CONTROL 1 and CONTROL 2 Configuration -- Continued

4. Press [FUNC] key to call up next parameter and enter present selection.

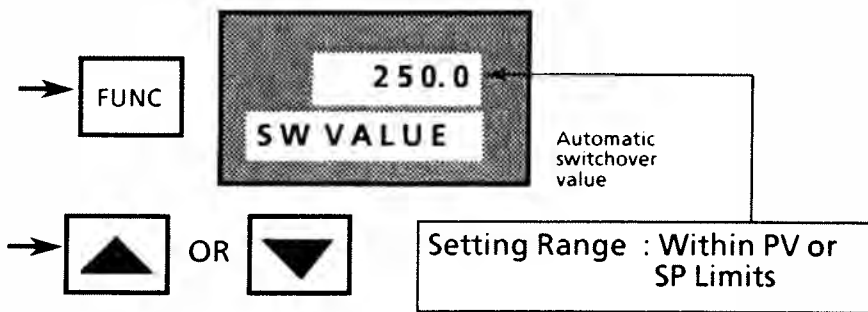

5. Use [RAISE] or [LOWER] key to set desired PV or SP switchover value, or go to Step 6.
6. Press [FUNC] key to call up next parameter and enter present selection.

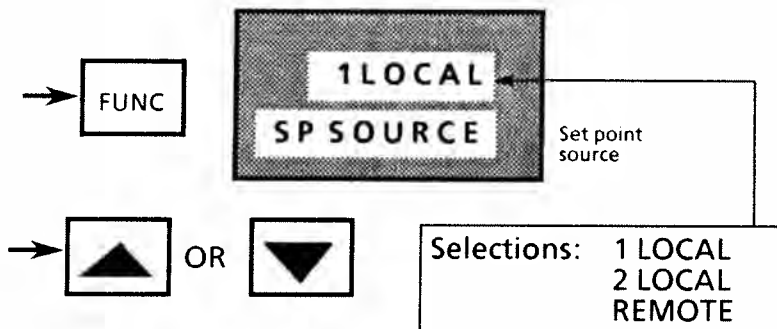

REMARKS
See Appendix A for details.

7. Use [RAISE] or [LOWER] key to select source of set point for control.
 - If you select REMOTE, go to Step 8; otherwise, go to Step 16.
 - If you select REMOTE, input #3 is automatically assigned as your RSP source for control #1; input #4 is assigned for control #2.
 - To select SP1 or SP2, use the 'FUNC' key to switch between the two SP's only after lower display shows the SP value.

4 Configuring Your Recorder – Continued

I. CONTROL 1 and CONTROL 2 Configuration -- Continued

8. Press [FUNC] key to call up next parameter and enter present selection.

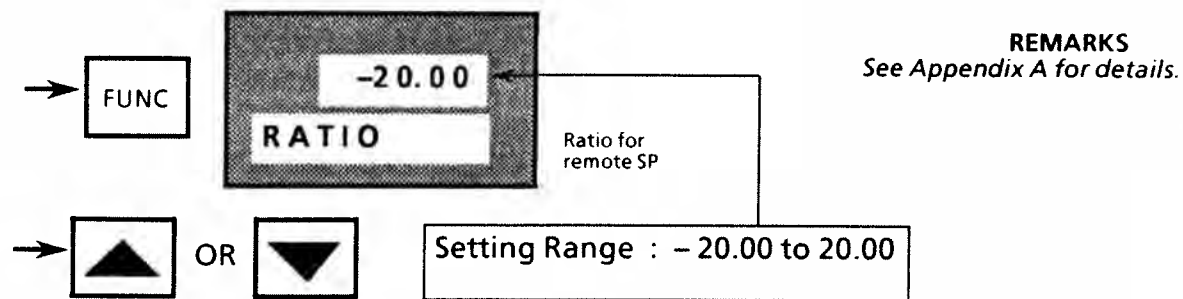

9. Use [RAISE] or [LOWER] key to set desired ratio value, or go to Step 10.

NOTE: If display blinks, you are trying to select an unacceptable value. You can change value more quickly by holding in one key [RAISE] or [LOWER] and pressing other one [LOWER] or [RAISE] at same time. Adjustment will move one digit to the left with each press.

10. Press [FUNC] key to call up next parameter and enter present selection.

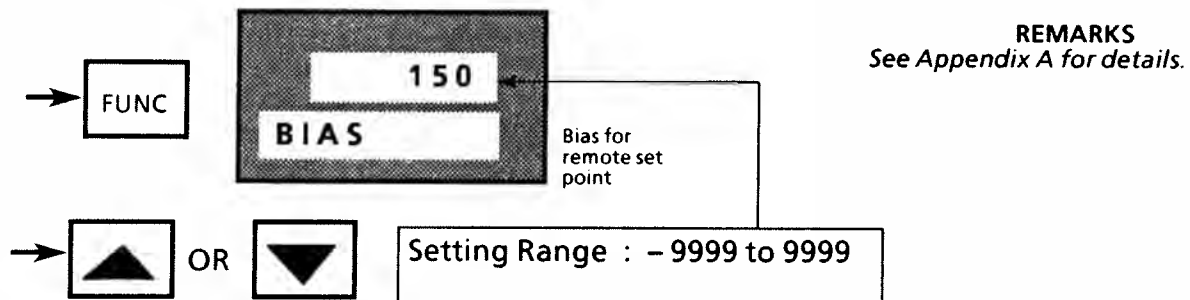

11. Use [RAISE] or [LOWER] key to set desired ratio value, or go to Step 12.

4 Configuring Your Recorder -- Continued

I. CONTROL 1 and CONTROL 2 Configuration -- Continued

12. Press [FUNC] key to call up next parameter and enter present selection.

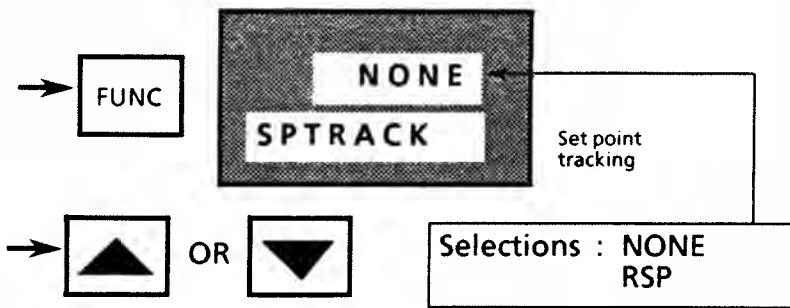

REMARKS
See Appendix A for details.

13. Use [RAISE] or [LOWER] key to select remote set point tracking, or go to Step 14.

14. Press [FUNC] key to call up next parameter and enter present selection.

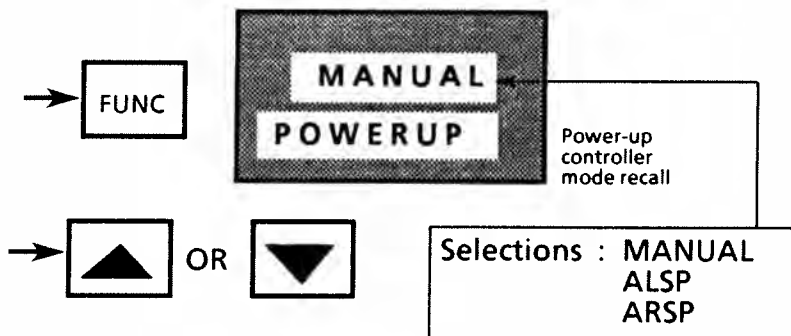

REMARKS
See Appendix A for details.

15. Use [RAISE] or [LOWER] key to select mode controller should return to after a power interruption, or go to Step 16.

4 Configuring Your Recorder – Continued

I. CONTROL 1 and CONTROL 2 Configuration -- Continued

16. Press [FUNC] key to call up next parameter and enter present selection.

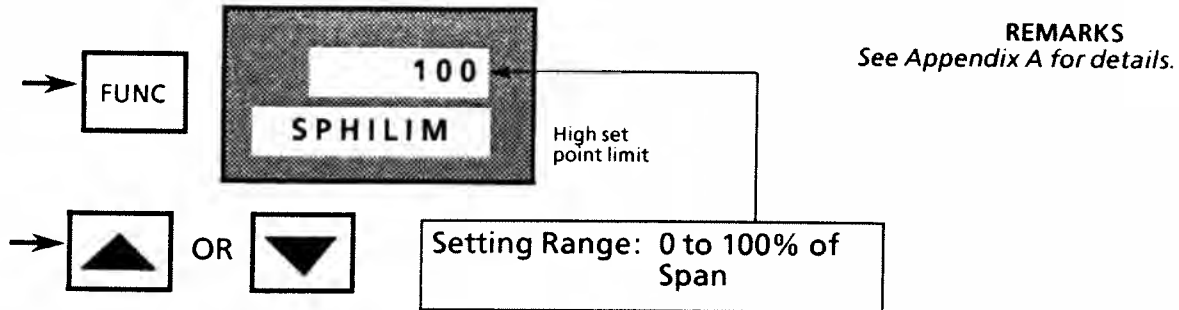

17. Use [RAISE] or [LOWER] key to set desired value, or go to Step 18.

NOTE: If display blinks, you are trying to select an unacceptable value. You can change value more quickly by holding in one key [RAISE] or [LOWER] and pressing other one [LOWER] or [RAISE] at same time. Adjustment will move one digit to the left with each press.

18. Press [FUNC] key to call up next parameter and enter present selection.

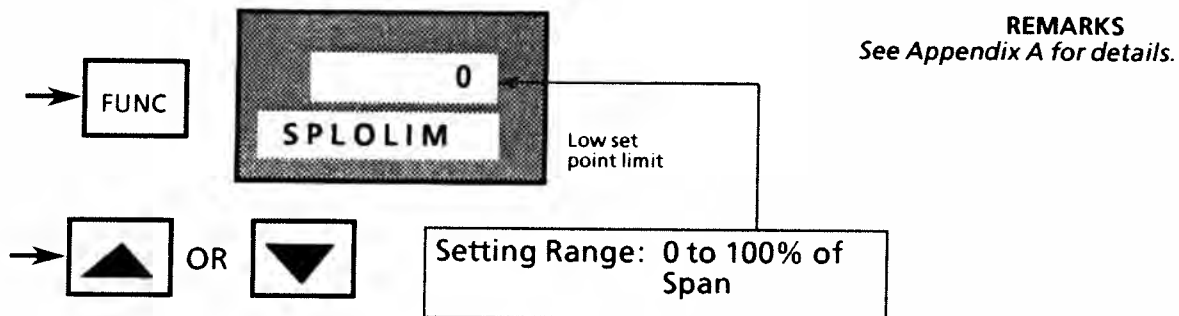

19. Use [RAISE] or [LOWER] key to set desired value, or go to Step 20.

4 Configuring Your Recorder -- Continued

I. CONTROL 1 and CONTROL 2 Configuration -- Continued

20. Press [FUNC] key to call up next parameter and enter present selection.

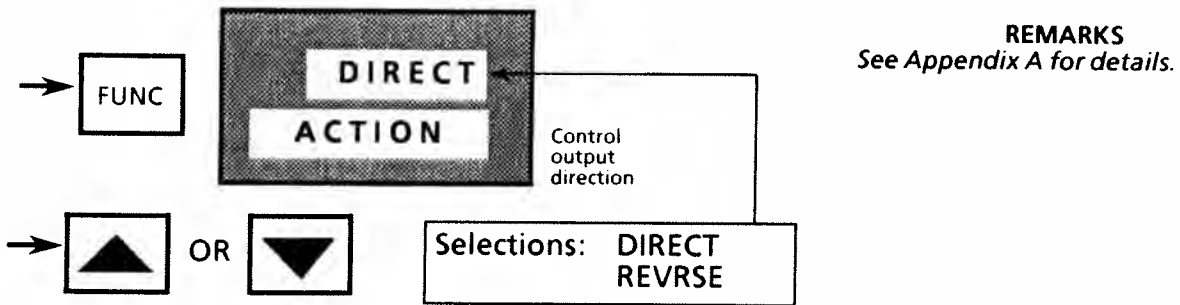

21. Use [RAISE] or [LOWER] key to select direct or reverse control action, or go to Step 22.

22. Press [FUNC] key to call up next parameter and enter present selection.

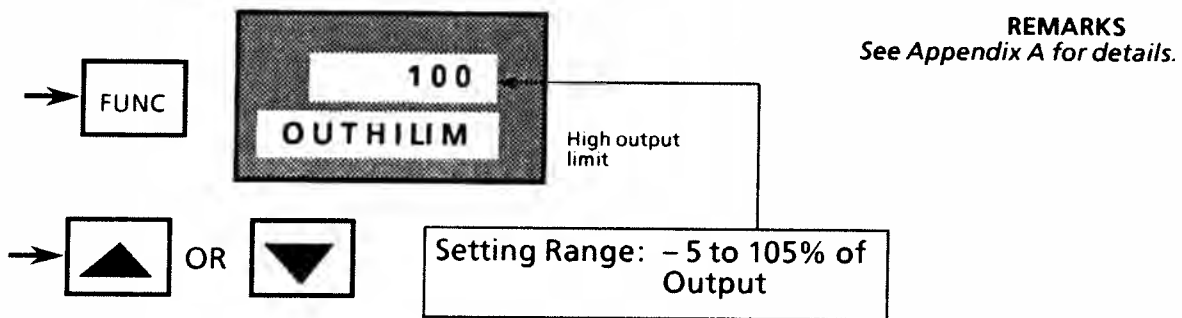

23. Use [RAISE] or [LOWER] key to set desired value, or go to Step 24.

4 Configuring Your Recorder -- Continued

I. CONTROL 1 and CONTROL 2 Configuration -- Continued

24. Press [FUNC] key to call up next parameter and enter present selection.

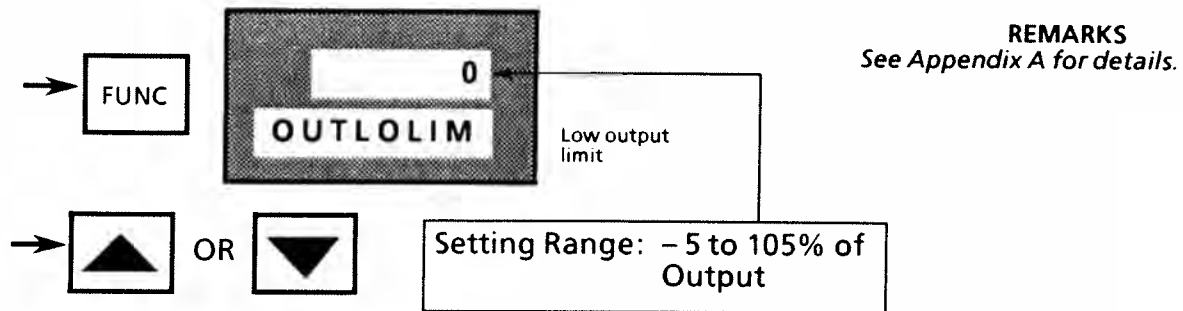

4

25. Use [RAISE] or [LOWER] key to select desired value, or go to Step 26.

26. Press [FUNC] key to call up next parameter and enter present selection.

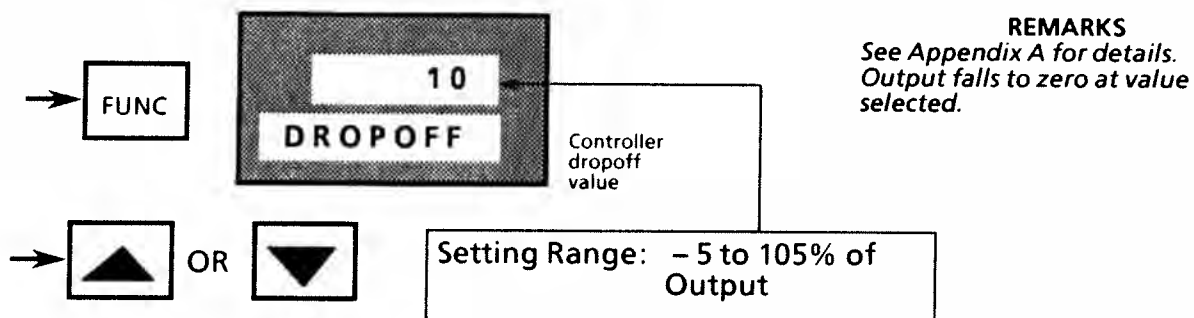

27. Use [RAISE] or [LOWER] key to set desired value, or go to Step 28.

4 Configuring Your Recorder -- Continued

I. CONTROL 1 and CONTROL 2 Configuration -- Continued

28. Press [FUNC] key to call up next parameter and enter present selection.

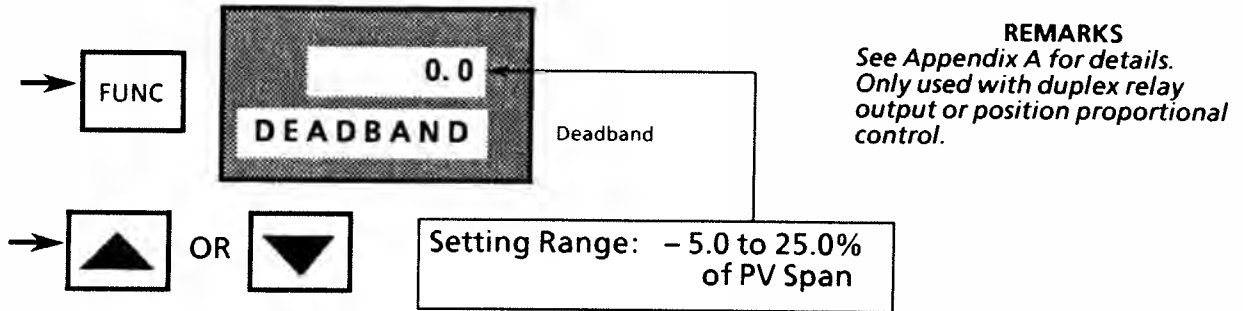

29. Use [RAISE] or [LOWER] key to select desired value , or go to Step 30.

30. Press [FUNC] key to call up next parameter and enter present selection.

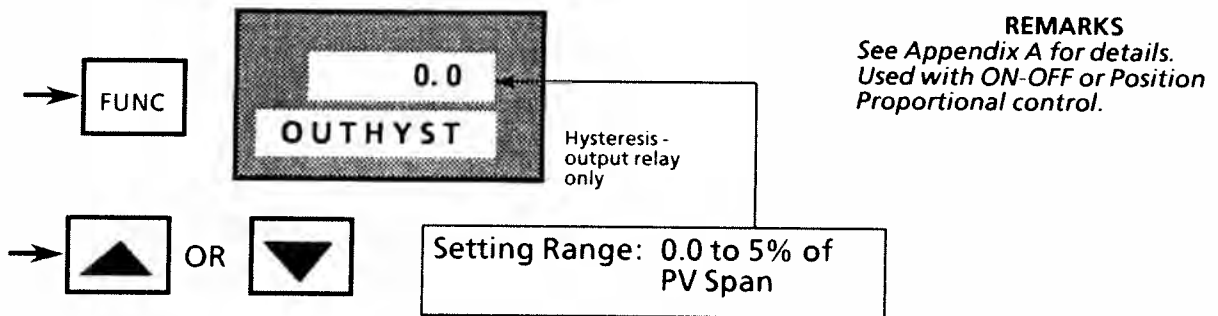

31. Use [RAISE] or [LOWER] key to set desired value, or go to Step 32.

4 Configuring Your Recorder -- Continued

I. CONTROL 1 and CONTROL 2 Configuration -- Continued

32. Press [FUNC] key to call up next parameter and enter present selection.

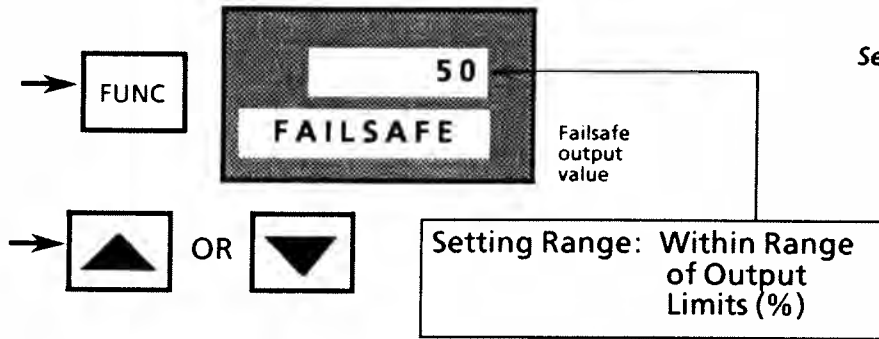

4

33. Use [RAISE] or [LOWER] key to select desired value , or go to Step 34.

34. Press [FUNC] key to call up next parameter and enter present selection.

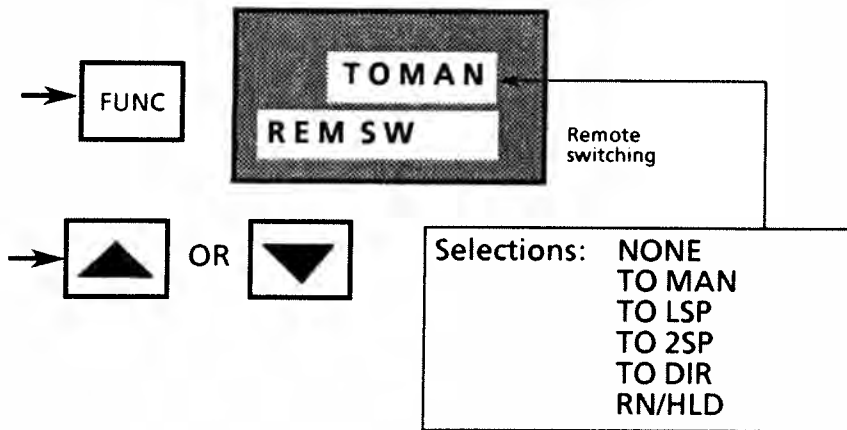

35. Use [RAISE] or [LOWER] key to select action to be initiated by remote contact closure -- switch controller to manual mode, to local set point, to 2nd set point, to direct output action, or put ramp/soak program in RUN; or go to Step 36.

4 Configuring Your Recorder -- Continued

I. CONTROL 1 and CONTROL 2 Configuration -- Continued

36. Press [FUNC] key to call up next parameter and enter present selection.

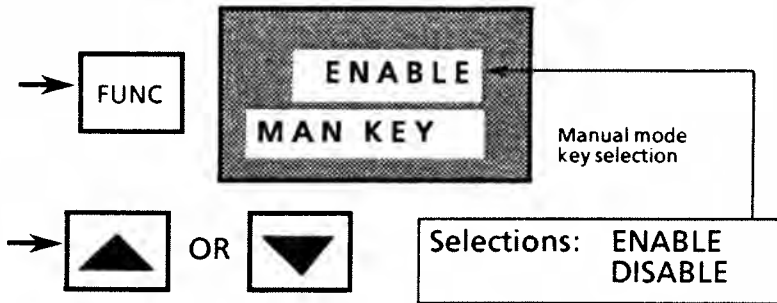

37. Use [RAISE] or [LOWER] key to enable or disable controller manual mode selection through [MAN/AUTO] key on recorder's keypad, or go to Step 38.

38. Press [FUNC] key to call up next parameter and enter present selection.

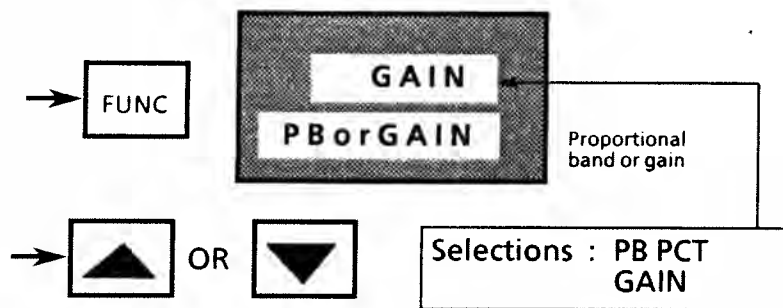

REMARKS
See Appendix A for details.

39. Use [RAISE] or [LOWER] key to select PROP BD or GAIN for TUNING 1 (TUNING 2) group, or go to Step 40.

4 Configuring Your Recorder -- Continued

I. CONTROL 1 and CONTROL 2 Configuration -- Continued

40. Press [FUNC] key to call up next parameter and enter present selection.

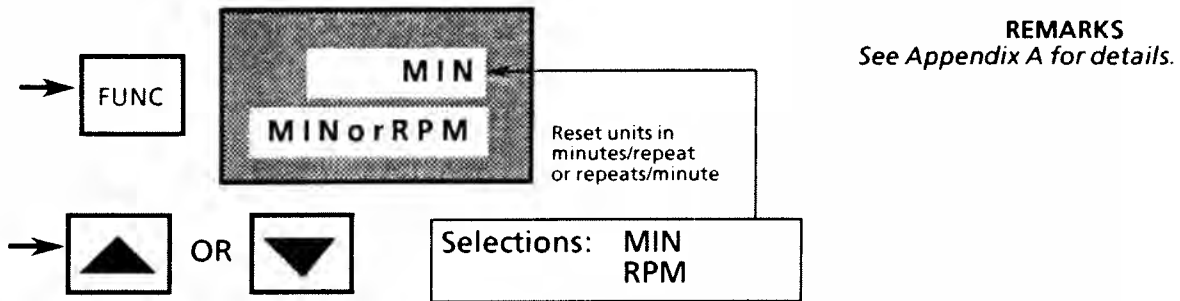

41. Use [RAISE] or [LOWER] key to select MIN or RPM for TUNING 1 (TUNING2), or go to Step 42.

42. Press [FUNC] key to call up next parameter and enter present selection.

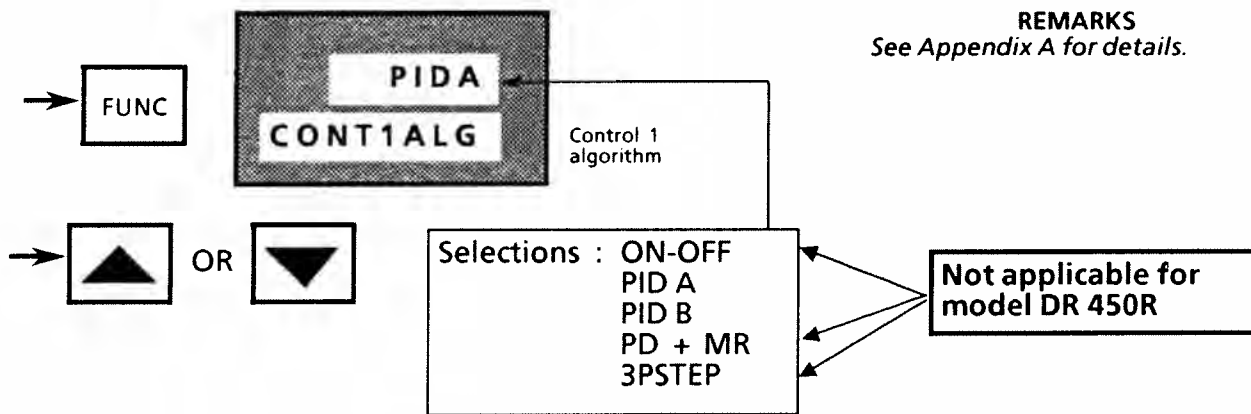

43. Use [RAISE] or [LOWER] key to select desired algorithm for control output #1 or go to Step 44.

NOTE: To recall original value or selection, press [RUN/HOLD] (or [] blank) key before pressing [FUNC] key again.

4 Configuring Your Recorder – Continued

I. CONTROL 1 and CONTROL 2 Configuration

44. Press [FUNC] key to call up next parameter and enter present selection.

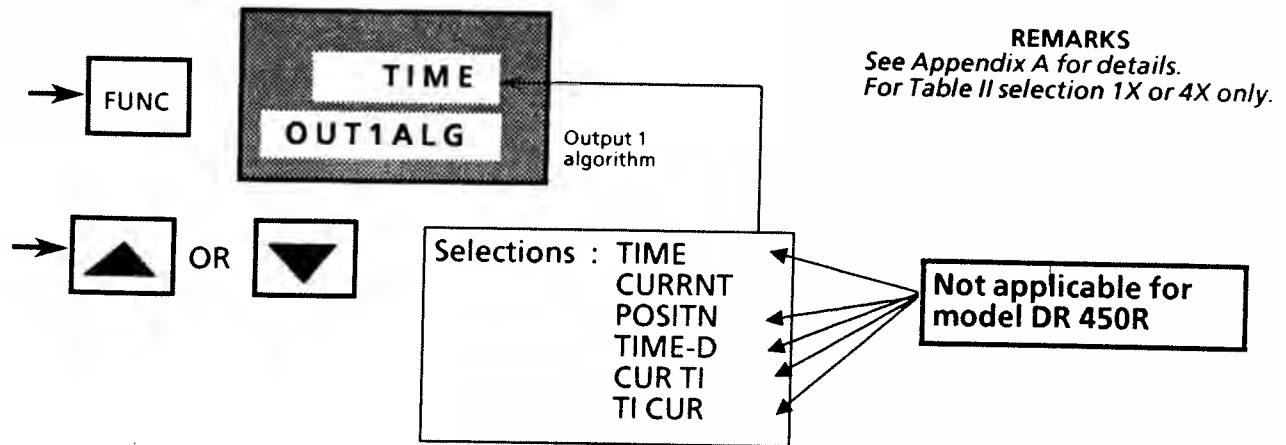

45. Use [RAISE] or [LOWER] key to select output algorithm for control output #1.
 • If you select CUR TI or TI CUR, go to Step 46; otherwise, go to Step 48.

46. Press [FUNC] key to call up next parameter and enter present selection.

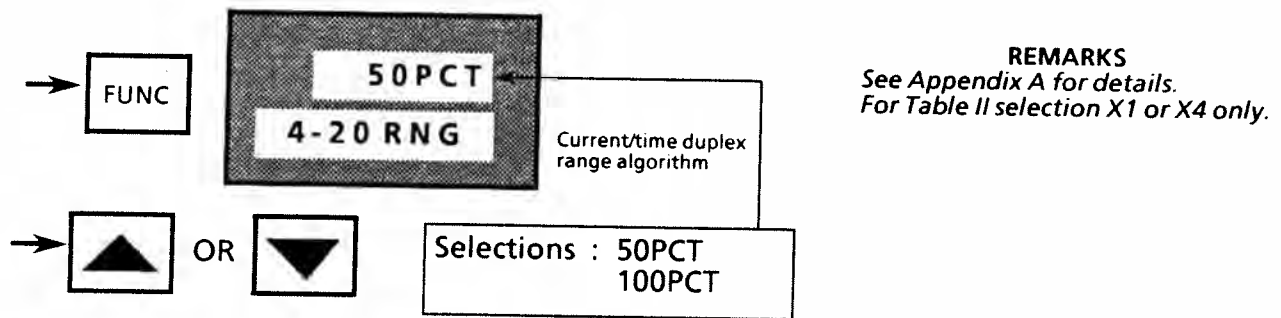

47. Use [RAISE] or [LOWER] key to select Split (50PCT) or full (100PCT) current for duplex range, or go to Step 48.

4 Configuring Your Recorder – Continued

I. CONTROL 1 and CONTROL 2 Configuration -- Continued

48. Press [FUNC] key to call up next parameter and enter present selection.

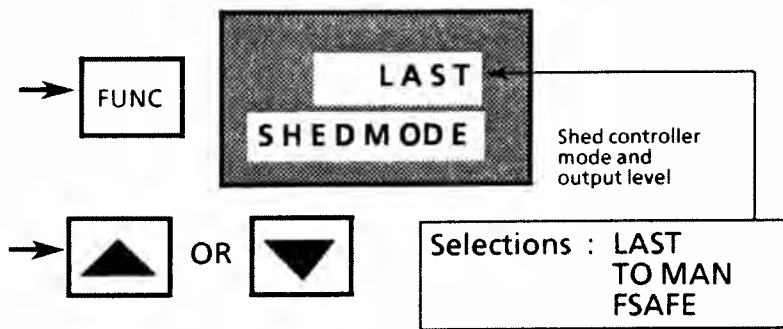

REMARKS
 For DMCS communications only -
 Key Number = DR 450T and Table
 III = 1XX per Model Number.

4

49. Use [RAISE] or [LOWER] key to select if you want controller to remain in same mode with output at same level, switch to manual mode with bumpless output, or switch to manual with failsafe output level when recorder sheds communications, or go to Step 50.

50. Press [FUNC] key to call up next parameter and enter present selection.

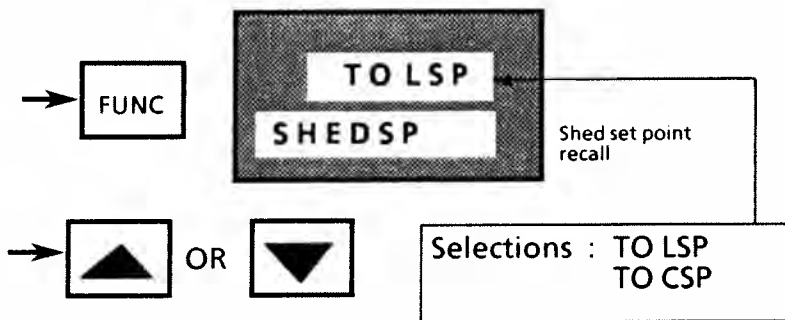

REMARKS
 For DMCS communications only -
 Key Number = DR 450T and Table
 III = 1XX per Model Number.

51. Use [RAISE] or [LOWER] key to select if you want set point to be local set point value, or last computer set point when recorder sheds communications, or go to Step 52.

52. Press [SET UP] key to call up next group prompt and go to appropriate procedure in this section. Or, press [LOWR DISP] key to exit Configuration Mode.

REPEAT PROCEDURE FOR CONTROL 2 CONFIGURATION

4 Configuring Your Recorder -- Continued

J. OPTIONS Configuration

Prerequisites:

- Recorder door is open and power is ON.
- Keypad LOCKOUT configuration is NONE.

1. Press [SET UP] key to put recorder in Configuration (SET UP) Mode and call up OPTIONS prompt in lower display. If recorder is in SET UP Mode, successively press [SET UP] key to step through group prompts or hold key in to scroll prompts until OPTIONS appears in display.



REMARKS
 If you want to abort (exit) configuration, press [LOWR DISP] key or don't press any key for 1 minute.

2. Press [FUNC] key to call up first options parameter for configuration.

NOTE: Hold key in if you want to scroll through all the function prompts associated with this group.

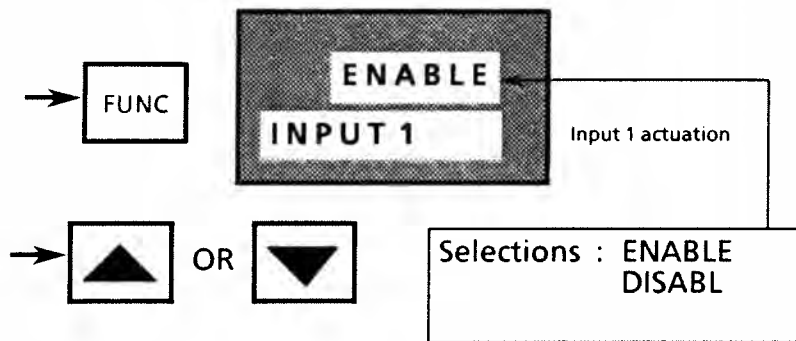

3. Use [RAISE] or [LOWER] key to enable or disable input 1, or go to Step 4.

NOTE: To recall original value or selection, press [RUN/HOLD] key before pressing [FUNC] key again.

4 Configuring Your Recorder – Continued

J. OPTIONS Configuration

4. Press [FUNC] key to call up next parameter and enter present selection.

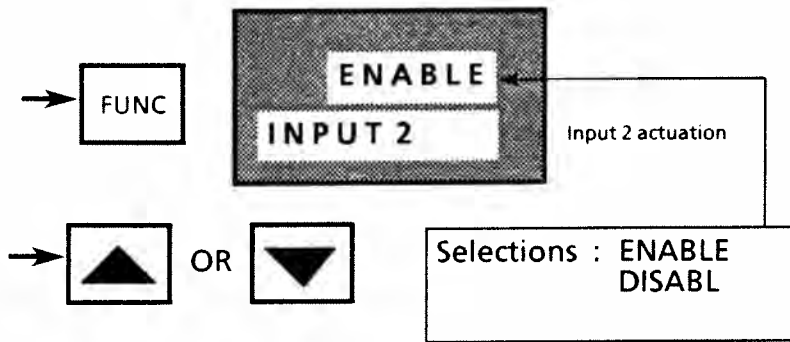

5. Use [RAISE] or [LOWER] key to enable or disable input 2, or go to Step 6.

6. Press [FUNC] key to call up next parameter and enter present selection.

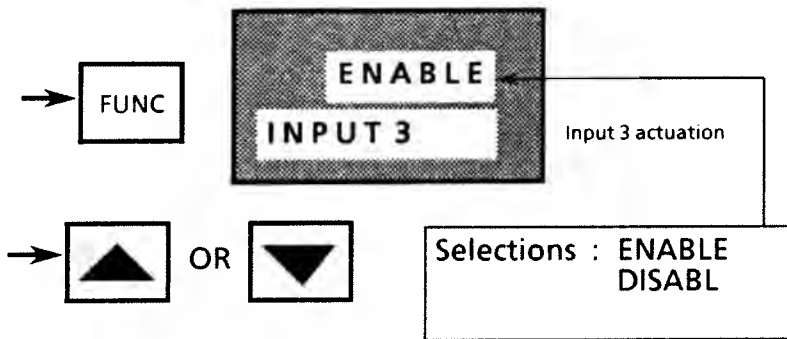

7. Use [RAISE] or [LOWER] key to enable or disable input 3, or go to Step 8.

4 Configuring Your Recorder – Continued

J. OPTIONS Configuration

8. Press [FUNC] key to call up next parameter and enter present selection.

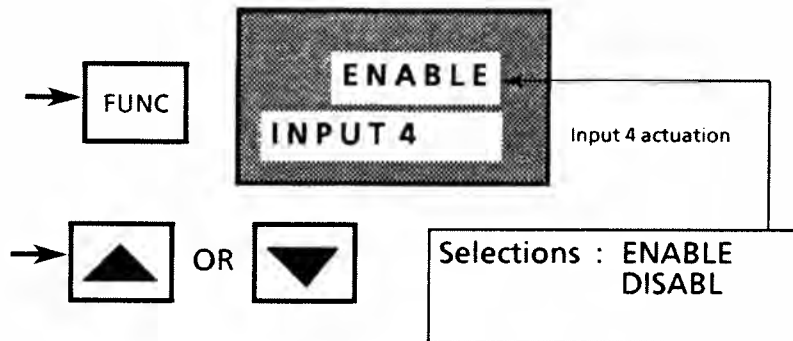

9. Use [RAISE] or [LOWER] key to enable or disable input 4, or go to Step 10.

10. Press [FUNC] key to call up next parameter and enter present selection.

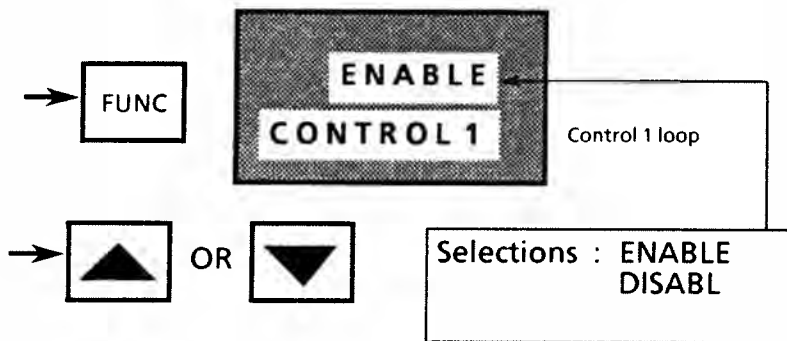

11. Use [RAISE] or [LOWER] key to enable or disable control loop #1, or go to Step 12.

4 Configuring Your Recorder – Continued

J. OPTIONS Configuration

12. Press [FUNC] key to call up next parameter and enter present selection.

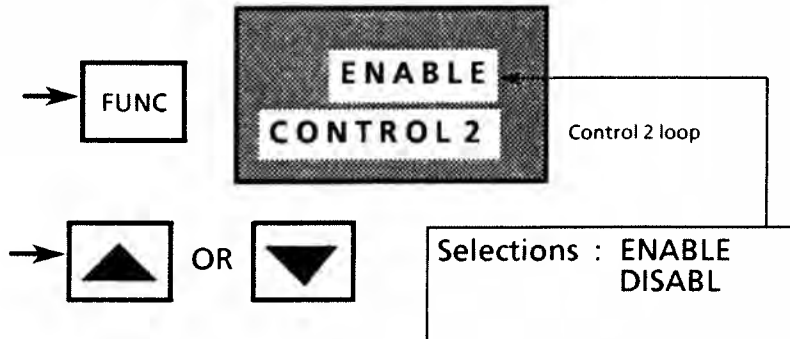

13. Use [RAISE] or [LOWER] key to enable or disable control loop #2, or go to Step 14.

14. Press [FUNC] key to call up next parameter and enter present selection.

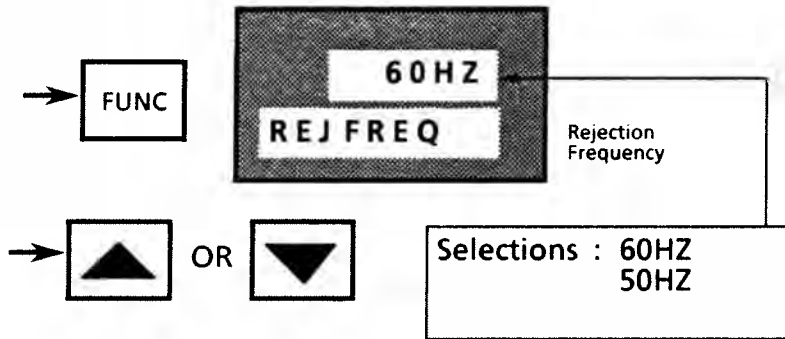

REMARKS
Be sure selection agrees with line voltage frequency.

15. Use [RAISE] or [LOWER] key to select correct rejection frequency, or go to Step 16.

4 Configuring Your Recorder -- Continued

J. OPTIONS Configuration -- Continued

16. Press [FUNC] key to call up next parameter and enter present selection.

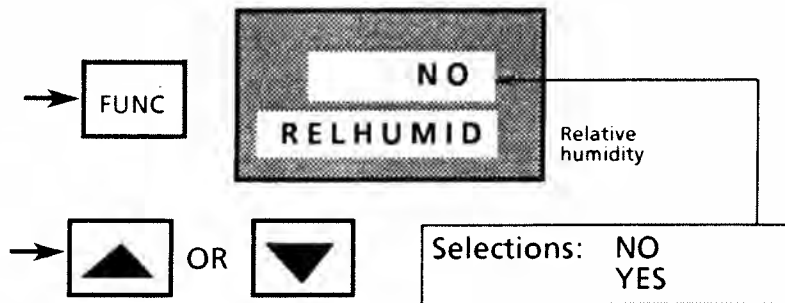

REMARKS
 Must select 100 RH type for two inputs to measure RH. Requires two 100 ohm RTD inputs so INPUT 2 must be enabled for this prompt to appear. Also, must select RH for PEN2IN which represents the "wet bulb" temperature.

17. Use [RAISE] or [LOWER] key to activate or deactivate RH calculation algorithm.
 • If you select YES, go to Step 18; otherwise, go to Step 20.

18. Press [FUNC] key to call up next parameter and enter present selection.

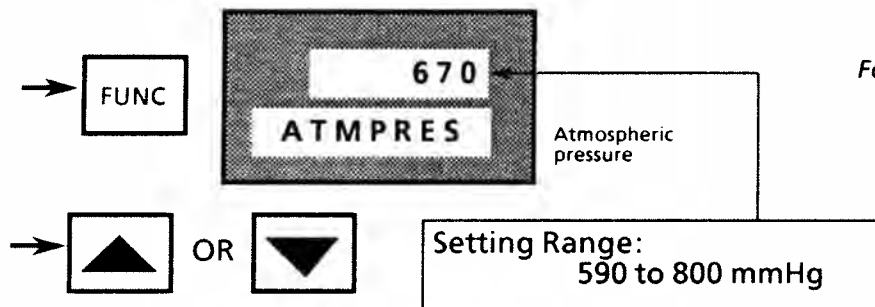

REMARKS
 For RH measurement only.

19. Use [RAISE] or [LOWER] key to set desired atmospheric pressure compensation or go to Step 20.

NOTE: If display blinks, you are trying to select an unacceptable value. You can change value more quickly by holding in one key [RAISE] or [LOWER] and pressing other one [LOWER] or [RAISE] at same time. Adjustment will move one digit to the left with each press.

4 Configuring Your Recorder -- Continued

J. OPTIONS Configuration -- Continued

NOTE: If Key Number = DR 450R, Table II = 40, and Table III = 003 per model number; see Appendix D for F_0 calculation prompts that will appear here.

20. Press [FUNC] key to call up next parameter and enter present selection.

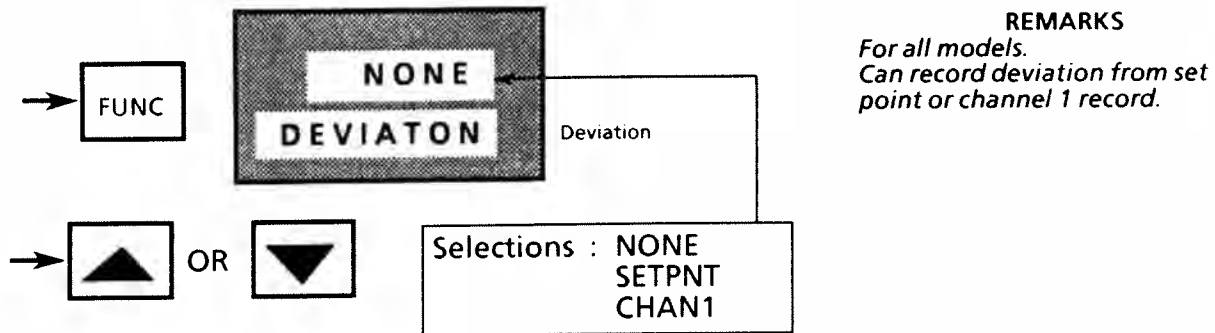

21. Use [RAISE] or [LOWER] key to select deviation recording action, if desired.
 • If you select SETPNT, go to Step 22; otherwise, go to Step 24.

22. Press [FUNC] key to call up next parameter and enter present selection.

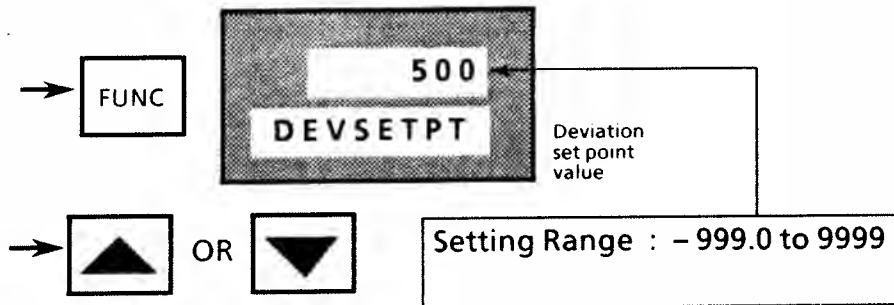

23. Use [RAISE] or [LOWER] key to set desired deviation set point for deviation recording or go to Step 24.

NOTE: If display blinks, you are trying to select an unacceptable value. You can change value more quickly by holding in one key [RAISE] or [LOWER] and pressing other one [LOWER] or [RAISE] at same time. Adjustment will move one digit to the left with each press.

4 Configuring Your Recorder – Continued

J. OPTIONS Configuration -- Continued

24. Press [FUNC] key to call up next parameter and enter present selection.

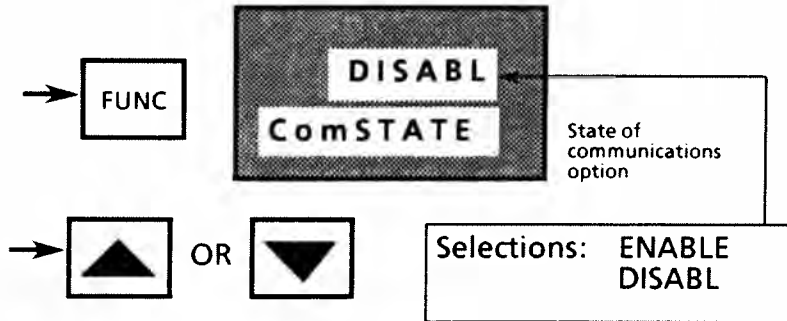

REMARKS
 For DMCS communications only -
 Key Number = DR 450T and Table
 III = 1XX per model number.

25. Use [RAISE] or [LOWER] key to enable or disable communications function.
 • If you select DISABL, go to Step 32; otherwise, go to Step 26.

26. Press [FUNC] key to call up next parameter and enter present selection.

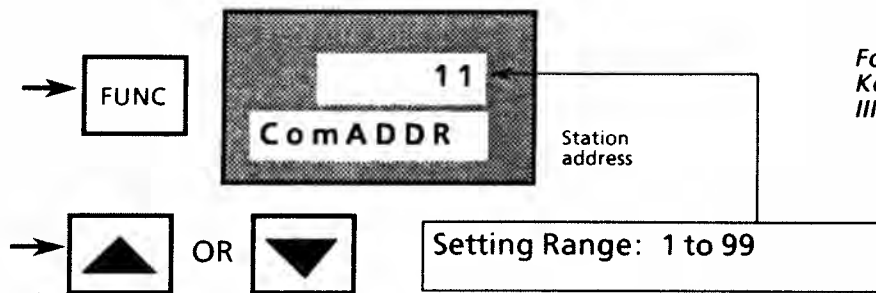

REMARKS
 For DMCS communications only -
 Key Number = DR 450T and Table
 III = 1XX per model number.

27. Use [RAISE] or [LOWER] key to set desired station address for recorder in communications link, or go to Step 28.

4 Configuring Your Recorder – Continued

J. OPTIONS Configuration -- Continued

28. Press [FUNC] key to call up next parameter and enter present selection.

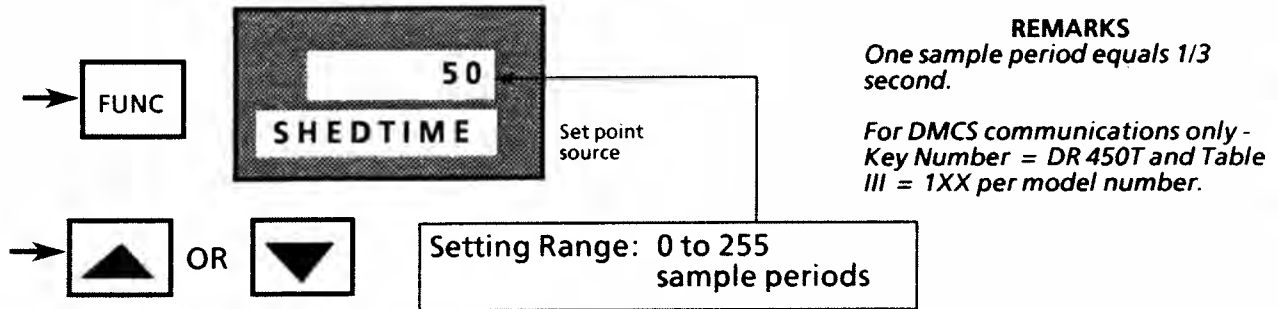

29. Use [RAISE] or [LOWER] key to set desired shed time, or go to Step 30.

30. Press [FUNC] key to call up next parameter and enter present selection.

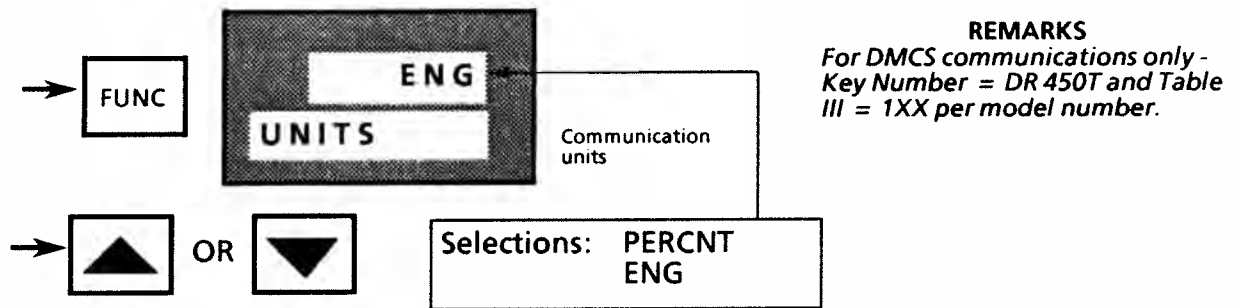

31. Use [RAISE] or [LOWER] key to select if you want units to be transmitted in percent or engineering units , or go to Step 32.

32. Press [SET UP] key to call up next group prompt and go to appropriate procedure in this section. Or, press [LOWR DISP] key to exit Configuration Mode.

4 Configuring Your Recorder -- Continued

K. ALARMS Configuration

NOTE: If Key Number = DR 450R per model number, see Appendix D for Alarms configuration.

Prerequisites:

- Table III = XX1 per Model Number
- Recorder door is open and power is ON.
- Keypad LOCKOUT configuration is NONE.

1. Press [SET UP] key to put recorder in Configuration (SET UP) Mode and call up ALARMS prompt in lower display. If recorder is in SET UP Mode, successively press [SET UP] key to step through group prompts or hold key in to scroll prompts until ALARMS appears in display.



REMARKS
 If you want to abort (exit) configuration mode, press [LOWR DISP] key or don't press any key for 1 minute.

2. Press [FUNC] key to call up first control parameter for configuration.

NOTE: Hold key in if you want to scroll through all the function prompts associated with this group.

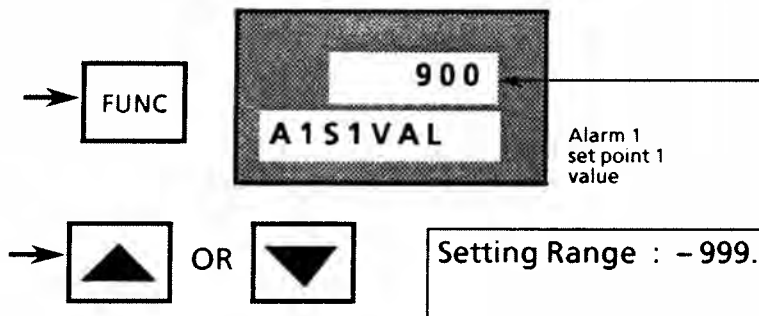

REMARKS
 See Step 6, Alarm Type:
 - Be sure value agrees with alarm type.
 - Note that value equals segment number for EV1 ON or EV1 OFF Type for controller #1 SP program.
 - Will not appear if type is NONE.

3. Use [RAISE] or [LOWER] key to set desired set point 1 value for alarm 1, or go to Step 4.

NOTE: If display blinks, you are trying to select an unacceptable value. You can change value more quickly by holding in one key [RAISE] or [LOWER] and pressing other one [LOWER] or [RAISE] at same time. Adjustment will move one digit to the left with each press.

4 Configuring Your Recorder – Continued

K. ALARMS Configuration -- Continued

NOTE: To recall original value or selection, press [RUN/HOLD] key before pressing [FUNC] key again.

4. Press [FUNC] key to call up next parameter and enter present selection.

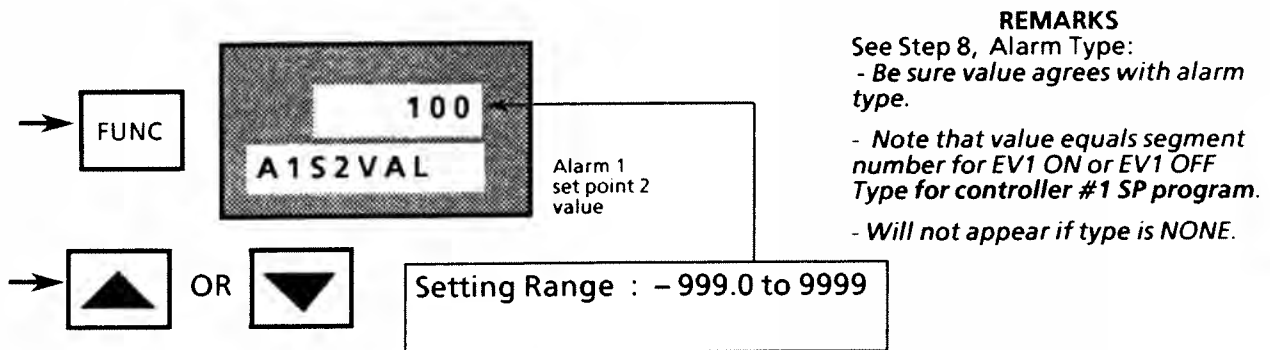

5. Use [RAISE] or [LOWER] key to set desired set point 2 value for alarm 1, or go to Step 6.
6. Press [FUNC] key to call up next parameter and enter present selection.

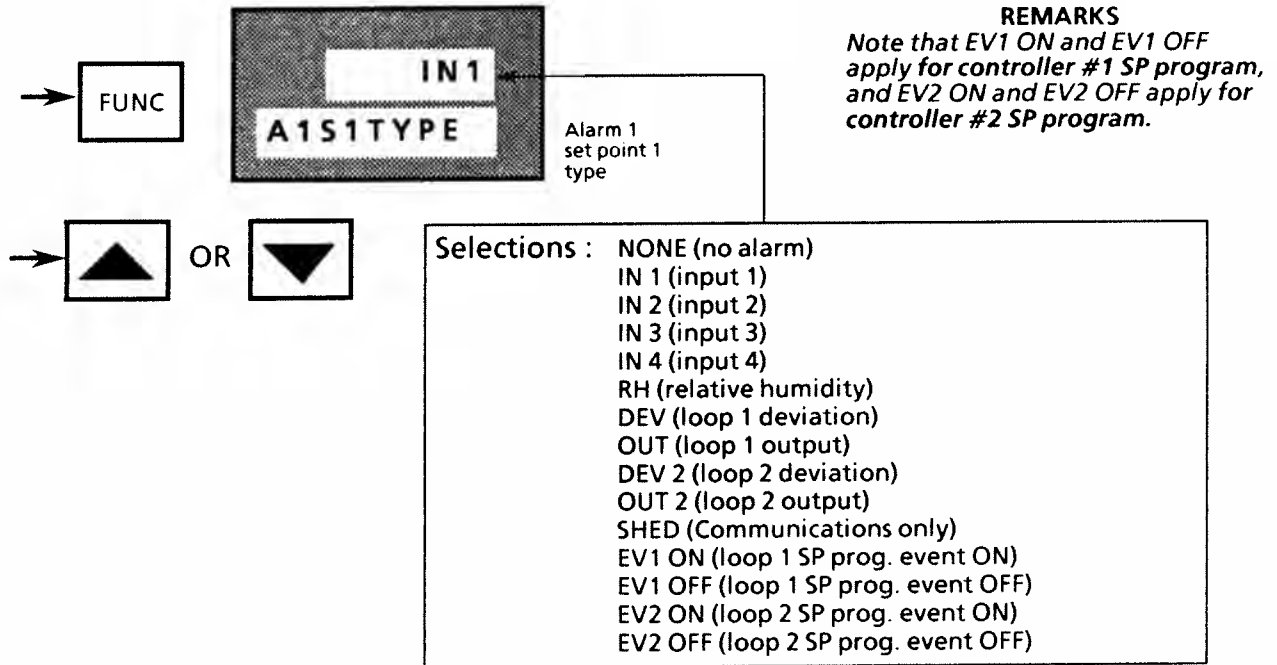

7. Use [RAISE] or [LOWER] key to select desired set point 1 alarm 1 type, or go to Step 8.
 Note that some selections may not appear, depending on your recorder model.

4 Configuring Your Recorder – Continued

K. ALARMS Configuration -- Continued

8. Press [FUNC] key to call up next parameter and enter present selection.

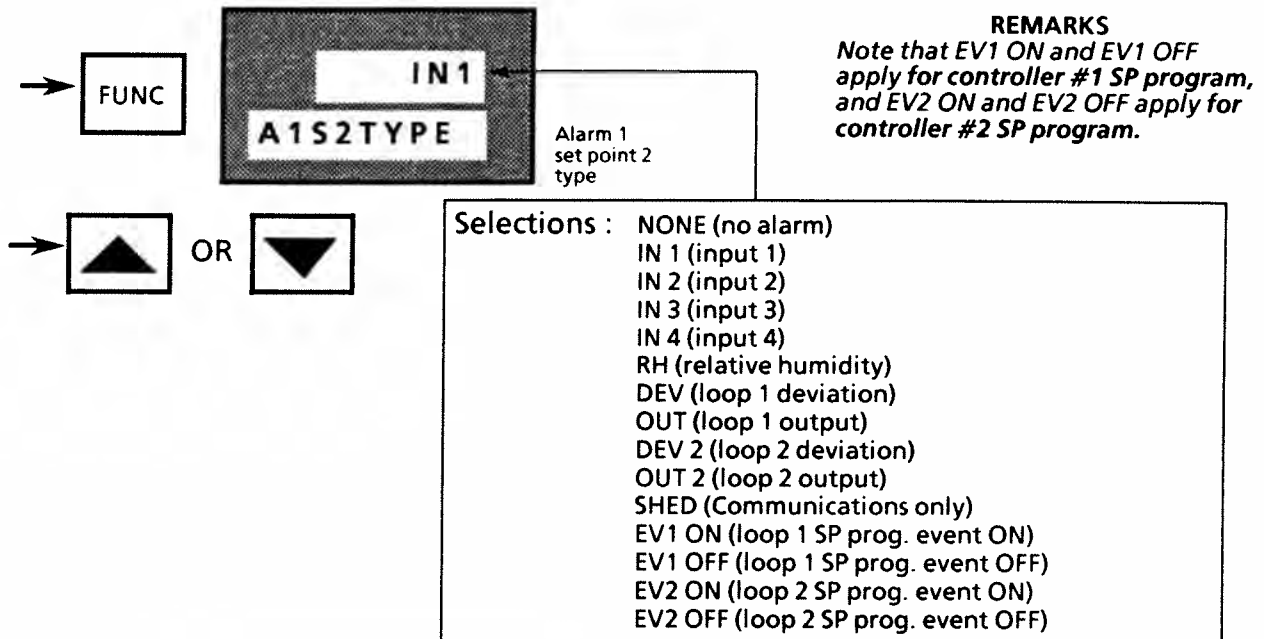

9. Use [RAISE] or [LOWER] key to select desired set point 2 alarm 1 type, or go to Step 10. Note that some selections may not appear, depending on your recorder model.

10. Press [FUNC] key to call up next parameter and enter present selection.

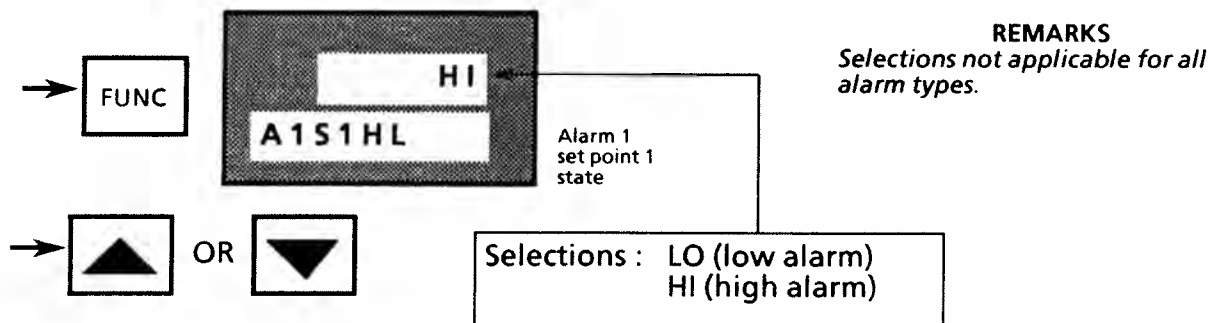

11. Use [RAISE] or [LOWER] key to select applicable set point 1 alarm 1 state, or go to Step 12.

4 Configuring Your Recorder – Continued

K. ALARMS Configuration -- Continued

12. Press [FUNC] key to call up next parameter and enter present selection.

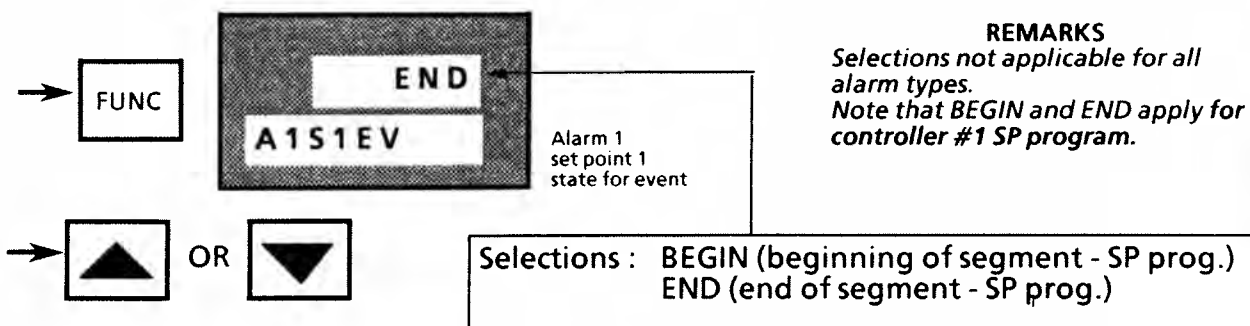

4

13. Use [RAISE] or [LOWER] key to select applicable set point 1 alarm 1 state for event, or go to Step 14.

14. Press [FUNC] key to call up next parameter and enter present selection.

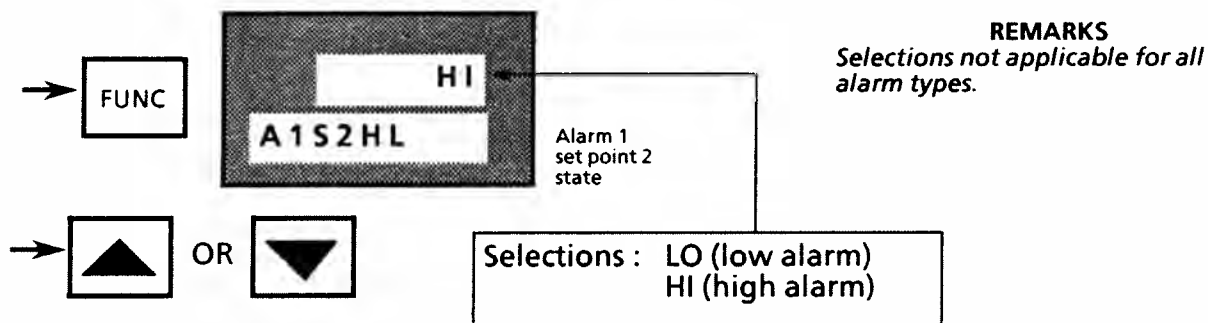

15. Use [RAISE] or [LOWER] key to select applicable set point 2 alarm 1 state, or go to Step 16.

4 Configuring Your Recorder -- Continued

K. ALARMS Configuration -- Continued

16. Press [FUNC] key to call up next parameter and enter present selection.

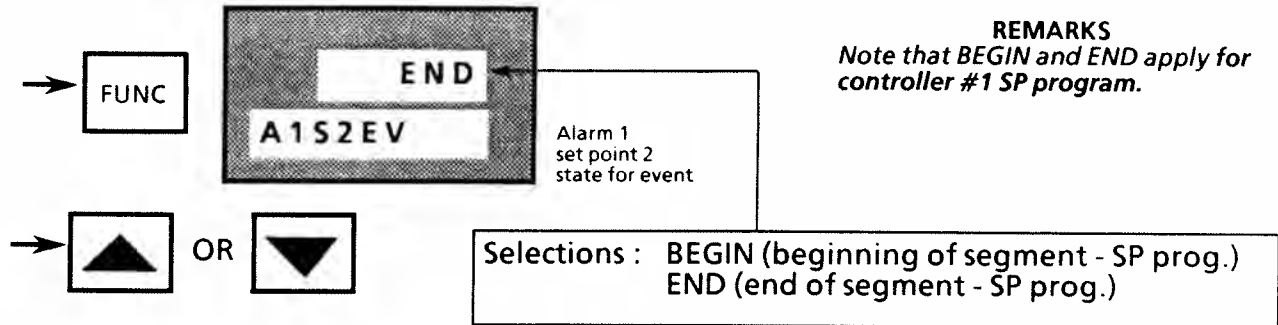

17. Use [RAISE] or [LOWER] key to select applicable set point 2 alarm 1 state for event, or go to Step 18.

NOTE: To recall original value or selection, press [RUN/HOLD] key before pressing [FUNC] key again.

18. Press [FUNC] key to call up next parameter and enter present selection.

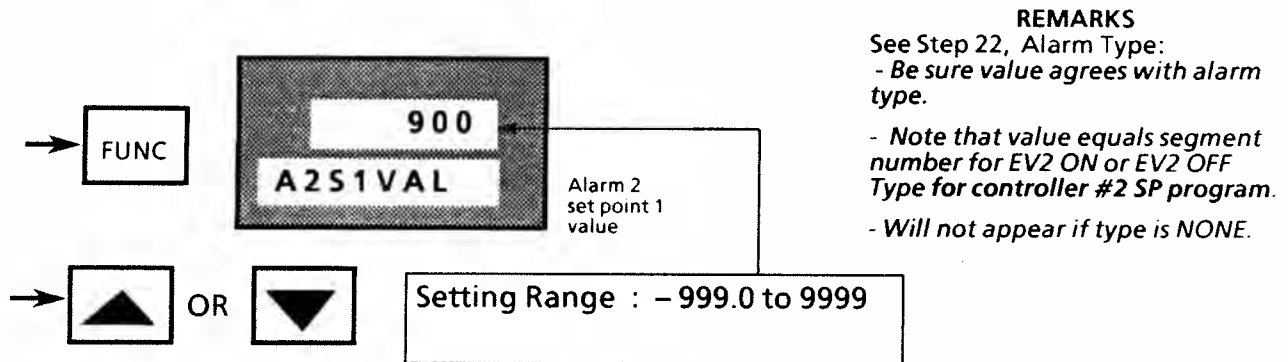

19. Use [RAISE] or [LOWER] key to set desired set point 1 for alarm 2, or go to Step 20.

4 Configuring Your Recorder – Continued

K. ALARMS Configuration -- Continued

20. Press [FUNC] key to call up next parameter and enter present selection.

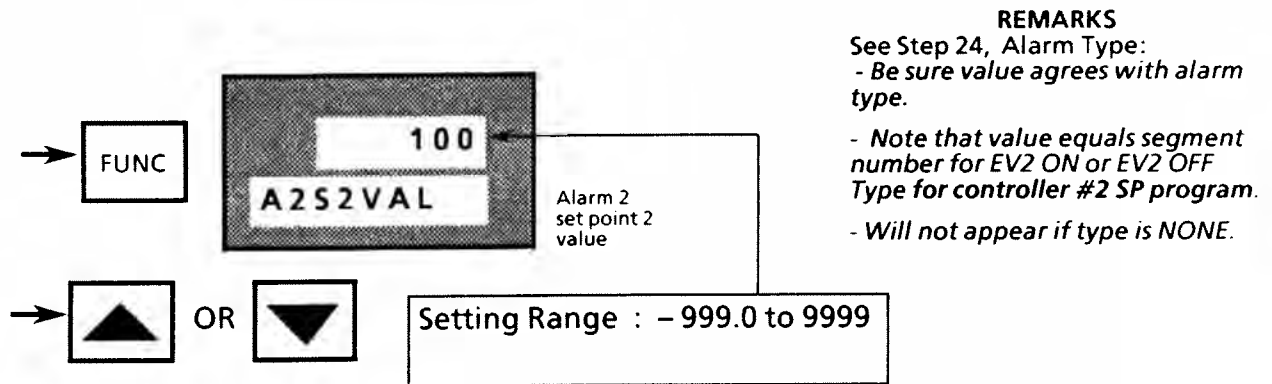

21. Use [RAISE] or [LOWER] key to set desired set point 2 value for alarm 2, or go to Step 22.

22. Press [FUNC] key to call up next parameter and enter present selection.

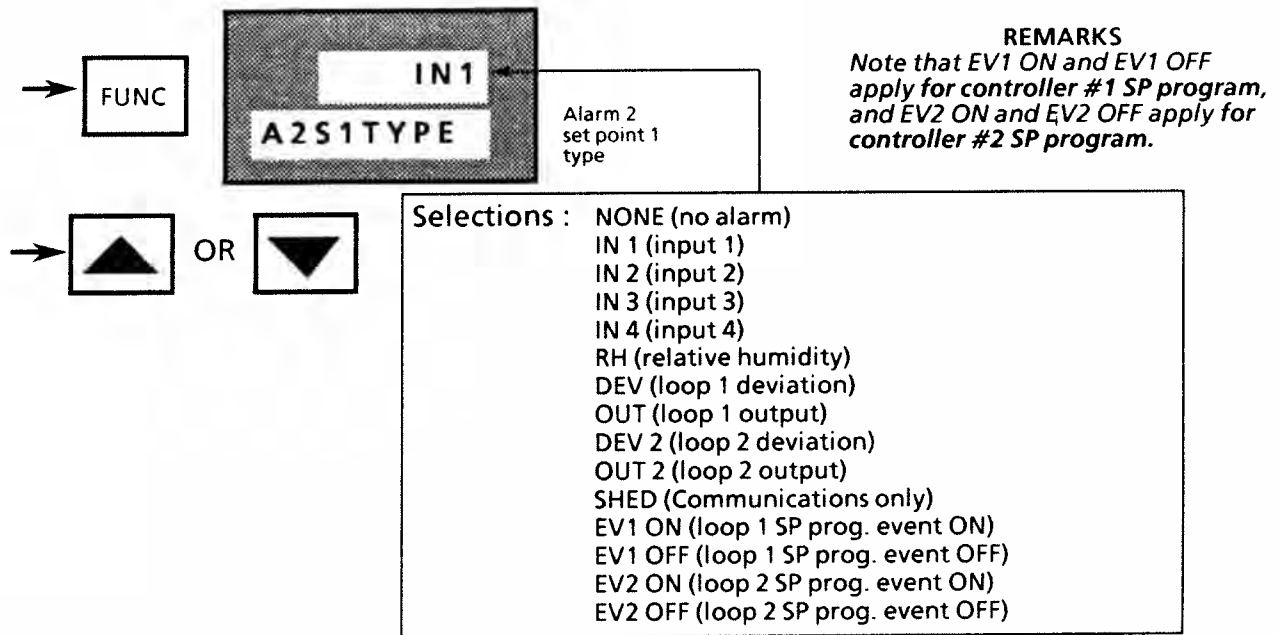

23. Use [RAISE] or [LOWER] key to select desired set point 1 alarm 2 type, or go to Step 24. Note that some selections may not appear, depending on your recorder model.

4 Configuring Your Recorder – Continued

K. ALARMS Configuration -- Continued

24. Press [FUNC] key to call up next parameter and enter present selection.

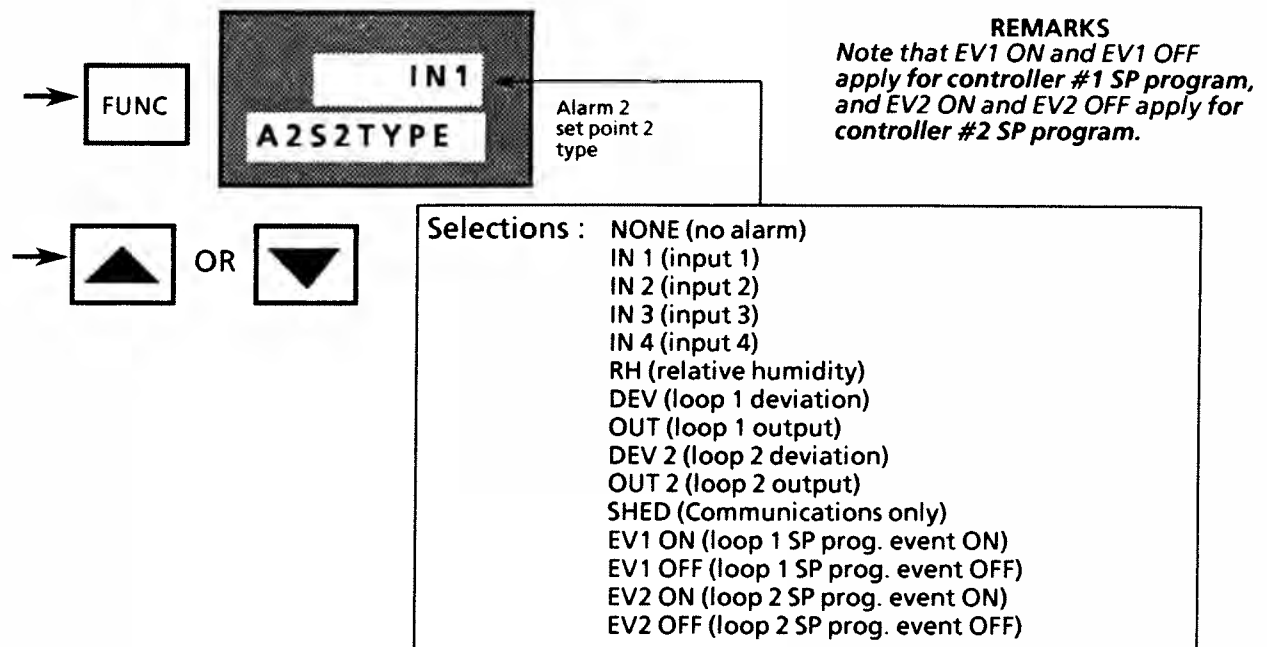

25. Use [RAISE] or [LOWER] key to select desired set point 1 alarm 2 type, or go to Step 26.
 Note that some selections may not appear, depending on your recorder model.

26. Press [FUNC] key to call up next parameter and enter present selection.

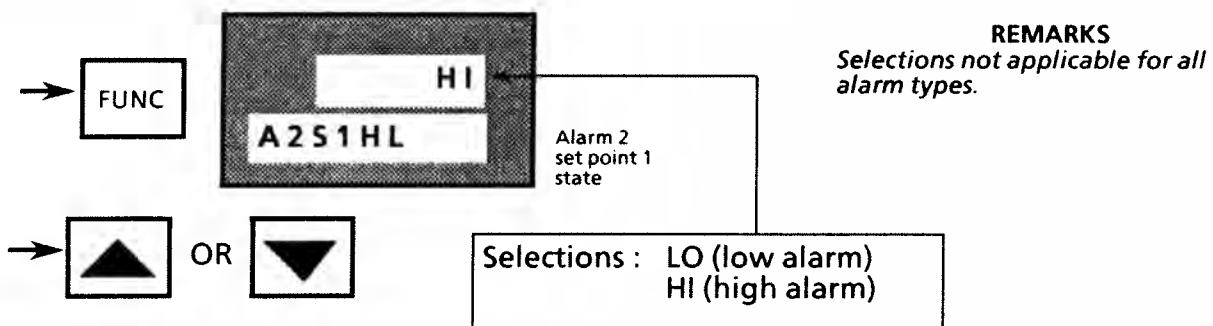

27. Use [RAISE] or [LOWER] key to select applicable set point 1 alarm 2 state, or go to Step 28.

4 Configuring Your Recorder -- Continued

K. ALARMS Configuration -- Continued

28. Press [FUNC] key to call up next parameter and enter present selection.

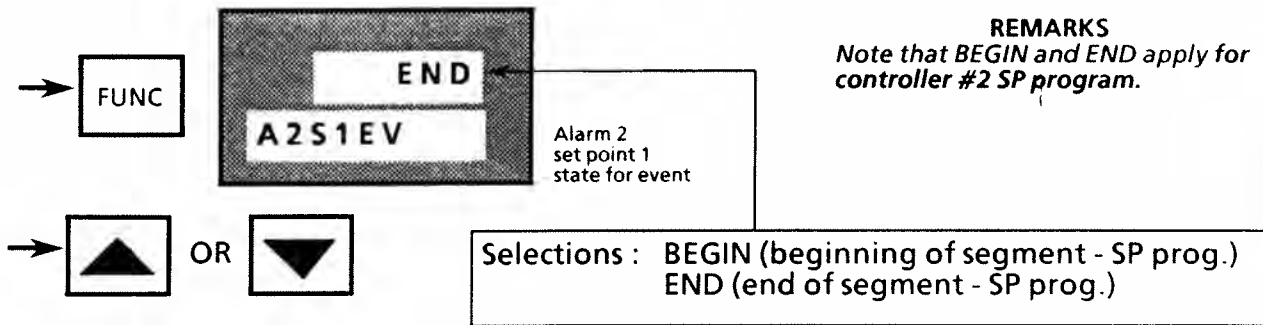

4

29. Use [RAISE] or [LOWER] key to select applicable set point 1 alarm 2 state for event, or go to Step 30.

30. Press [FUNC] key to call up next parameter and enter present selection.

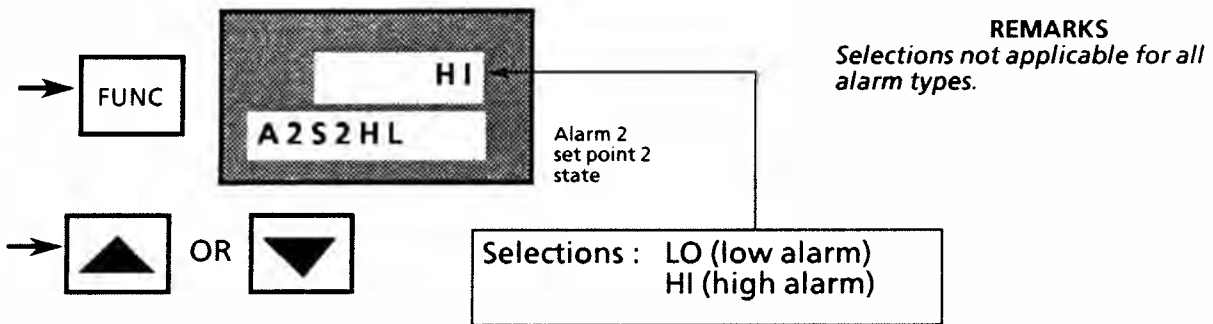

31. Use [RAISE] or [LOWER] key to select applicable set point 2 alarm 2 state, or go to Step 32.

4 Configuring Your Recorder – Continued

K. ALARMS Configuration -- Continued

32. Press [FUNC] key to call up next parameter and enter present selection.

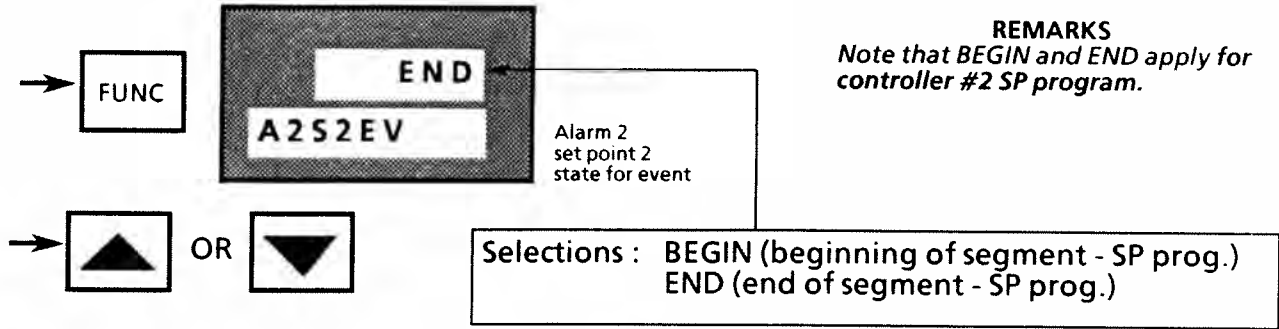

33. Use [RAISE] or [LOWER] key to select applicable set point 2 alarm 2 state for event, or go to Step 34.

34. Press [FUNC] key to call up next parameter and enter present selection.

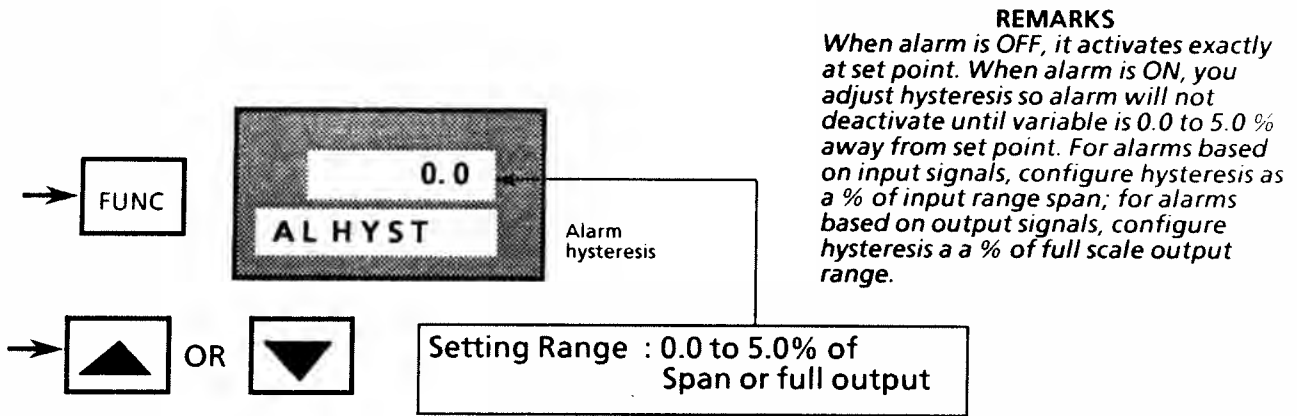

35. Use [RAISE] or [LOWER] key to set hysteresis for alarm 2 action, or go to Step 36.

36. Press [SET UP] key to call up next group prompt and go to appropriate procedure in this section. Or, press [LOWR DISP] key to exit Configuration Mode.

4 Configuring Your Recorder – Continued

L. LOCKOUT Configuration

Prerequisites:

- Available on all models
- Recorder door is open and power is ON.
- Must know PASSWORD to change LOCKOUT configuration.

1. Press [SET UP] key to put recorder in Configuration (SET UP) Mode and call up LOCKOUT prompt in lower display. If recorder is in SET UP Mode, successively press [SET UP] key to step through group prompts or hold key in to scroll prompts until LOCKOUT appears in display.



REMARKS
 If you want to abort (exit) configuration mode, press [LOWR DISP] key or don't press any key for 1 minute.

2. Press [FUNC] key to call up PASSWORD parameter to gain access to keypad lockout configuration.

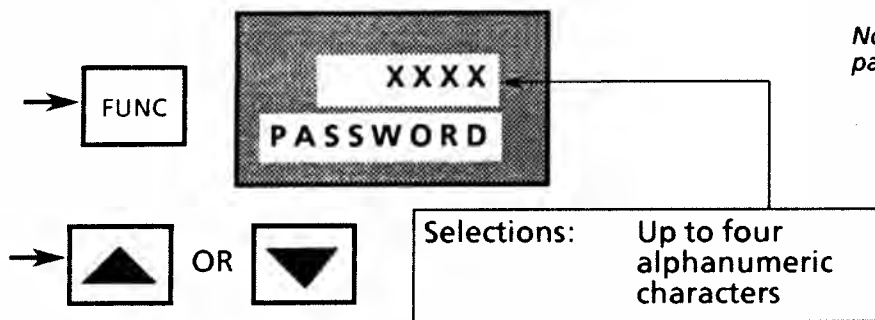

REMARKS
 Note that XXXX is factory default password.

3. Use [RAISE] or [LOWER] key to enter password to gain access to LOCKOUT prompt.

4 Configuring Your Recorder -- Continued

L. LOCKOUT Configuration -- Continued

4. If correct password was entered, press [FUNC] key to call up LOCKOUT prompt.

REMARKS
Do not configure this selection for lockout until all configuration is complete.

Selections: NONE	(No lockout)
CALIB	(Calibration is locked out)
+ CONF	(Tuning, Set point ramp and program available for Read/Write; Configuration groups Read-Only, Calibration is not available)
+ VIEW	(Same as for + CONF selection)
MAX	(Calibration groups are not available. All other groups are Read-Only)

5. Use [RAISE] or [LOWER] key to select desired lockout action, or go to Step 6.

NOTE: To recall original value or selection, press [RUN/HOLD] key before pressing [FUNC] key again.

6. Press [FUNC] key to call up next parameter and enter present selection.

IMPORTANT:

REMARKS
Be sure to record new password in safe location. If you forget your password, you will have to call our technical assistance center (1-800-423-9883) to find out how to enter a new one.

Selections:	0 to 9 A to Z
-------------	------------------

7. Use [RAISE] or [LOWER] key to change default password to one of your own, or go to Step 8.

8. Press [SET UP] key to call up next group prompt and go to appropriate procedure in this section. Or, press [LOWR DISP] key to exit Configuration Mode.

NOTE: Following the CONFIGURATION prompts described above, a STATUS prompt is displayed; this allows the user to review (Read Only) the status of the recorder's self diagnostic tests (see Service section).

Configuration Worksheet

DR 4500 Truline Recorder

With or Without Control

Group Prompt	Function Prompt	Value or Selection
TUNING 1	PB or GAIN	
	RATE MIN	
	RSET MIN or RPM	
	MAN RSET	
	CYC SEC	
	PB 2 or GAIN 2	
	RATE2MIN	
	RSET2 MIN or RPM	
	CYC2SEC	
	TUNING 2	PB or GAIN
RATE MIN		
RSET MIN or RPM		
MAN RSET		
CYC SEC		
PB 2 or GAIN 2		
RATE2MIN		
RSET2 MIN or RPM		
CYC2SEC		
SP RAMP 1	SP RAMP	
	TIME MIN	
	FINAL SP	
	SP PROG	See Program Record Sheet in Appendix C
SP RAMP 2	SP RAMP	
	TIME MIN	
	FINAL SP	
	SP PROG	See Program Record Sheet in Appendix C

Group Prompt	Function Prompt	Value or Selection
CHART	CHRT SPD	
	HOUR/REV	
	TIME DIV	
	CONTINUE	
	CHRT NAM	
	HEADER	
	REM SW	
	WAKE MIN	
	WAKE HR	
TIME	MINUTES	
	HOURS	
	DAY	
	MONTH	
	YEAR	
	DAY	

Configuration Worksheet

DR 4500 Truline Recorder

With or Without Control

Group Prompt	Function Prompt	Value or Selection
PEN 1 (SET UP)	PEN 1 IN	
	CHART1HI	
	CHART1LO	
	PEN1 ON	
	PEN1 OFF	
	MAJORDIV	
	MINORDIV	
	RNG1TAG	
PEN 2 (SET UP)	PEN 2 IN	
	CHART2HI	
	CHART2LO	
	PEN2 ON	
	PEN2 OFF	
	MAJORDIV	
	MINORDIV	
	RNG2TAG	
PEN 3 (SET UP)	PEN3IN	
	CHART3HI	
	CHART3LO	
	PEN3 ON	
	PEN3 OFF	
	MAJORDIV	
	MINORDIV	
	RNG3TAG	
PEN 4 (SET UP)	PEN 4 IN	
	CHART4HI	
	CHART4LO	
	PEN4 ON	
	PEN4 OFF	
	MAJORDIV	
	MINORDIV	
	RNG4TAG	

Group Prompt	Function Prompt	Value or Selection
INPUT 1	ENABLE	
	DECIMAL	
	UNITS	
	ENG UNIT	
	IN1 TYPE	
	XMITTER	
	IN1 HI	
	IN1 LO	
	INPTCOMP	
	FILTER 1	
INPUT 2	ENABLE	
	DECIMAL	
	UNITS	
	ENG UNIT	
	IN2 TYPE	
	XMITTER	
	IN2 HI	
	IN2 LO	
	INPTCOMP	
	FILTER 2	
BURNOUT		

Configuration Worksheet

DR 4500 Truline Recorder

With or Without Control

Group Prompt	Function Prompt	Value or Selection
INPUT 3	ENABLE	
	DECIMAL	
	UNITS	
	ENG UNIT	
	IN3 TYPE	
	XMITTER	
	IN3 HI	
	IN3 LO	
	INPTCOMP	
	FILTER 3	
BURNOUT		
INPUT 4	ENABLE	
	DECIMAL	
	UNITS	
	ENG UNIT	
	IN4 TYPE	
	XMITTER	
	IN4 HI	
	IN4 LO	
	INPTCOMP	
	FILTER 4	
BURNOUT		
TOTAL 1	TOTAL EU	
	RATE	
	SCALER	
	RSETABLE	

Group Prompt	Function Prompt	Value or Selection
TOTAL 2	TOTAL EU	
	RATE	
	SCALER	
	RSETABLE	
CONTROL 1	PID SETS	
	SW VALUE	
	SP SOURCE	
	RATIO	
	BIAS	
	SP TRACK	
	POWER UP	
	SP HILIM	
	SP LOLIM	
	OUT/ACTION	
	OUT HILIM	
	OUT LOLIM	
	DROPOFF	
	DEADBAND	
	OUT HYST	
	FAILSAFE	
	REM SW	
	MAN KEY	
	PB or GAIN	
	MIN or RPM	
CONT1ALG		
OUT1 ALG		
4-20mA RNG		
SHEDMODE		
SHED SP		

Configuration Worksheet

DR 4500 Truline Recorder

With or Without Control

Group Prompt	Function Prompt	Value or Selection
CONTROL 2	PID SETS	
	SW VALUE	
	SP SOURCE	
	RATIO	
	BIAS	
	SP TRACK	
	POWER UP	
	SP HILIM	
	SP LOLIM	
	OUT/ACTION	
	OUT HILIM	
	OUT LOLIM	
	DROPOFF	
	DEADBAND	
	OUT HYST	
	FAILSAFE	
	REM SW	
	MAN KEY	
	PB or GAIN	
	MIN or RPM	
	CONT2 ALG	
	OUT2 ALG	
4-20mA RNG		
SHEDMODE		
SHED SP		

Group Prompt	Function Prompt	Value or Selection	
OPTIONS	INPUT 1		
	INPUT 2		
	INPUT 3		
	INPUT 4		
	CONTROL 1		
	CONTROL 2		
	REJ FREQ		
	RELHUMID		
	ATMPRES		
	DEVIATION		
	DEVSETPT		
	ComSTATE		
	ComADDR		
	SHEDTIME		
	UNITS		
	ALARMS	A1S1 VAL	
		A1S2 VAL	
A1S1 TYPE			
A1S2 TYPE			
A1S1 HL			
A1S1 EV			
A1S2 HL			
A1S2 EV			
A2S1 VAL			
A2S2 VAL			
A2S1 TYPE			
A2S2 TYPE			
A2S1 HL			
A2S1 EV			
A2S2 HL			
A2S2 EV			
AL HYST			
LOCKOUT	LOCKOUT		
	CHANGE		

Operation and Maintenance

Section 5

Introduction

This section provides procedures and reference data for operating the recorder and for performing routine maintenance tasks. In this section, it is assumed that the recorder has been properly installed and configured, and that inputs are properly calibrated. (See Sections 2, 3, 4, and 6.)

Some of the procedures in this section are required only initially, and some are required only randomly, as conditions dictate. Once the recorder is up and running, required operation actions are infrequent and straightforward.

In general, this section is divided into two main parts:

- Operating the recorder, after it has been installed and configured, and
- Performing routine maintenance such as installing new charts.

Operating the Recorder

Operating the recorder includes these activities:

- Preparation and Start-up,
- Monitoring Operation, and
- Actions an Operator Can Take

Preparation and Start Up

Perform these remaining preparation tasks before start-up:

- Install or replace the circular chart as described under "Routine Maintenance."
- Be sure that configured settings for the current time and wake time (time at which recording begins) are correct. Note that the recorder is "awake" during start-up to verify interaction with the process.

If you are not already familiar with the indicators, displays, and keys that make up the recorder's operator interface, you may want to review the descriptions given in Display and Keypad Descriptions in the Configuration section before proceeding.

During start-up, you verify the interaction between your process and the DR 4500 recorder so be sure that your process can tolerate some upsets during this procedure.

Procedure (All Models)

1. Open recorder door. Apply power and wait for recorder to run its power-up tests.

NOTE: • If failsafe starts blinking in the lower display, see the Service section for troubleshooting data.

- For recorders with two controllers (both enabled), be sure the CHN '1' indicator is lit for steps 2-7. If CHN 1 is not lit, sequentially press the [LOWR DISP] key until "1" is lit when "OUT" is displayed.

2. For recorder only model, just check that "pen" is operating and skip to step 8.

3. Check that MAN indicator is on. If it is not on, press [MAN/AUTO] key. With MAN on, controller is in manual mode and output (OUT) in percent is displayed in lower display.

4. Use [↑] and/or [↓] to raise/lower output percentage and check for corresponding CHNge in final control element and PV value in upper display as well as pen trace on chart.

5. If you know from experience that configured PB or GAIN, RATE, RESET, etc. values provide desired controller response to process changes, skip this step. If you are not sure that TUNING values configured are correct, you can manually tune the controller as outlined in Appendix B, Section 10 of this manual.

6. Sequentially press [LOWR DISP] key until SP and local set point value appear in lower display. Use [↑]/[↓] keys to set desired SP value.

NOTE: The local set point cannot be adjusted if the Set Point Ramp function is enabled (H or R in upper display).

7. Press [MAN/AUTO] key to put controller in automatic mode -- A indicator on. Controller will automatically adjust output to maintain PV (upper display) at SP (lower display) as tracked by pen trace, if controller is properly configured and tuned.

8. For recorders with two controllers (both enabled), repeat steps 2-7 for controller #2, but be sure CHN "2" indicator is lit instead of CHN "1." Sequentially press [LOWR DISP] key until "2" is lit when "OUT" is displayed.

9. Close door and monitor operation.

Monitoring Operation

Besides the historical chart record, you can monitor the recorder's indicators and displays to get an instantaneous view of various process conditions and of the control loop status. There are also diagnostic error messages to signal detection of malfunctions in certain internally monitored data.

Meaning of Indicators

During normal operation, the indicators will light for the following reasons.

Indicator	Definition When Lit
ALM 1 2	Alarm condition exists for alarm 1 or 2
CHN 1 2 3 4	PV displayed is for channel 1, 2, 3 or 4
RSP	Remote set point is active or 2nd set point is active.
OUT 1 2	Control relay 1 or 2 is ON.
A or MAN	Indicates the mode of operation: A = Automatic MAN = Manual
F or C or blank	Indicates the temperature units of PV: F = Fahrenheit C = Celsius
R or H or blank (in upper display)	Indicates the state of the set point ramp or program if enabled: R = Run H = Hold blank = Disabled
KEY ERR (in lower display)	Indicates parameter not available, not in set up mode, or key malfunction.



Reading Deviation Bargraph (See Figure 5-1)

In addition to the indicators, a bargraph containing 21 bars displays Process Variable (PV) deviation from set point (SP).

NOTE: When CHN "1" indicator is lit, bargraph display applies for controller #1; and it applies for controller #2, when CHN "2" indicator is lit, if applicable. Sequentially press [LOWR DISP] key to light appropriate CHN indicator (1 or 2) and view corresponding controller displays.

The blue "on-control" bar lights when the PV is within $\pm 1\%$ of SP.

The 10 red bars above the blue one light for each positive deviation up to +10% and the 10 below light for each negative deviation down to -10%. If the process deviation is greater than $\pm 10\%$, the blue bar and the specific red bars light.

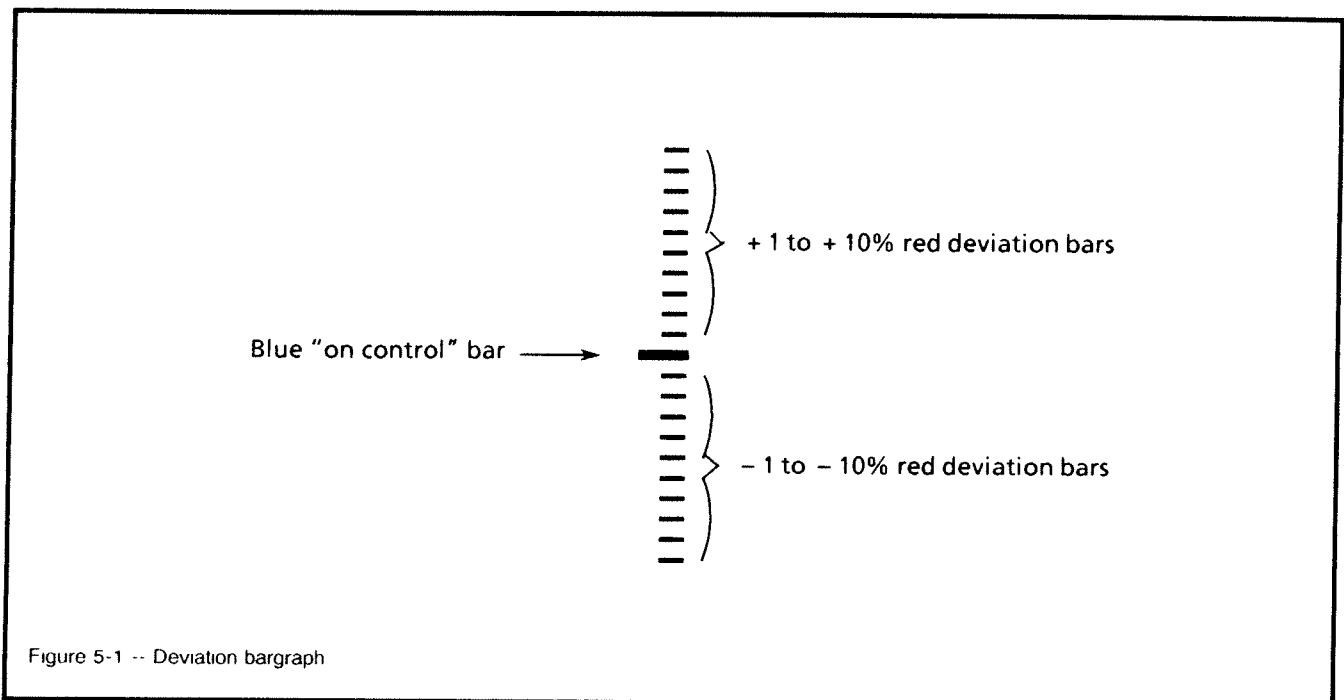

Viewing Displays

The upper display is a 6-character display, four of which show the value of the PV during normal operation.

The lower displays is an 8-character display. During normal operation, you can view various operating parameters by sequentially pressing the [LOWR DISP] key to call up the following prompts and their values.

- NOTE:
- The display will show only those that apply to your specific model and the way it is configured.
 - For recorders with two controllers (both enabled), remember that any controller related values displayed correspond with the lighted CHN indicator -- "1" means that values apply for controller #1 and "2" means that values apply for controller #2.

Prompt	Parameter Definition
OUT	The controller output* in percent (%). Note that output can only be adjusted through raise/lower keys when controller is in MANUAL mode.
SP	Local SP 1,* also current set point of SP Ramp, or set point Ramp/Soak program.
2SP	Local SP 2* (where remote SP does not apply).
RSP	Remote SP (when configured).
2IN	Value of channel 2 input (when available).
3IN	Value of channel 3 input (when available).
4IN	Value of channel 4 input (when available).
DEV	PV deviation from SP (+ 999.9 maximum).
EU	Engineering unit that PV represents (when available).
RH	RH value in percent (%) (when available).
PIDSETX	Tuning parameter set* selected where X = 1 or 2.
RAMP	The time (minutes) remaining in the SP Ramp.
#RA	The time (minutes) remaining in set point ramp.
#SK	The time (minutes) remaining in set point soak.
RECYC	The number of recycles remaining to be run in the SP program.

*Use [↑]/[↓] to change the value of this parameter.



Displaying Totalizer Value Procedure

1. Press [LOWR DISP] until:

Upper Display = T PV VALUE

Lower Display = TOTAL VALUE

NOTE: When two totalizers are configured notice that channels #1 and #2 totalized values are alternately displayed.

2. To display channel #1 totalizer press [↑] or [↓] key until CHN "1" indicator lights.

Upper Display = 1 T PV VALUE

Lower Display = 8 DIGIT MAX TOTALIZATION VALUE

3. To display channel #2 totalizer press [↑] or [↓] key until CHN "2" indicator lights.

Upper Display = 2 T PV VALUE

Lower Display = 8 DIGIT MAX TOTALIZATION VALUE

4. To return to alternating display of channels #1 and #2 totalized values, press [↑] and [↓] keys simultaneously.

Upper Display = SCAN

Lower Display = 8 DIGIT MAX VALUE

After keys are released, upper display alternately shows #1, #2 PV values while lower display shows #1, #2 totalization values.

5. Press [LOWR DISP] key to return to normal PV display.

Monitoring External Event Operation

If a pen input has been configured as DGTL1 or DGTL2, the pen (channel) will operate as an "event pen" and track the remote contact (switch) closure via the digital 1 or digital 2 input wired to the alarm output/digital input PCB. When the switch is open, the trace for the channel tracks at the configured OFF position (0-100%) on the chart; when the switch closes, the trace tracks at the configured ON position (0-100%) on the chart and tracks at this position until the switch is opened. Thus, the "event pen" record makes it easy to monitor the on/off operation of an external event.

Meaning of Diagnostic Error Messages

The DR 4500 runs background tests to verify data and memory integrity. If there is a malfunction, one of the error messages listed below will blink in the lower display. The list gives the condition causing the malfunction, but refer to the Service section for troubleshooting details.

Error Message Prompt	Condition
EE FAIL	Unable to write to non-volatile memory.
FAILSAFE	Failsafe
INP1FAIL	Two consecutive failures of input 1 integration.
INP2FAIL	Two consecutive failures of input 2 integration.
INP3FAIL	Two consecutive failures of input 3 integration.
INP4FAIL	Two consecutive failures of input 4 integration.
INP1RNG	<i>Input 1 out-of-range:</i> Linear: $\pm 10\%$ Characterized: $\pm 1\%$
INP2RNG	<i>Input 2 out-of-range:</i> Linear: $\pm 10\%$ Characterized: $\pm 1\%$
INP3RNG	<i>Input 3 out-of-range:</i> Linear: $\pm 10\%$ Characterized: $\pm 1\%$
INP4RNG	<i>Input 4 out-of-range:</i> Linear: $\pm 10\%$ Characterized: $\pm 1\%$
PVLIMIT	PV $\pm 10\%$ out-of-range.
RVLIMIT	Remote variable out-of-range. NOTE: $RV = (\text{input } 2 \times \text{ratio}) + \text{bias}$



Actions an Operator Can Initiate

An operator can change the control mode, adjust the output manually, change the SP and switch between SPs, run a set point ramp, disable the set point ramp, run a set point program, disable the set point program, switch between two sets of PID values, check alarm set points, reset totalizer, and run a key test. Note that some actions depend upon how the recorder was configured and the features supplied on your particular recorder model.

Changing Control Mode and Adjusting Output Manually

NOTE: For recorders with two controllers (both enabled), remember that any controller related values displayed, including controller mode, correspond with the lighted CHN indicator -- "1" means that values apply for controller #1 and "2" means that values apply for controller #2. Sequentially press [LOWR DISP] key to step through displays and light appropriate CHN indicator for controller related values.

Procedure

1. Alternately press [MAN/AUTO] key to change control mode from automatic to manual:

In Automatic Mode, A indicator is on and:

- Upper Display = PV value,
- Lower Display = SP and SP value.

Controller regulates its output to maintain PV at desired SP.

In Manual Mode, MAN indicator is on and:

- Upper Display = PV value,
- Lower Display = OUT and output value in %.

Go to Step 2 to adjust output manually.

2. Press [↑] or [↓] key to raise or lower output value shown in lower display when controller is in manual mode.

REFER TO THE CONFIGURATION SECTION TO DISPLAY OR CHANGE THESE ASSOCIATED CONTROL PARAMETERS.

Parameter	Group Prompt	Function Prompt
Output Direction	CONTROL 1 or 2	ACTION
Output Limits	CONTROL 1 or 2	OUTLOLIM, OUTHILIM
Controller Dropoff Value	CONTROL 1 or 2	DROPOFF
Failsafe Output Value	CONTROL 1 or 2	FAILSAFE

Changing SP and Switching Between SPs

NOTE: For recorders with two controllers (both enabled), remember that any controller related values displayed correspond with the lighted CHN indicator -- "1" means that values apply for controller #1 and "2" means that values apply for controller #2.

CHNging SP and Switching Between SPs (continued)

Procedure

1. Be sure that controller is in automatic mode, if applicable, and lower display shows SP and SP value.
2. Press [↑] or [↓] key to raise or lower local SP value in lower display as required.
3. If Remote Set Point or 2nd Local Set Point has been configured, press [FUNC] to alternately select Local SP or Remote SP, or switch between two local SPs.

NOTE: You cannot perform this task, if Remote SP or 2nd Local SP is not configured, or if you attempt to change SP while SP ramp is enabled.

4. Refer to following table for summary of indications and actions associated with a given type of SP.

	Using Local Set Point	Using Remote Set Point*	Using 2nd Local Set Point
RSP Indicator	OFF	ON	ON
Upper Display	PV	PV	PV
Lower Display	SP and Local SP value	RSP and Remote SP value	SP2 and 2nd Local SP value
To Change SP Value	Press [↑] or [↓]	Cannot change at keypad	Press [↑] or [↓]

5

*INPUT 3 is RSP for controller #1 and INPUT 4 is RSP for controller #2.

REFER TO THE CONFIGURATION SECTION TO DISPLAY OR CHANGE THESE ASSOCIATED SET POINT PARAMETERS.

Parameter	Group Prompt	Function Prompt
Set Point Source	CONTROL 1 or 2	SP SOURCE
HI and LO Set Point Limit Values	CONTROL 1 or 2 or LIMIT	SP HILIM, SP LOLIM

Running a Set Point Ramp

You can RUN or HOLD a single set point ramp that has been configured to occur between the current local set point and a final local set point over a time interval of from 1 to 255 minutes. See Configuration section for programming details.

NOTE: For recorders with two controllers (both enabled), remember that any controller related values displayed correspond with the lighted CHN indicator -- "1" means that values apply to controller #1 and "2" means that values apply for controller #2.

Running a Set Point Ramp (continued)**Procedure**

1. Be sure that controller is in automatic mode and H (hold) appears with PV value in upper display. If H doesn't appear, go to SP Ramp Configuration procedure and use it to enable instead of disable SP ramp function.
2. Press [RUN/HOLD] key. H CHNges to R in upper display and SP value will start increasing or decreasing toward final set point value. PV value and pen trace will also change.
3. To HOLD ramp at current SP value, press [RUN/HOLD] key. Press key again to continue run.
4. To view remaining time for ramp, press [LOWR DISP] key until:
 - Upper Display = R or H and PV value
 - Lower Display = RAMPXXXM (time remaining)
5. When final set point value is reached, R changes to H in upper display and controller operates at final set point value.

NOTE: Local SP value becomes the same as final ramp SP at the end of SP ramp cycle.

Disabling SP Ramp

Procedure: Refer to SP Ramp Configuration procedure.

Running a Set Point Ramp/Soak Program

You can Run or Hold a multiple segment set point program that has been configured with the required data. See the Configuration section for programming details.

NOTE: For recorders with two controllers (both enabled), remember that any controller related values displayed correspond with the lighted CHN indicator -- "1" means that values apply for controller #1 and "2" means that values apply for controller #2.

Procedure

1. Be sure that recorder is in automatic mode and H (hold) appears with PV value in upper display. If H doesn't appear, go to SP Program Configuration procedure and use it to enable program instead of disabling SP program.
2. Press [RUN/HOLD] key. H changes to R in upper display to indicate that program is running. PV value and pen trace will track ramp/soak profile.
3. To HOLD set point program, press [RUN/HOLD] key. Press key again to continue run.
4. (a) To view present ramp or soak number and time, press [LOWR DISP] key until:
 - Upper Display = "R" and the PV value
 - Lower Display = #RA and the time for the ramp, or #SK and the time for the soak
 (b) To view number of cycles left in program, press [LOWR DISP] key until:
 - Upper Display = "R" and the PV value
 - Lower Display = RECYC and the number of cycles remaining to be run in program
5. When final segment is completed, the "R" in upper display changes to "H" and recorder operates at last set point in program. If you want to disable or abort program, refer to SP Program Configuration procedure.

Running a Set Point Ramp/ Soak Program using a Remote Contact

NOTE: Procedure assumes that SP program has been enabled and ramp/soak segments have been configured.

Procedure

1. Be sure that controller is in automatic mode and H (hold) appears with PV value in upper display.
2. Momentarily close contacts for digital input #1, H starts to blink.
3. Open digital input #1, R is displayed and program runs.
4. Repeat Steps 2 and 3 to change state of SP program from Hold to Run or Run to Hold, as required.

Switching Between Two Sets of PID Values

If the PIDSETS function has been configured as 2KEYBD, you can use the following procedure to switch between the two sets of PID values. See Configuration section for details.

NOTE: For recorders with two controllers (both enabled), remember that any controller related values displayed correspond with the lighted CHN indicator -- "1" means that values apply for controller #1 and "2" means that values apply for controller #2.

Procedure

1. Press [LOWR DISP] until:
Upper Display = PV value
Lower Display = PIDSET1 or PIDSET2
2. Press [↑] or [↓] to change PIDSET1 or PIDSET2 or vice versa.

Checking Alarm Set Points

The recorder has two alarms with two configurable set points per alarm. You can check/change the values that have been configured for the set points as follows.

Procedure

1. Press [SET UP] key until:
Upper Display = SET UP
Lower Display = ALARMS
2. Press [FUNC] key:
Upper Display = Alarm SP Value
Lower Display = A1S1 VAL (Alarm 1 Set Point 1)
3. To change SP value, press [↑] or [↓] key to raise or lower value as required.
4. Repeat steps 2 and 3 as required to check/change remaining set point values -- A1S2 VAL, A2S1 VAL, and A2S2 VAL.



Checking Alarm Set Points (continued)

REFER TO THE CONFIGURATION SECTION TO DISPLAY OR CHANGE THESE ASSOCIATED ALARM PARAMETERS.

Parameter	Group Prompt	Function Prompt
Alarm Types	ALARMS	A1S1TYPE, A1S2TYPE, A2S1TYPE, A2S2TYPE
Alarm State	ALARMS	A1S1 H L, A1S2 H L, A2S1 H L, A2S2 H L
Alarm Hysteresis	ALARMS	AL1 HYST, AL2 HYST

Resetting Totalizer

If the totalizer is enabled and has been configured as resettable, you can reset the current totalized value as follows. See Configuration section for details.

Procedure

1. Press [SET UP] until:
Upper Display = SET UP
Lower Display = TOTAL 1 or TOTAL 2
2. Press [FUNC] key once:
Upper Display = Ex XXX
Lower Display = (some value)
3. Press [FUNC] key once:
Upper Display = NO
Lower Display = RSET TOT
4. Press [↑] or [↓] key to CHNge NO to YES in upper display.
5. Press [LOWR DISP] key to return to normal operation.

Closing Remote Contact (Switch)

The Digital Input Option detects the state of external contacts wired to it (see Installation section). On contact closure, the recorder responds according to how you configured the REM SW function prompt under the Options group. The following table summarizes the “Action on Contact Closure” and the “Display Indication” for a given REM SW prompt selection.

REM SW Prompt Selection	Action on Contact Closure	Display Indication
TO MAN	Puts controller in Manual mode (transfer if in automatic)	Blinking MAN indicator
TO LSP	Switches out Remote Set Point and selects Local Set Point (transfer if in remote set point)	Blinking RSP indicator
TO 2SP	Switches out first Local Set Point and selects second Local Set Point (transfer if in set point 1)	Blinking RSP indicator
TO DIR	Puts controller in Direct control action (transfer if in reverse)	None
RN/HLD	Puts controller in HOLD state. Puts SP Ramp / SP Program in HOLD state. NOTES: - Keyboard takes priority over external switch for RUN/HOLD function. - On 'contact open', puts SP Ramp / SP Program in RUN state. - If initially in HOLD state, close then open contact to remotely start SP Ramp / SP Program.	Blinking H in upper display



Running Key Test

You can run this key test to verify operation of keys:

Procedure

1. Open recorder door and press [SET UP] and [FUNC] keys together. Release keys and observe these indications:
 - (a) All indicators and display segments light.
 - (b) Upper Display = KEYS
Lower Display = TRY ALL
2. Press each key in turn and look for the corresponding key name to appear in the lower display. Note that, if no key is pressed within 25 seconds, the recorder automatically exits the key test.

Press	Lower Display	Upper Display
[SET UP] [↑] [↓] [RUN/HOLD] [CHART] [MAN/AUTO] or [RESET] [LOWR DISP] [FUNC]	SET UP INCREMENT DECREMENT RUN-HOLD CHART AUTO-MAN or RESET LWR DISP FUNCTION	KEYS  KEYS

Steps for Maximizing Pen Life

1. Store chart paper in a cool, clean dry place where temperature does not exceed 40°C (104°F) and humidity is below 65% RH.
2. Do not expose pen tip and chart paper to abrasive chemicals or dust that cause excessive pen wear.
3. If recorder is used in a dusty atmosphere, provide a positive clean air purge to minimize dust particle accumulation on chart paper.
4. Periodically clean pen arm using cotton swab dipped in alcohol. This is more important when recorder is located in a dusty environment and no clean air purge is used.
5. Never let pen tip ride on chart plate when paper is not present. Use pen lifter to raise arm when changing paper.
6. Keep door closed while recording.
7. Always insert pen arm tip in shipping sponge when storing or shipping recorder.
8. Be sure chart paper lays flat against chart plate. Any ripple in paper will cause light pen printing.
9. Be sure chart hub assembly is pushed onto motor shaft so it is flush with chart plate.

Routine Maintenance

The DR 4500 recorder does not require any periodic maintenance as such. But, you will have to clean the pen tip, and replace the chart and optional chart lamp as required.

Cleaning Pen Tip

NOTE: Cleaning frequency will vary with recording application environment.

1. Open recorder door.
2. Pull the pen lifter up to raise the pen from the chart.
3. Carefully clean pen tip with cotton swab dipped in alcohol.
4. Push pen lifter down to lower pen.
5. Close door and resume normal operation.

Installing/Replacing a Chart

CAUTION: Store replacement charts in a dust-resistant location. Otherwise, accumulated dust on the chart may cause excessive pen tip abrasion which can shorten expected pen life. In addition, you may want to air purge the case, if the recorder is mounted in an extremely dusty environment.

1. Open recorder door.
2. Press the [CHART] key. The pen will move to and stop at the outer limit of pen travel near the edge of the chart. Also, chart rotation will stop and the prompt CHT HOLD (chart hold) will appear in the lower display.
3. Pull the pen lifter up to raise the pen from the chart.
4. Carefully remove the used chart from the hub and retaining clips. (Do not remove hub adapter.)
5. Install the new chart so that its edges are under the four retaining clips and its small alignment hole is over the alignment pin on the hub. (Press chart down completely around hub adapter.)
6. Push the pen lifter down to lower the pen.
7. Press the [CHART] key. The prompt CHT HOLD in the lower display will be replaced by the parameter prompt/value that was last selected using the [LOWR DISP] key. If, in the CHART group, the recorder is configured for HEADER (YES), a new header will be printed, then pen recording of input values will resume. If HEADER (NO) is configured, recording will resume immediately.
8. Be sure to keep door closed during operation to minimize dust collection on the chart.

Replacing Burned-Out Chart Lamp (Optional)

1. Open the recorder door and remove power.
2. Unscrew and remove the hood from the lamp assembly.
3. Push the (bayonet-type) lamp in and turn it counterclockwise to remove it from the socket.
4. Reverse Step 3 to install the replacement lamp (General Instrument type 1828 or equivalent) in the socket.
5. Replace the hood on the lamp assembly.
6. Close the door and apply power.

Calibration

Section 6

Summary

This section describes the field calibration procedures for inputs 1, 2, 3, and 4; and controller outputs 1 and 2. All DR 4500 recorders are factory calibrated prior to shipment. It should not, therefore, be necessary to recalibrate the recorder upon its initial installation. However, you must recalibrate the input if any one of the conditions summarized below applies.

- The thermocouple or RTD input must meet published* accuracy rates. Note that factory calibration at reference is $\pm 1.2^\circ\text{F}$ plus ± 10 microvolts for thermocouples or ± 0.3 ohms for RTDs.
- You are using a 0-10 Vdc input. Recalibration is necessary because the resistor network used for this input has a tolerance of $\pm 1.0\%$.
- You have cause to believe that the recorder is out of calibration.
- You must perform regularly-scheduled or periodic recalibration based on your own needs.
- You have performed specific servicing activities such as the replacement of an input PCB.

NOTE: Replacing a main PCB does not normally require recalibration, since a new main PCB is already factory calibrated, whereas an input PCB is not.

- You have changed the input type through configuration which results in the loss of the previous field calibration, but restores factory calibration. See the Restoring Factory Calibration paragraph that follows.



Restoring Factory Calibration

- The factory calibration constants for all the input actuation types that can be used with the DR 4500 recorder are stored in its non-volatile memory. Thus, you can quickly restore the “factory calibration” for a given input actuation type by simply configuring the actuation type through the IN1 TYPE (or IN2 TYPE, IN3 TYPE, IN4 TYPE) prompt to another type and then changing it back to the original type.

For example, assume that your recorder is configured for a type J thermocouple for input 1. To restore the factory calibration for a type J input, call up the IN1 TYPE function prompt and change the actuation type to type K; then, change the actuation type back to type J.

CAUTION: A restored factory calibration overwrites any previous field calibration done for the input. Be sure to protect any field calibration from accidental “overwrites” by configuring the appropriate LOCKOUT selection after calibration.

*Specifications 44-45-03-08

Equipment Needed

Common Equipment

- Bladed screwdriver, medium size (for general use).
- Bladed screwdriver, small size (for use with screws on connector plugs).

Equipment for Thermocouple Inputs (for Ice Bath Method)

- A calibration device with $\pm 0.02\%$ accuracy for use as a signal source.
- Thermocouple extension wires of the same type as the thermocouple being used as an input to the recorder.
- Two insulated copper leads for connecting the calibrator to the thermocouple extension wires at the ice bath.
- Two containers of crushed ice.

Equipment for Thermocouple Inputs (for Precision Resistor Method)

- A calibration device with $\pm 0.02\%$ accuracy for use as a signal source.
- Two insulated copper leads for connecting the calibrator to the recorder.
- A 2000-ohm precision resistor ($\pm 0.02\%$) for use in the input circuit of the recorder.

Equipment for RTD Inputs

- A resistance decade box with $\pm 0.02\%$ accuracy, capable of providing stepped resistance values over a minimum range of 0 to 1400 ohms, and with a resolution of 0.01 ohm.
- Three insulated copper leads for connecting the decade box to the recorder.

Equipment for Milliampere, Millivolt, and Volt Inputs

- A calibration device with $\pm 0.02\%$ accuracy for use as a signal source.
- Two insulated copper leads for connecting the calibrator to the recorder.

Minimum and Maximum Range Values

Calibrate the recorder for the minimum (0%) and maximum (100%) range values for your particular sensor. If your recorder has two or more inputs, calibrate each input separately.

Select the voltage or resistance equivalents for the 0% and 100% range values from Table 6-1. Use these values when calibrating the recorder.

TABLE 6-1 -- Voltage and Resistance Equivalents for 0% and 100% Range Values

Sensor Type	PV Input Range		Range Value*		
	°F	°C	0%	68°F/20°C*	100%
Thermocouples					
B	105 to 3300	41 to 1816	0 mV	0.003 mV	13.763 mV
E	-454 to 1832	-270 to 1000	-9.835 mV	1.192 mV	76.358 mV
E (low)	-200 to 1100	-129 to 593	-6.471 mV		44.547 mV
J	0 to 1600	-18 to 871	-0.885 mV	1.019 mV	50.059 mV
J (low)	20 to 770	-7 to 410	-0.334 mV		22.397 mV
K	-320 to 2500	-196 to 1371	-5.822 mV	0.798 mV	54.845 mV
K (low)	-20 to 1000	-29 to 538	-1.114 mV		22.251 mV
NiNiMoly	32 to 2500	0 to 1371	-0.001 mV	1.458 mV	71.330 mV
Nicrosil-Nisil	0 to 2372	-17 to 1300	-0.461 mV	0.525 mV	47.502 mV
R	0 to 3100	-18 to 1704	-0.089 mV	0.111 mV	20.275 mV
S	0 to 3100	-18 to 1704	-0.092 mV	0.113 mV	17.993 mV
T	-300 to 700	-184 to 371	-5.341 mV	0.789 mV	19.095 mV
T (low)	-200 to 600	-129 to 316	-4.149 mV		15.769 mV
W5W26	0 to 4200	-18 to 2315	-0.234 mV	0.062 mV	37.066 mV
W5W26 (low)	0 to 2240	-18 to 1227	-0.234 mV		22.277 mV
RTD					
IEC Alpha + 0.00385 100 ohms	-300 to 900	-184 to 484	25.18 ohms		274.96 ohms
100 ohms (RH)	-130 to 392	-90 to 200	64.30 ohms		175.84 ohms
200 ohms	32 to 752	0 to 400	102.64 ohms		354.40 ohms
200 ohms	32 to 392	0 to 200	102.64 ohms		351.14 ohms
500 ohms	-300 to 900	-184 to 482	125.90 ohms		1374.80 ohms
Linear					
Milliamperes (dc)	4 to 20 mA**		4 mA		20 mA
Millivolts (dc)	0 to 10 mV		0 mV		10 mV
	10 to 50 mV		10 mV		50 mV
Volts (dc)	0 to 5V		0V		5V
	0 to 10V***		0V		10V

6

* Range values for thermocouples are based on a cold junction temperature of 32°F (0°C). These values must be adjusted for 68°F (20°C) ambient temperature when using the precision resistor method for calibrating thermocouple inputs.

** Resistor / Transorb assembly 30756461-002 (supplied with recorder) must be installed in input when using this range. See setup diagram (Figure 6-8) for details.

*** Resistor network 30755232-001 must be installed in input #1 and -002 in input #2, #3 and #4 when using this range. See setup diagram (Figure 6-7) for details.

Preliminary Procedures

1. Remove operating power from recorder.
2. Open door on recorder.
3. Loosen slotted cap screw on right side of chart plate, and open chart plate.

Disconnecting Field Wiring

NOTE: For calibration of inputs 1, 2, 3, and 4, wiring is identical except for the particular circuit board involved.

Depending on the input (1, 2, 3 or 4) you are calibrating:

1. Remove wired plug from input connector on applicable circuit board, as specified below. (See Figure 6-1 for location of circuit boards and input connectors.)

<u>Input No.</u>	<u>Circuit Board</u>	<u>Input Connector</u>
1	Main board	J6
2, 3, 4	Input boards (Optional)	J2

2. Tag and disconnect the field wiring installed in applicable input connector plug.

NOTE: When compared to connector J6 for input 1, input signal polarity is reversed in connector J2 for inputs 2, 3, and 4.

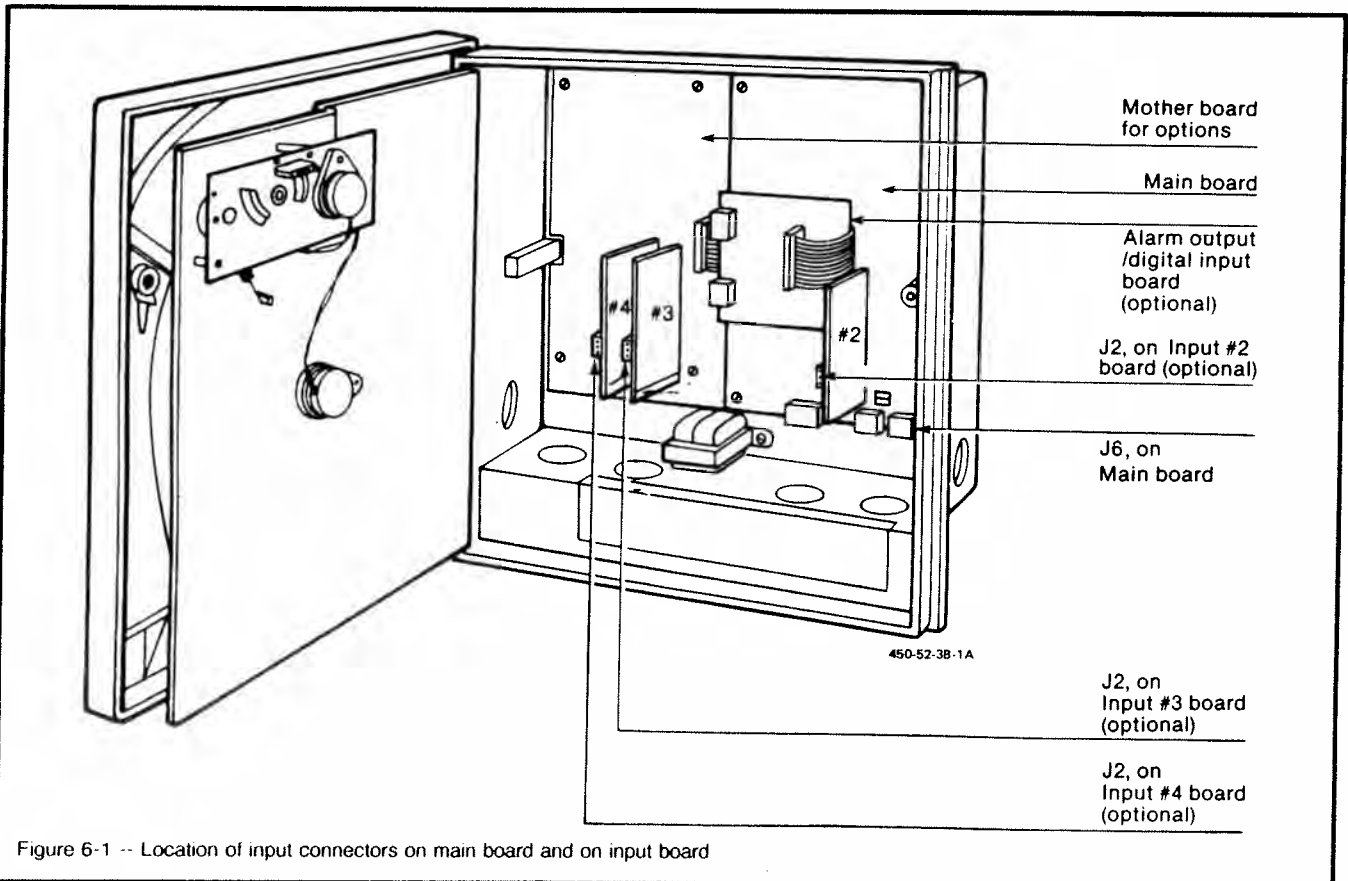

Figure 6-1 -- Location of input connectors on main board and on input board

Calibration Setups for PV Inputs

IMPORTANT:

- Before starting the calibration activity, check that the jumper plug on the applicable circuit board (i.e., main board or input board) is either installed in the proper jumper position (in W1 or in W2, if included on the board) for the particular sensor being used, or has been removed from both of these jumper positions, as applicable. (Refer to the Wiring section of this manual.) See Figure 6-2 for the location of jumper positions W1 and W2 on these circuit boards, and the status of these jumpers for each type of input sensor.
- You can calibrate for a thermocouple input using either of two methods: with the use of an ice bath or with the use of a 2000-ohm precision resistor. (The former method is the more accurate of the two methods.) When using the precision resistor method, you must **remove the jumper plug from jumper position W1** on the applicable circuit board (main board or input board). If the board includes a position W2 for a jumper, install the jumper there; if not, store the jumper where it will not get lost.

NOTE: If you use the precision resistor method, make sure that you restore the jumper plug to position W1 after you have finished calibrating the input.

6

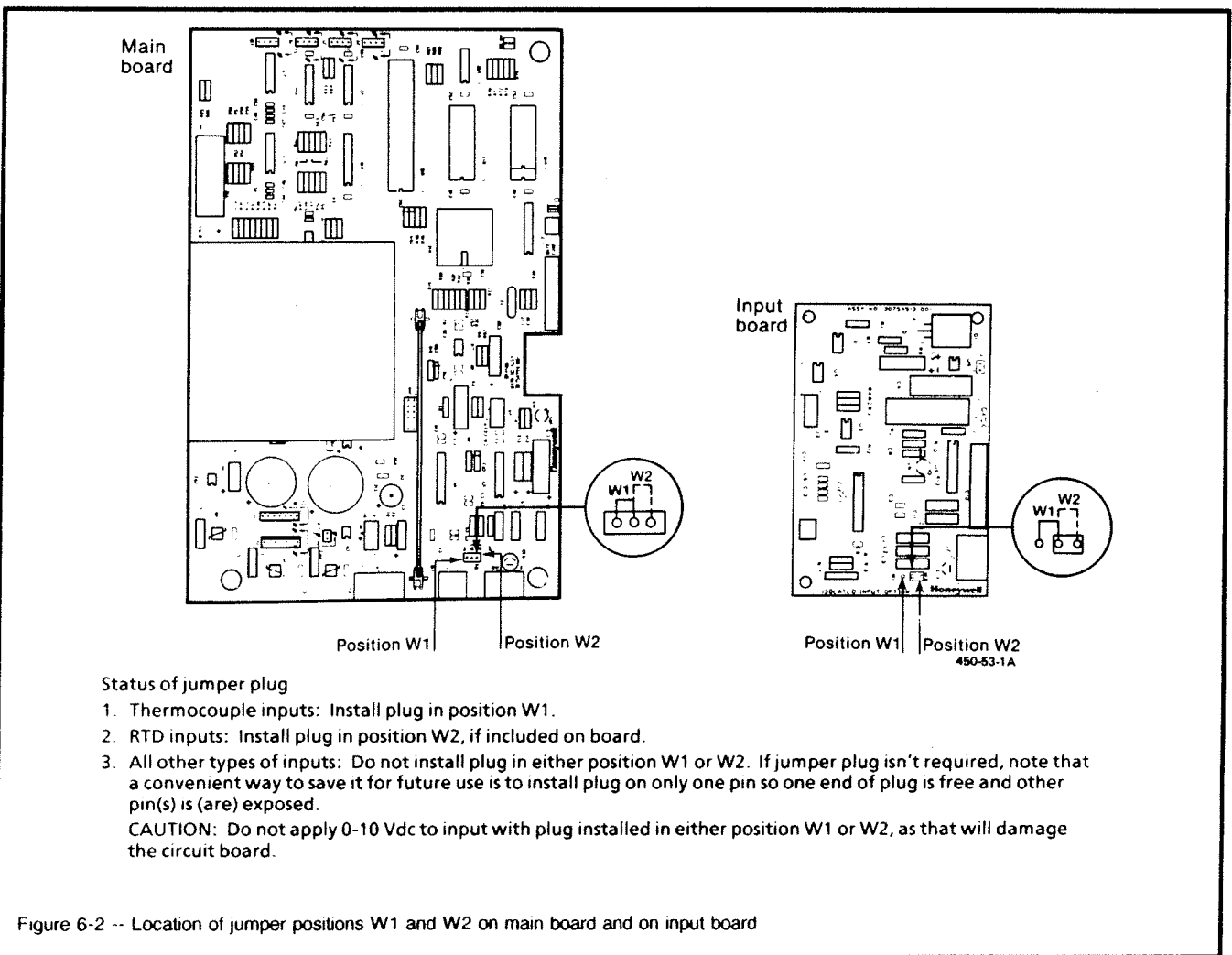

Figure 6-2 -- Location of jumper positions W1 and W2 on main board and on input board

Setup Procedures

General

1. Set up and connect calibrator to input plug for applicable circuit board in your recorder, according to particular input sensor being used, as specified below. (See Figures 6-3 through 6-8 for corresponding setup diagrams.)

NOTE: For best results, route leads (i.e., copper leads or thermocouple extension wires, as applicable) through a conduit hole in the case so that you will be able to close chart plate.

2. Close chart plate after you have completed the applicable calibration setup.

Setup for Thermocouple Inputs (for Ice Bath Method)

NOTE: See Figure 6-3 for setup diagram for following procedure.

1. Connect copper leads to calibration source (Figure 6-3).
2. Connect other end of copper leads to thermocouple extension wires, and insert junction points into containers of crushed ice and water (Figure 6-3).
3. Connect other end of thermocouple extension wires to the clamp type terminals in plug for applicable input connector (i.e., connector J6 or connector J2). (See Figure 6-3.)
4. Reinstall plug in input connector on applicable circuit board as specified below:
 - In connector J6 on main board for input 1.
 - In connector J2 on input board for input 2, input 3, or input 4.

Setup for Thermocouple Inputs (for Precision Resistor Method)

NOTE: See Figure 6-4 for setup diagram for following procedure.

1. Connect calibration source to the clamp-type terminals in plug for applicable input connector (i.e., connector J6 or connector J2), using the copper leads (Figure 6-4).
2. Remove jumper plug from jumper position W1 on applicable circuit board (i.e., main board or input board), and reinstall plug in position W2, if included on the board. (If board does not include position W2, put plug in some convenient location where it won't get lost.)

NOTE: Be sure to restore jumper plug to position W1 when you finish calibrating the input.

3. Install the 2000-ohm precision resistor in the clamp-type terminals in applicable plug (Figure 6-4).
4. Reinstall plug in input connector on applicable circuit board as specified below:
 - In connector J6 on main board for input 1.
 - In connector J2 on input board for input 2, input 3, or input 4.

Setup for Resistance Thermometer Device (RTD) Inputs

NOTE: See Figures 6-5 through Figure 6-8, as applicable, for setup diagrams for following procedure.

1. Connect calibration source to the clamp type terminals in plug for applicable input connector (i.e., connector J6 or connector J2), using the copper leads.
 - For millivolt or volts inputs (except 0 to 10 volts range), see Figure 6-6.
 - For 0 to 10 volts input, see Figure 6-7.
 - For 4 to 20 milliamperes input, see Figure 6-8.
2. Reinstall plug in input connector on applicable circuit board as specified below:
 - In connector J6 on main board for input 1.
 - In connector J2 on input board for input 2, input 3, or input 4.

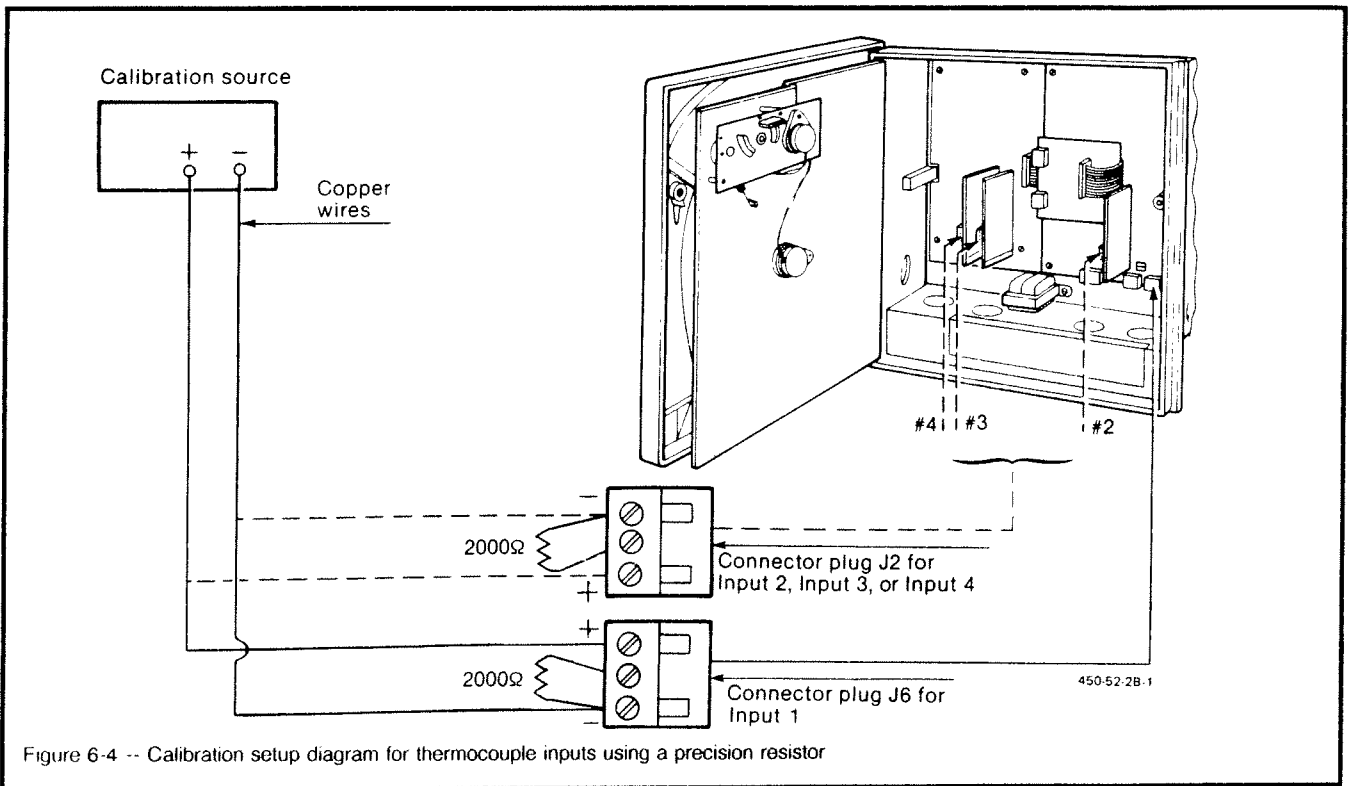
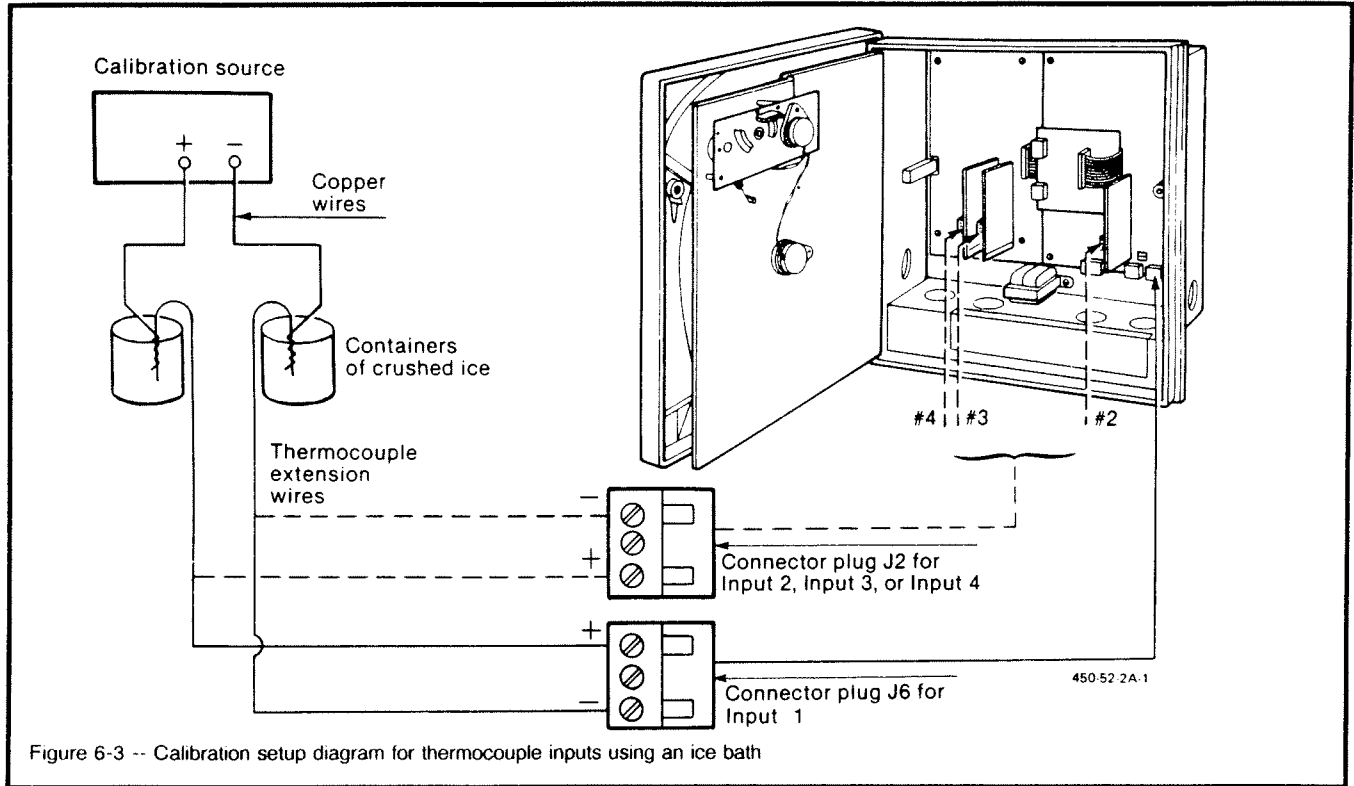

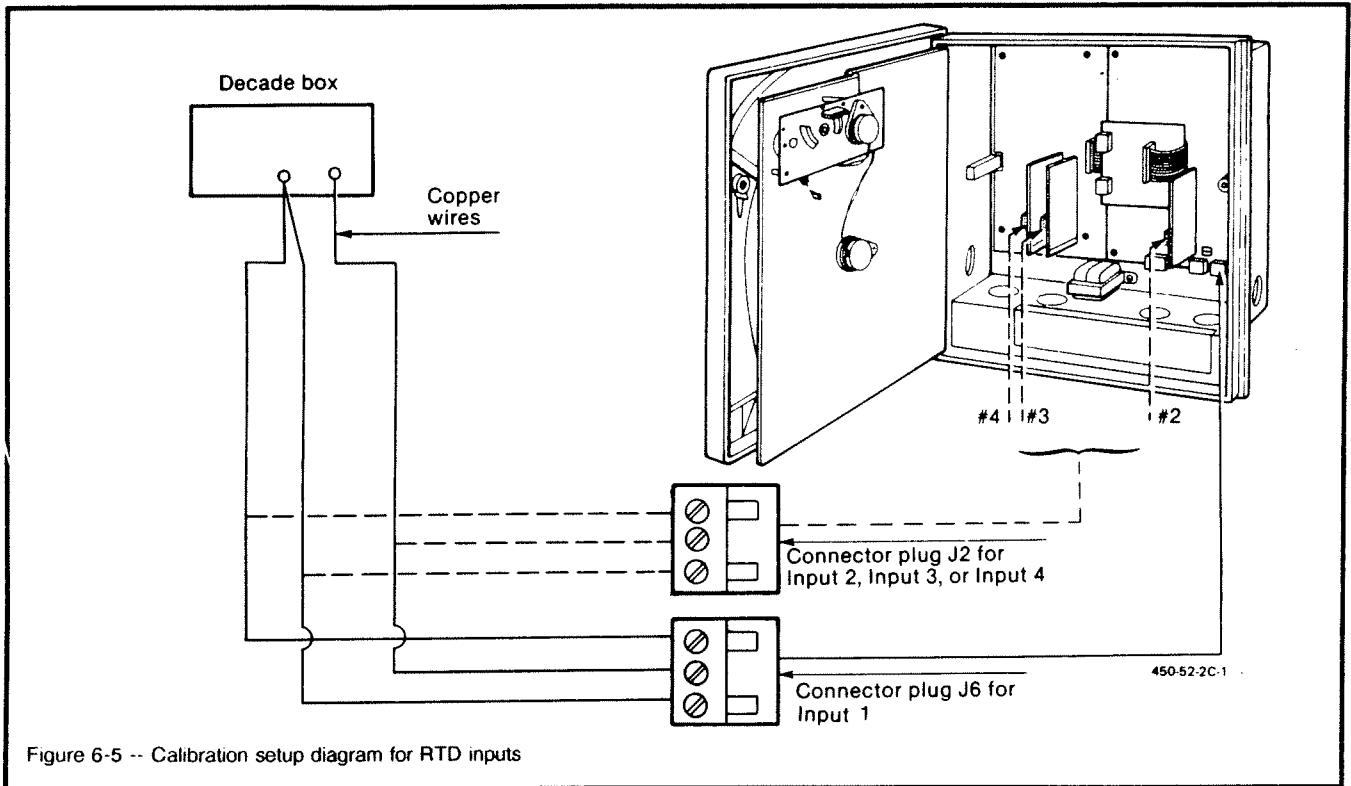

Figure 6-5 -- Calibration setup diagram for RTD inputs

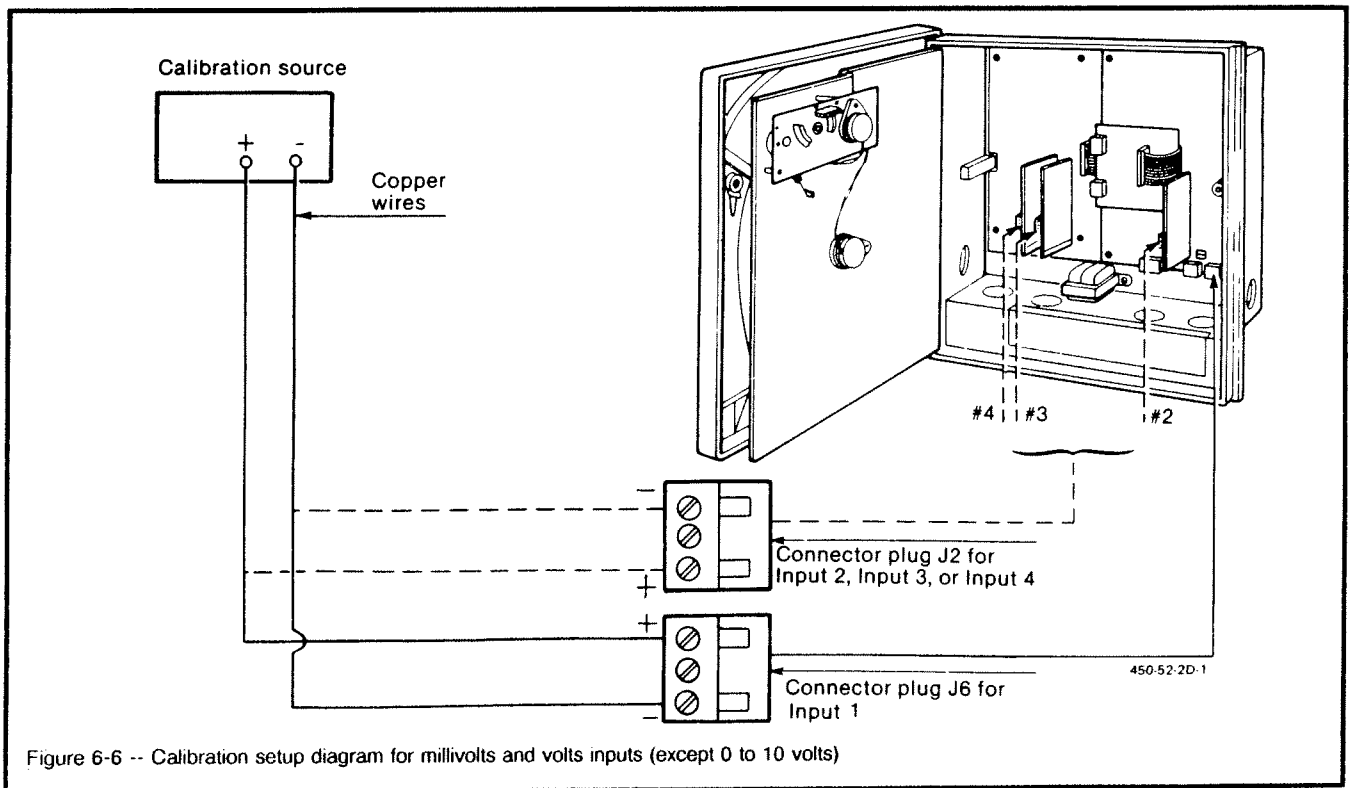
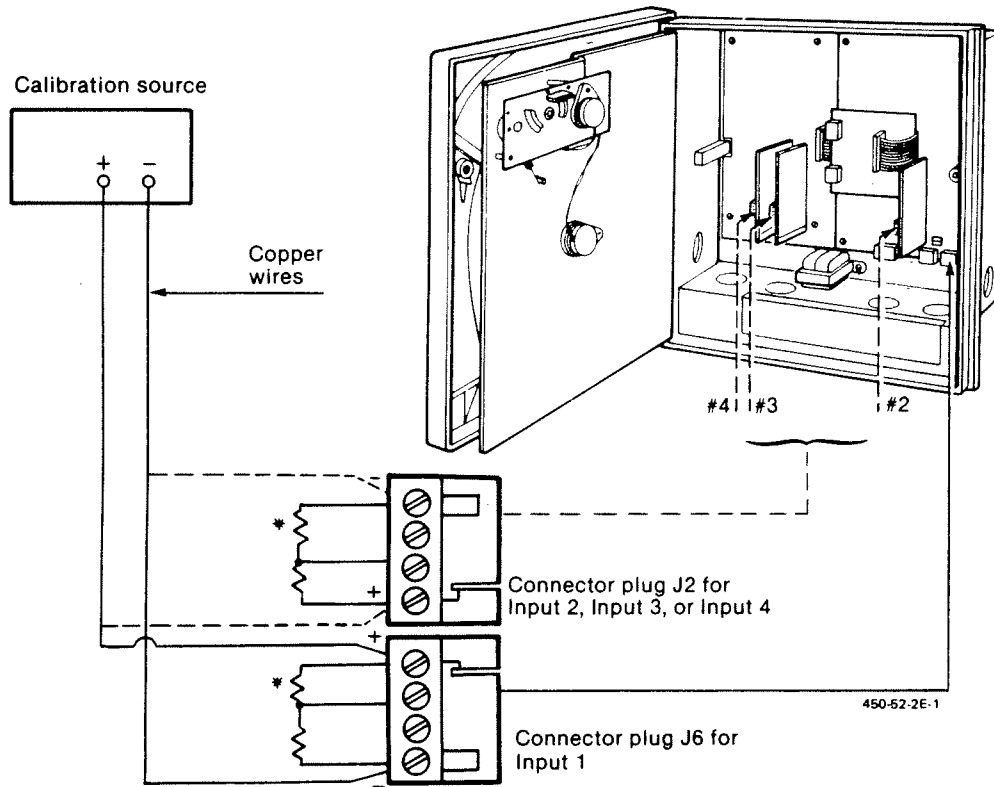

Figure 6-6 -- Calibration setup diagram for millivolts and volts inputs (except 0 to 10 volts)



*Resistor assembly (part no. 30755232-001 for input 1 and 30755232-002 for inputs 2, 3, and 4) is furnished with recorder

6

Figure 6-7 -- Calibration setup diagram for 0 to 10 volts input

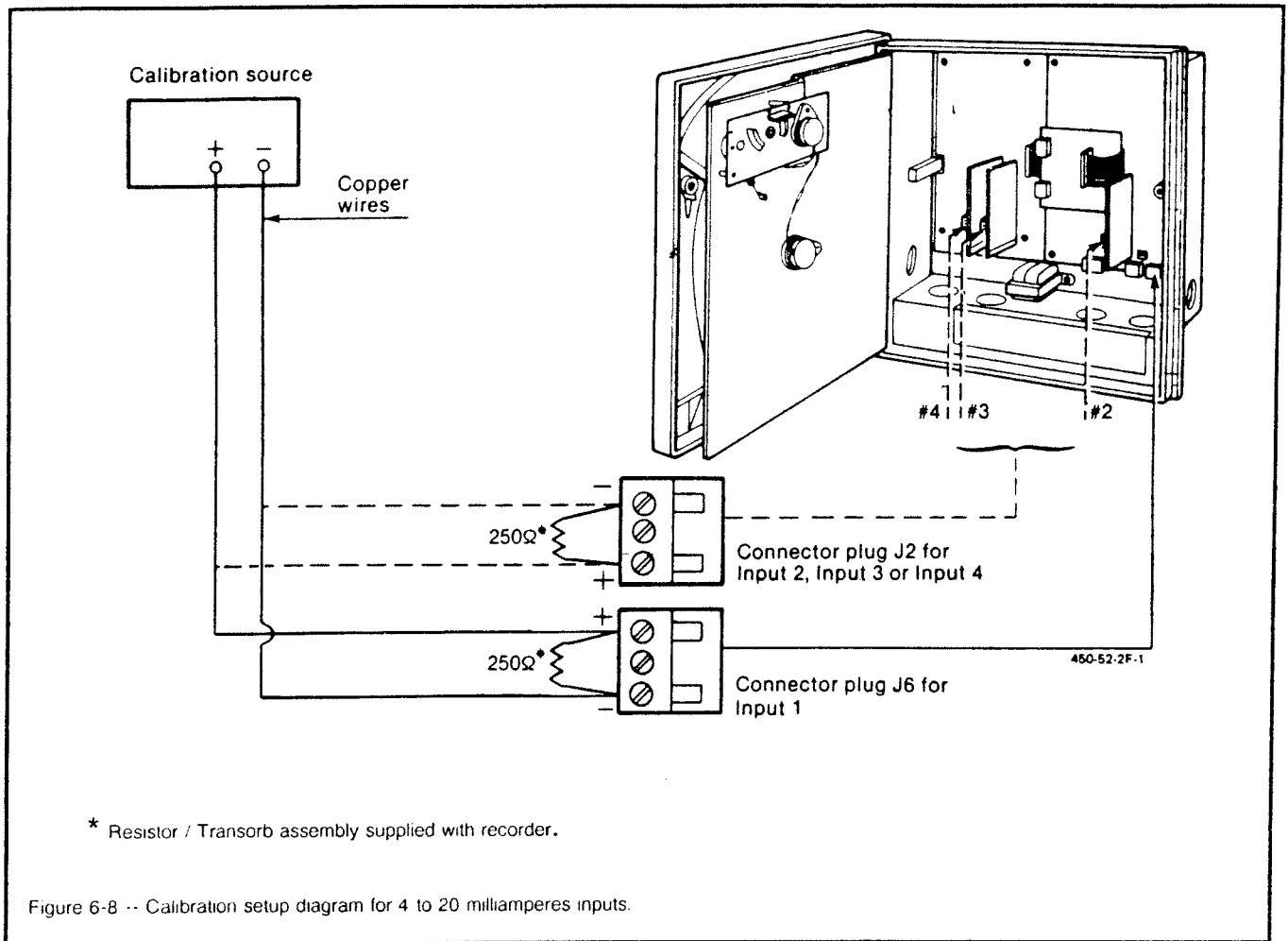

Calibration Sequence

Startup Procedure

1. Apply operating power to calibrator and to recorder.

NOTE: For milliamperes input, be sure the current source is at zero before switching on the calibrator. Do not switch calibrator off/on while it is connected to the recorder's input.

2. Allow recorder to warm up for one hour before starting the calibration.

Enter Calibration Mode

NOTES:

- If the Group prompt LOCKOUT has been configured for CALIB, +VIEW, or MAX selection; you will not be able to call up the CALIB group prompt. See the configuration section of the person who configured the records for details.
- Press [LOWR DISP] or [SET UP] key to exit the Calibration at any time.
- Calibration procedures for inputs 1, 2, 3, and 4 are identical except when input number is shown in lower display. For example:

Lower display shows: **INPUT 1, INPUT 2, INPUT 3, INPUT 4, CAL IN 1, CAL IN 2, CAL IN 3, or CAL IN 4.**

1. Press [SET UP] key until:

Upper display shows: **CALIB**

Lower display shows: **INPUT 1 . . . INPUT 4**, as applicable.

2. Press [FUNC] key until:

Upper display shows: **DISABL**

Lower display shows: **CAL IN 1 . . . CAL IN 4**, as applicable.

3. Press [↑] or [↓] key:

Upper display shows: **BEGIN**

Lower display shows: **CAL IN 1 . . . CAL IN 4**, as applicable.

**Calibrating Input for 0% Range**

1. Press [FUNC] key until:

Upper display shows: **APPLY**

Lower display shows: **IN1 ZERO . . . IN4 ZERO**, as applicable.

2. Adjust calibrator to provide an output signal equal to the 0% range value for your particular input sensor. (See Table 6-1 for appropriate voltage or resistance equivalent.)

NOTE: If you are using the precision resistor method to calibrate a thermocouple input, be sure to subtract the millivolt value for 68°F (20°C) for your particular thermocouple from the 0% value.

For example, for a Type J Thermocouple,

from	-0.885 mV	(Type J @ 0°F)
subtract	<u>+1.019 mV</u>	(Type J @ 68°F)
to yield	-1.904 mV	(calibrator output for IN _n ZERO)

3. Wait 30 seconds, then calibrate input for 100% range as described below.

Calibrating Input for 100% Range

1. Press [FUNC] key:

Upper display shows: **APPLY**

Lower display shows: **IN1 SPAN . . . IN4 SPAN**, as applicable.

2. Adjust calibration source to provide an output signal equal to the 100% range value for your particular input sensor. (See Table 6-1 for appropriate voltage or resistance equivalent.)

NOTES:

- If you are using the precision resistor method to calibrate a thermocouple input, be sure to subtract the millivolt value for 68°F (20°C) for your particular thermocouple from the 100% value.

For example, for a Type J Thermocouple,

from	50.059 mV	(Type J @ 1600°F)
subtract	<u>1.019 mV</u>	(Type J @ 68°F)
to yield	49.040 mV	(calibrator output for IN _n SPAN)

- For linear inputs, avoid step changes in input signal. Vary calibration source signal smoothly from initial value to final 100% value.

3. If you are calibrating an input from a thermocouple, wait 30 seconds, then check the cold junction temperature of the input. (See paragraph below.)

If you are calibrating an input from a sensor other than a thermocouple, wait 30 seconds, then press [FUNC] key.

The working calibration constants for the particular input are now stored.

Checking Cold Junction Temperature of Thermocouple Inputs

NOTES:

- The cold junction temperature appears in the displays only when an input is configured for a thermocouple.
- Check cold junction temperature and change it, if required, after you have calibrated the 100% range of the input.

1. Press [FUNC] key; upper and lower displays show:

Upper display shows: **XXXXXX** (Value shown)*

Lower display shows: **C-J TEMP**

*The value shown in the upper display is in tenths of a degree. It is the current reading of the temperature at the thermocouple terminals (that is, at J2 or J6) as recognized by the recorder. When using the ice bath calibration method, this value should be the terminal ambient temperature; and when using the precision resistor calibration method, this value should be 68°F (20°C).

2. If the cold junction temperature value in the upper display is in error, you can change it by using the [↑] or [↓] key, as applicable.

3. Press [FUNC] key.

The working calibration constants for the particular input are now stored.

Calibrating Input 2, Input 3, and Input 4

Repeat the entire calibration procedure for input 2, input 3, and input 4 as applicable.

Exit Calibration Mode

1. Press [LOWR DISP] or [SET UP] key to exit calibration mode.
2. Open chart plate.
3. Disconnect calibration setup from recorder.
4. Reconnect field input wiring to connector plug, and reinstall plug in connector on circuit board in recorder, as applicable.

NOTE: If you used the precision resistor method to calibrate a thermocouple input, make sure that you have restored the jumper plug to position W1 on the applicable circuit board.

5. Close chart plate, and tighten slotted cap screw to secure chart plate.

Output Calibration

NOTE: Calibration for control outputs 1 and 2 is identical except for the particular PCB involved.

Current Proportional Output

Calibrate the controller so that the output provides the proper amount of current over the desired range.

The controller can provide an output current range of 2 to 21 milliamperes and can be calibrated at 4 mA for 0% of output and 20 mA for 100% of output or any other values between 2 and 21 mA.

Equipment Needed

A standard shop type milliammeter with whatever accuracy is required, capable of measuring 0 to 20 milliamperes.

Connect Calibrator

1. With power off, door open, and chart plate swung out; tag and disconnect field wiring from plug in connector J1 on appropriate control output PCB. (See Figure 6-9.)
2. Observing polarity, connect milliammeter leads to plug for connector J1.
3. Close chart plate. Apply power and let recorder warm-up for 15 minutes before you calibrate.



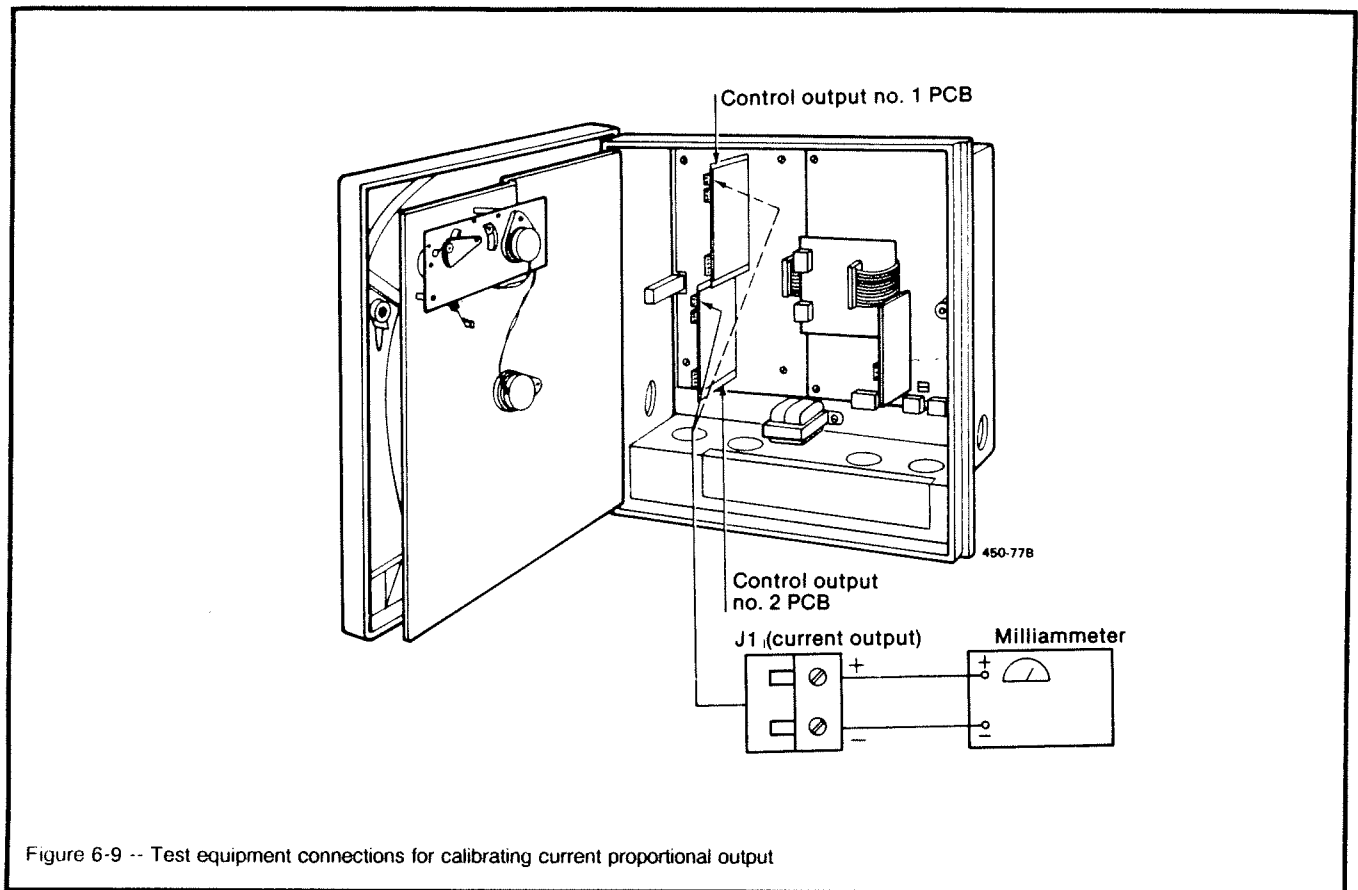

Calibration Procedure

1. Press [SET UP] key until:
 Upper display = **CALIB**
 Lower display = **CURRENT**
2. Press [FUNC] key until:
 Upper display = **(a value)**
 Lower display = **ZERO VAL**
3. Use [↑] or [↓] to raise or lower milliammeter reading to equal desired value for 0% output. (See Table 6-2.)
4. Press [FUNC] key to store 0% value and,
 Upper display = **(a value)**
 Lower display = **SPAN VAL**
5. USE [↑] or [↓] to raise or lower milliammeter reading to equal desired value for 100% output. (See Table 6-2.)
6. Press [FUNC] key to store 100% value. Press [SET UP] or [LOWR DISP] key to exit calibration mode.

Calibration Procedure (continued)**TABLE 6-2**

Reading	4-20 mA Direct	4-20 mA Reverse
0%	4 mA	20 mA
100%	20 mA	4 mA

Position Proportional Output

When the DR 4500 recorder uses the Position Proportional control output, calibrate the controller so that the increase and decrease relays operate properly with respect to the position of the external feedback slidewire.

Connections

Leave all field wiring connected to the plugs in connectors J2 and J5 on the appropriate control output PCB. Apply power and let the recorder warm-up for 15 minutes before you calibrate.

6**Calibration Procedure**

1. Press [SET UP] key until:
Upper display = **CALIB**
Lower display = **POS PROP**
2. Press [FUNC] until:
Upper display = **(a value)**
Lower display = **MTR TIME** (Note that this is the time it takes the motor to travel for 0 to 100%.)
3. Use [↑] or [↓] to adjust motor stroke time to proper value (see motor spec or measure time).
Range of Setting = **5 to 255** seconds
4. Press [FUNC] key until:
Upper display = **DISABL**
Lower display = **POS PROP**

Use [↑] or [↓] key to select automatic or manual calibration:

Upper display = **DO AUTO** or **DO MAN**
Lower display = **POS PROP**

In automatic calibration mode (i.e., DO AUTO), controller relays automatically move motor in proper direction. If desired, however, motor may be manually positioned to 0% and 100% positions but, relay wires must be disconnected. In manual calibration mode (i.e., DO MAN), motor does not move. Instead, existing 0% and 100% values may be manually changed with [↑] or [↓] keys. Use following DO AUTO or DO MAN procedure as applicable.

NOTE: When you exit calibration mode, this selection reverts to DISABL.

DO AUTO

(1) Press [FUNC] key -- turns on decrease relay to drive motor to 0% position:

Upper display = **(0 to 2047)** counts of feedback slidewire
Lower display = **ZERO VAL**

When Upper display stops counting, go to next step.

(2) Press [FUNC] key -- turns on increase relay to drive motor to 100% position:

Upper display = **(0 to 2047)** counts of feedback slidewire
Lower display = **SPAN VAL**

When upper display stops counting, go to Step 5.

DO MAN

(1) Press [FUNC] key:

Upper display = **(existing zero calibration value in counts)**
Lower display = **ZERO VAL**

Use [↑] or [↓] to adjust counts in upper display to desired value.

(2) Press [FUNC] key:

Upper display = **(existing span calibration value in counts)**
Lower display = **SPAN VAL**

Use [↑] or [↓] to adjust counts in upper display to desired value. Go to Step 5.

NOTE: For manual calibration, motor does not move from its position prior to start of Position Proportional calibration.

5. Press [FUNC] key to store value. Press [SET UP] or [LOWR DISP] to exit calibration mode.

Making Adjustments in Printing Characteristics

Normally, there is no need to adjust the printing characteristics as part of an input or output calibration procedure. However if the printed range values appear to be faded, you can use this procedure to make slight adjustments in the print contrast.

NOTE: If the Group prompt LOCKOUT has been configured for CALIB, + VIEW, or MAX selection, you will not be able to access the ADJUST Group prompt. See the Configuration section or the person who configured the recorder for details.

1. Press [SET UP] key until:
Upper display = **ADJUST**
Lower display = **PRINTING**
2. Press [FUNC] key and TRACE LN appears in lower display.
3. Use [↑] or [↓] key to select dark, medium or light.
4. Press [FUNC] key and GRID LN appears in lower display.
5. Use [↑] or [↓] key to select dark, medium or light.
6. Press [FUNC] key and PEN TYPE appears in lower display.
7. Use [↑] or [↓] key to select "NORMAL". Note that the "JEWEL" selection is for a future enhancement and is not applicable at this time.
8. Press [LOWR DISP] key to return to normal operation and observe the change in printing characteristics.

6

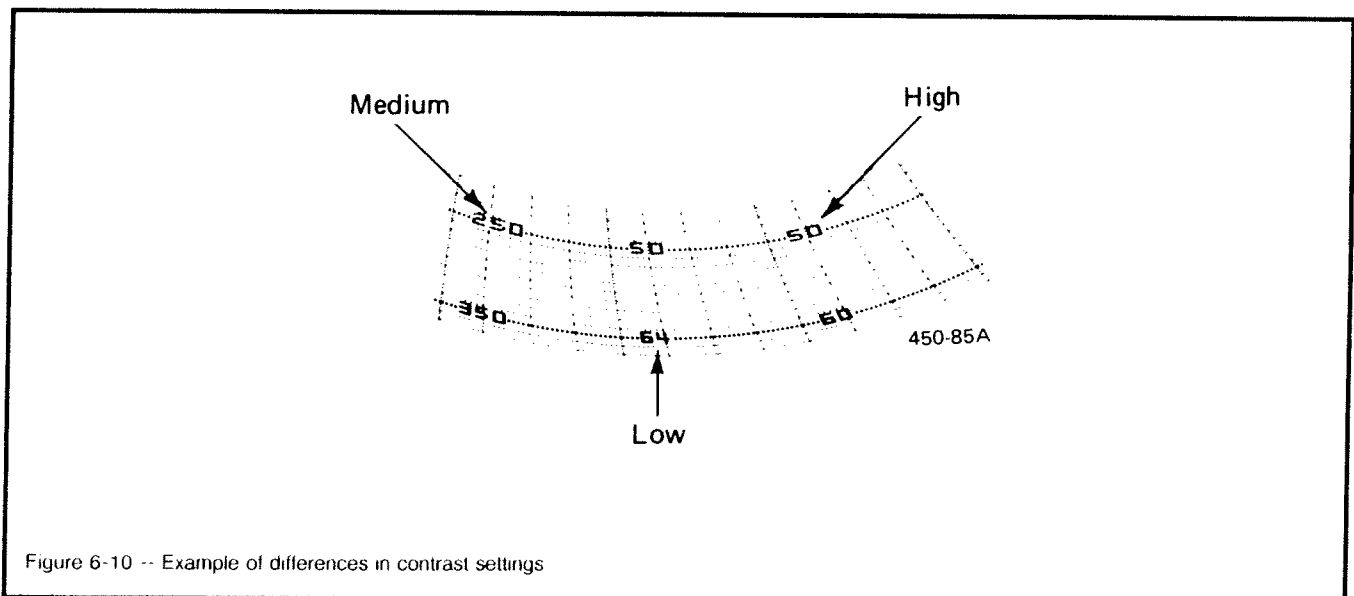

Figure 6-10 -- Example of differences in contrast settings

Service

Section 7

Summary

This section explains how to troubleshoot the DR 4500 recorder using self-diagnostic test results and error messages as well as some visual failure symptoms. Using an optimum replacement unit repair philosophy, trouble is traced to a printed circuit board (PCB)/hardware assembly level rather than to an individual PCB/hardware assembly component. While troubleshooting the DR 4500 is straightforward, we recommend that only trained service technicians repair the recorder.

Self-Diagnostics

The DR 4500 recorder runs self-diagnostic tests to monitor the recorder's general health. The tests are divided into these three main groups: Power-Up, Background, and Status. The power-up tests are run whenever power is cycled off and on, the background tests run continuously during normal operation, and the status tests run when initiated by the operator.

Customer Support

If you cannot find and/or repair the trouble using the procedures in this section, note the recorder's model and serial numbers (nameplate) and call Customer Support Phone Number:

1-800-423-9883

(between the hours of 7:30 am and 4:00 pm E.S.T.)

If it is determined that a hardware problem exists and the recorder is within the TWO-YEAR WARRANTY, a replacement recorder will be shipped with instructions for returning the defective one.



Troubleshooting

The troubleshooting procedures are divided into two parts: Error Message Prompts and Visual Failure Symptoms. If a 'FAILED' indication was given for one of the power-up tests and/or an error message prompt blinks in the lower display, refer to the Error Message Prompts part. If suspect operation is observed, refer to Visual Failure Symptoms part. In either case, run the following Status Test to verify the status of the recorder's basic self-diagnostic tests.

NOTE: Before troubleshooting hardware and software related problems, we recommend that you check for installation and application related problems. Refer to the Installation section to be sure that the recorder is installed properly. Check that the control and output algorithms are the right ones for your application.

Running Status Test

1. Press [SET UP] key until,
Upper display = **READ**
Lower display = **STATUS**
2. Press [FUNC] key:
Upper display = **(some number)**
Lower display = **VERSION**

NOTE: The number in the upper display represents the recorder's software version number -- you may want to record this for future reference.

3. Press [FUNC] key:
Upper display = **PASS** or **FAIL**
Lower display = **RAM TEST**
4. Press [FUNC] key:
Upper display = **PASS** or **FAIL**
Lower display = **CONFTEST**
5. Press [FUNC] key:
Upper display = **PASS** or **FAIL**
Lower display = **CAL TEST**
6. Press [FUNC] key:
Upper display = **PASS** or **FAIL**
Lower display = **FACT CRC**
7. If "FAIL" indication was given for any test, see Table 7-1 for suggested corrective action. Press [LOWR DISP] key to exit STATUS Test function, or press [FUNC] key to cycle through test again.

Error Message Prompts

The following Error Message Prompts appear during the power-up test or the status test, or they may blink in the lower display during normal operation. For troubleshooting purposes, power-up and status tests are assumed to be in a FAILED state.

TABLE 7-1 -- Error Message Prompts

Lower Display	Test Group	Reason for Failure	How to Correct the Problem
FAILSAFE	Status	Burnout configured for none and input fails. RAM TEST failed CONFTEST failed CALTEST failed	1. Check operation of input sensor. 2. Run STATUS test to identify particular failure.
RAM TEST	Power-up or Status	RAM failure	1. Cycle power to see if error clears.* 2. If error doesn't clear, replace main printed circuit board (PCB).

* NOTE: System noise induced into the recorder will result in diagnostic error messages recurring. If the diagnostic error messages can be cleared, it indicates a "soft" failure and is probably noise related. If system noise is suspected, completely isolate the recorder from all field wiring. Use calibration sources to simulate PV and check all controller functions, i.e., Gain, Rate, Reset, Output, etc.

TABLE 7-1 -- Error Message Prompts (continued)

Lower Display	Test Group	Reason for Failure	How to Correct the Problem
CONFTEST	Power-up or Status	Configuration data in recorder in error	<ol style="list-style-type: none"> 1. Check all configuration prompts for accuracy. See Configuration section. 2. Run Status Test -- Recorder will recalculate configuration checksum. 3. Replace main PCB.
CAL TEST	Power-up or Status	Working calibration constants in error	<ol style="list-style-type: none"> 1. If recorder has not been field calibrated -- see Configuration section and change input type to a different type. Enter it, run Status Test, and then return input type to original. 2. If recorder has been field calibrated, recalibrate the recorder. 3. Replace main PCB.
FACT CRC	Status	Factory-set input constants have changed due to a change in input type.	<ol style="list-style-type: none"> 1. Check calibration -- Be sure 0 and 100% values are correct. (See Calibration section.) 2. Recalibrate recorder. 3. Run Status Test to clear. 4. Replace main PCB.
E E FAIL	Background	Unable to write to non-volatile memory (Any time you change a parameter and it is not accepted, you will see E E FAIL.)	<ol style="list-style-type: none"> 1. Check accuracy of parameter; reenter. 2. Replace main PCB.
INP1FAIL	Background	Two consecutive failures of input one integration (i.e., cannot make analog to digital conversion)	<ol style="list-style-type: none"> 1. Be sure actuation is configured correctly; see Configuration section. 2. Be sure input is correct. 3. Be sure hardware configuration is correct. 4. Check for gross overranging or underranging. 5. Replace main PCB.
INP2FAIL INP3FAIL INP4FAIL	Background	Input 1, 2, 3, or 4 -- out of range. Process input is outside 0 to 100% region. <i>Out of range criteria:</i> Linear: $\pm 10\%$ Characterized: $\pm 1\%$	<ol style="list-style-type: none"> 1. Be sure range and actuation are configured correctly. 2. Check input source. 3. See configuration section and change input type to a different type. Enter it, run Status Test, and then return input to original. 4. Field calibrate -- see Calibration. 5. Replace main PCB.

7

TABLE 7-1 -- Error Message Prompts (continued)

Lower Display	Test Group	Reason for Failure	How to Correct the Problem
PV LIMIT	Background	Process Variable is out of range.	<ol style="list-style-type: none"> 1. Be sure pen input configuration is correct. 2. Check displayed PV value to see if it is outside input limits. 3. Replace main PCB.
RV LIMIT	Background	Result of formula shown below is beyond range of remote variable. $RV = IN2 \times RATIO + BIAS$	<ol style="list-style-type: none"> 1. Go to CONTROL prompt REMOTE SOURCE and change REMOTE to 1 LOCAL.

Visual Failure Symptoms

The following visual symptoms of failure identify some problems that you may observe during operation. Progressive steps provide aid in finding and fixing the problem.

SYMPTOM 1: Recorder will not operate

What to Do	How to Do It or Where to Find the Data
1. Check supply voltage.	1. Measure line voltage across connections to connector J9 on main PCB.
2. Check connections to J9 on main PCB.	2. Refer to "Wiring" in Installation section.
3. Check transformer leadwire connections to main PCB.	3. Refer to "Internal Cabling Data" figure in Parts List section.
4. Check electrical system for Brown-Outs, heavy load switching, etc. and for conformance to installation instructions.	4. Refer to Installation section.
5. Replace transformer.	5. Disconnect transformer leadwires from main PCB. Remove screws and transformer from case. Replace transformer and tighten screws. Connect leadwires to main PCB.
6. Replace main PCB.	6. Refer to Replacement Procedures in this section.

SYMPTOM 2: Recorder operation is normal but pen trace is incorrect

What to Do	How to Do It or Where to Find the Data
1. Check sensor for proper type and ability to function.	1. Verify input configuration data and operation of sensor.
2. Recalibrate recorder.	2. Refer to calibration section. For thermocouple input, be sure to confirm cold-junction temperature calibration.
3. Replace servo plate assembly.	3. Refer to Replacement Procedures in this section.
4. Replace main PCB.	4. Refer to Replacement Procedures in this section.

SYMPTOM 3: Chart rotates at wrong speed or will not rotate (pen indication correct)

What to Do	How to Do It or Where to Find the Data
1. Check chart installation.	1. Be sure drive pin on hub is in drive hole on chart.
2. Check configured chart speed value and change it, if required.	2. Refer to Configuration section.
3. Check motor cable plug connection at connector J4 on main PCB.	3. Visually examine plug and reset it.
4. Replace chart motor.	4. Refer to Replacement Procedure in this section.
5. Replace main PCB.	5. Refer to Replacement Procedures in this section.

SYMPTOM 4: Pen remains at high end of range when input signal is low

What to Do	How to Do It or Where to Find the Data
1. Check sensor and leadwires for continuity. Check connections.	1. Replace sensor or leadwires as needed. Tighten connections.
2. Check pen and input configuration data.	2. Refer to Configuration section.
3. Replace servo plate.	3. Refer to Replacement Procedures in this section.
4. Replace main PCB.	4. Refer to Replacement Procedures in this section.

SYMPTOM 5: Pen does not move when input signal changes

What to Do	How to Do It or Where to Find the Data
1. Check sensor and leadwires for continuity. Check connections.	1. Replace sensor or leadwires as needed. Verify and tighten input connections.
2. Check pen arm for secure mechanical attachment to servo shaft.	2. Refer to "Replacing the Pen Arm," in this section.
3. Check servo cable plug connection at connector on main PCB.	3. Visually examine plug and reseal it.
4. Replace servo plate.	4. Refer to Replacement Procedures in this section.
5. Replace main PCB.	5. Refer to Replacement Procedures in this section.

SYMPTOM 6: A key doesn't respond and/or a display doesn't light

What to Do	How to Do It or Where to Find the Data
1. Run Key Test to check operation of keys and displays.	1. Refer to Operation section for procedures on running Key Test.
2. Replace membrane switch (keyboard) and/or display PCB as required.	2. Refer to Replacement Procedures in this section.

7

SYMPTOM 7: Displayed output does not agree with controller output**(1) Current Proportional Output Type**

What to Do	How to Do It or Where to Find the Data
1. Be sure controller is configured for current output.	1. Check that OUT ALG selection = CURRENT. Refer to Configuration section.
2. Check field wiring.	2. Impedance must be less than or equal to 1000 ohms.
3. Be sure all controller related configuration data is correct.	3. Refer to Configuration section to check Tuning, Algorithm, and Control data.
4. Check output.	4. Put controller in Manual mode and raise/lower output manually from 0 to 100% (4-20 mA). Use milliammeter at connector J1 on control output PCB.
5. Recalibrate current proportional output.	5. Refer to Calibration section.
6. Replace control output PCB.	6. Refer to Replacement Procedures in this section.

(2) Position Proportional Output Type

What to Do	How to Do It or Where to Find the Data
1. Be sure controller is configured for Position Proportional output.	1. Check that OUT ALG selection = POSITN. Refer to Configuration section.
2. Check field wiring.	2. Refer to installation section.
3. Check output.	3. Put controller in manual mode and adjust output manually to drive motor from 0 to 100%.
4. Check whether motor drives in both directions. If it does, go to Step 5. If motor drives in one direction only, check slidewire. If motor doesn't drive in either direction, check motor.	4. Refer to Calibration section for motor slidewire calibration. Refer to motor instructions.
5. Check output voltage to slidewire.	5. Put voltmeter across slidewire terminals at connector J2 on control output PCB and check that slidewire voltage varies with motor position.
6. Be sure output relays are actuating properly. If they aren't, check field wiring; then go to Step 4. If they are, go to Step 7.	6. Put controller in manual mode and adjust output manually above and below present value. Listen for click of relays. One relay should click when output is adjusted higher, and other should click when output is adjusted lower than present value. Observe OUT 1 and 2 indicators on front display.
7. Check control relay jumper position.	7. Refer to Configuration section.
8. Replace control output PCB.	8. Refer to Replacement Procedures in this section.
9. Recalibrate position proportional output.	9. Refer to Calibration section.

(3) Single Relay or Dual Relay Output Type

What to Do	How to Do It or Where to Find the Data
1. Be sure controller is configured for relay output.	1. Check that OUT ALG selection = TIME. Refer to Configuration section.
2. Be sure all controller configuration data is correct.	2. Refer to Configuration section to check Tuning, Algorithm, and Control data.
3. Check that applicable output relay actuates properly. If it does, go to Step 4.	3. Put controller in manual mode and adjust output manually to raise and lower PV around SP. Listen for click of relay as PV moves in either direction. Observe OUT 1 or 2 indicator on front display.
4. Check control relay jumper positions.	4. Refer to Configuration section.
5. Check field wiring.	5. Refer to Installation section.
6. Replace control output PCB.	6. Refer to Replacement Procedures in this section.

(4) Duplex Current/Time or Time Current Proportional Output Type

What to Do	How to Do It or Where to Find the Data
1. Be sure controller is configured for Current/Time or Time/Current output.	1. Check that OUT ALG selection = TI CUR or CUR TI. Refer to Configuration section.
2. Be sure all controller configuration data is correct.	2. Refer to Configuration section to check Tuning, Algorithm, and Control data.
3. Check that applicable relay operates properly. If it does, go to Step 4. If it doesn't check field wiring; then go to Step 5.	3. Put controller into manual mode and adjust output manually to raise and lower PV around SP. Listen for click of relay as PV moves in either direction. Observe OUT 1 and 2 indicators on front display.
4. Check applicable control relay jumper position.	4. Refer to Configuration section.
5. Check current proportional output.	5. Put controller in manual mode and manually adjust output from 0 to 100% (4[20 mA). Use milliammeter across terminals in connector J1 on control output PCB to verify output.
6. Recalibrate current output.	6. Refer to Calibration section.
7. Replace control output PCB.	7. Refer to Replacement Procedures in this section.



SYMPTOM 8. External alarm function does not operate properly

What to Do	How to Do It or Where to Find the Data
1. Be sure all alarm configuration data is correct.	1. Refer to Configuration section.
2. Check applicable alarm relay jumper position.	2. Refer to Configuration section.
3. Check field wiring.	3. Refer to Installation section.
4. Check that applicable alarm relay actuates properly depending upon ALARM TYPE configuration selection.	4. Alarms can be triggered either by: - reconfiguring the value of the trip points (AnSnVAL), or by: - connecting a signal generator to the input and setting the generator level beyond the trip-point values.
5. Replace alarm output/digital input PCB.	5. Refer to Replacement Procedures in this section.

Replacement Procedures

The following procedures assume that the chart door is opened, the chart plate is swung out, and power is removed. Refer to the Parts List section for a general orientation regarding the location of components.

WARNING: Never access components inside the case with power applied.

Removing a Pen Arm, Part No. 30755315-001

NOTE: Be sure shipping sponge is installed on pen tip whenever recorder is moved or stored.

1. Open recorder door.
2. Press the [CHART] key. The pen arm will go to its outer limit and stop, and the prompt **CHT HOLD** will appear in the lower display.
3. Remove power from the recorder.
4. Loosen the slotted capscrew on the right side of the chart plate, and open the chart plate.

Removing a Pen Arm, Part No. 30755315-001 (continued)

5. Disconnect the stylus wire by removing the plug connector from J8 on the Main PCB (just above the large capacitor near the bottom of the board). Remove the wire ties from the connecting wires.
6. Remove pen cover.
7. Remove the screw that fastens the pen arm to the plastic sector gear on the servo shaft, and remove the pen arm from the shaft.

Replacing the Pen Arm

1. Place the pen arm on the plastic sector gear, and insert the attaching screw (removed in Step 5, above) into the sector gear, but do not tighten it completely.
2. Install a chart paper on the chart plate.
3. Loosen the slotted capscrew on the right side of the chart plate, and open the chart plate.
4. From the back of the chart plate, use finger pressure on the plastic sector gear to operate the pen arm toward the edge of the chart paper until the plastic sector gear comes to the limit stop.
5. Rotate the pen arm on the plastic sector gear so that the stylus is at the outer edge of the chart paper, and tighten the screw that attaches the pen arm to the sector screw.
6. Attach the connector plug at the end of the stylus wires to J8 (just above the large capacitor near the bottom of the Main PCB). Secure the wire with wire ties.
7. Close the chart plate, tighten the slotted screw, and close the recorder door.
8. Return the recorder to service as described in the Operation and Maintenance section of this manual.

Removing/Replacing Servo Plate Assembly, Part No. 30754975-503

1. Remove the pen arm as described previously under "Removing the Pen Arm."
2. Note how the spring is attached to the servo plate, and disconnect the spring from the servo plate.
3. Disconnect the cable plug for the pen motor from connector J7 on the Main PCB. Remove the cable from the clip on the chart plate.
4. Remove the screws that hold the servo plate to the chart plate, and remove the servo plate.
5. Attach the new servo plate and secure it with screws. Dress the cable in the clip and connect the plug to connector J7.
6. Replace the pen arm, removed in Step 1, as described previously under "Replacing the Pen Arm."

Removing/Replacing Chart Motor Part No. 30745974-501

1. Pull up the pen lifter to raise the pen from the chart, and remove the chart.
2. Disconnect the motor cable plug from J4 on the Main PCB and remove the cable from the clip on the chart plate.
3. Remove screws from the chart motor, and remove the motor.
4. Pull the hub off the chart motor and push it on the new motor.
5. Attach and secure the new motor with screws; dress the cable in the clip and connect the plug to J4 on the Main PCB.

Removing/Replacing Chart Motor Part No. 30745974-501 (continued)

6. Replace the chart, then push the pen lifter down.

Removing/Replacing Display PCB, Part No. 30755016-501

1. On the Display PCB, note the location of the ground connection wire, remove the screws from the PCB, and remove the PCB.
2. Disconnect plugs from connectors J2 (optional light), J2 (Main PCB), and J3 (keyboard) on the display PCB as applicable.
3. Ensuring that the ground wire is located as noted in Step 1, replace the PCB and secure it and the ground wire with screws.

Removing/Replacing Membrane Switch (Keyboard), Part No. 30754957-501

1. Disconnect the keyboard cable plug from connector J3 on the Display PCB. (Removing the Display PCB will facilitate plug removal; refer to Removing/Replacing Display PCB, given previously.)
2. Carefully pry the membrane switch from the front of the chart plate; pull the cable plug through the slot in the chart plate.
3. Feed the cable of the new membrane switch through the slot, and press the new membrane switch firmly into place so that the display is visible through the cutout.
4. Connect the keyboard cable plug to connector J3 on the Display PCB.

Removing/Replacing Main PCB, Part No. 30754999-502

1. Tag, then disconnect all cable plugs from connectors on the main PCB.
2. Remove nut and leads from the bolt in the lower-left corner of the Main PCB.
3. Remove the screws from the Main PCB, and remove the Main PCB from the case.
4. Replace the Main PCB and secure it with screws.
5. Replace the leads on the bolt in the lower-left corner of the PCB and tighten the nut. Reconnect the cable plugs, tagged in Step 1, to the connectors on the Main PCB.
6. Reconfigure and recalibrate the recorder. (Refer to the Configuration and Calibration sections of this manual.)

Removing/Replacing Control Output PCB, Part No. 30754922-501

1. Tag and disconnect all cable plugs from applicable control output PCB.
2. Note orientation of output PCB in card guides, and unplug it from mother PCB.
3. Compare position of relay contact jumpers on old PCB with those on new PCB and change as required. See Configuration section for jumper details.
4. Orient new output PCB as noted above, slide it in card guides, and press down firmly to seat connector on mother PCB.
5. Connect cable plugs as tagged in Step 1 to connectors on output PCB.
6. If control output is current or position proportional type, you may want to check calibration. See Calibration section in this manual.

Parts List

Section 8

Introduction

This list provides replacement parts for the DR 4500 Truline Recorder. Most parts are supplied on an optimum replacement unit basis; that is, part numbers are given for complete printed-circuit boards rather than for individual PCB components. When ordering parts, be sure to specify your recorder's serial and model numbers (nameplate) as well as the part identification.

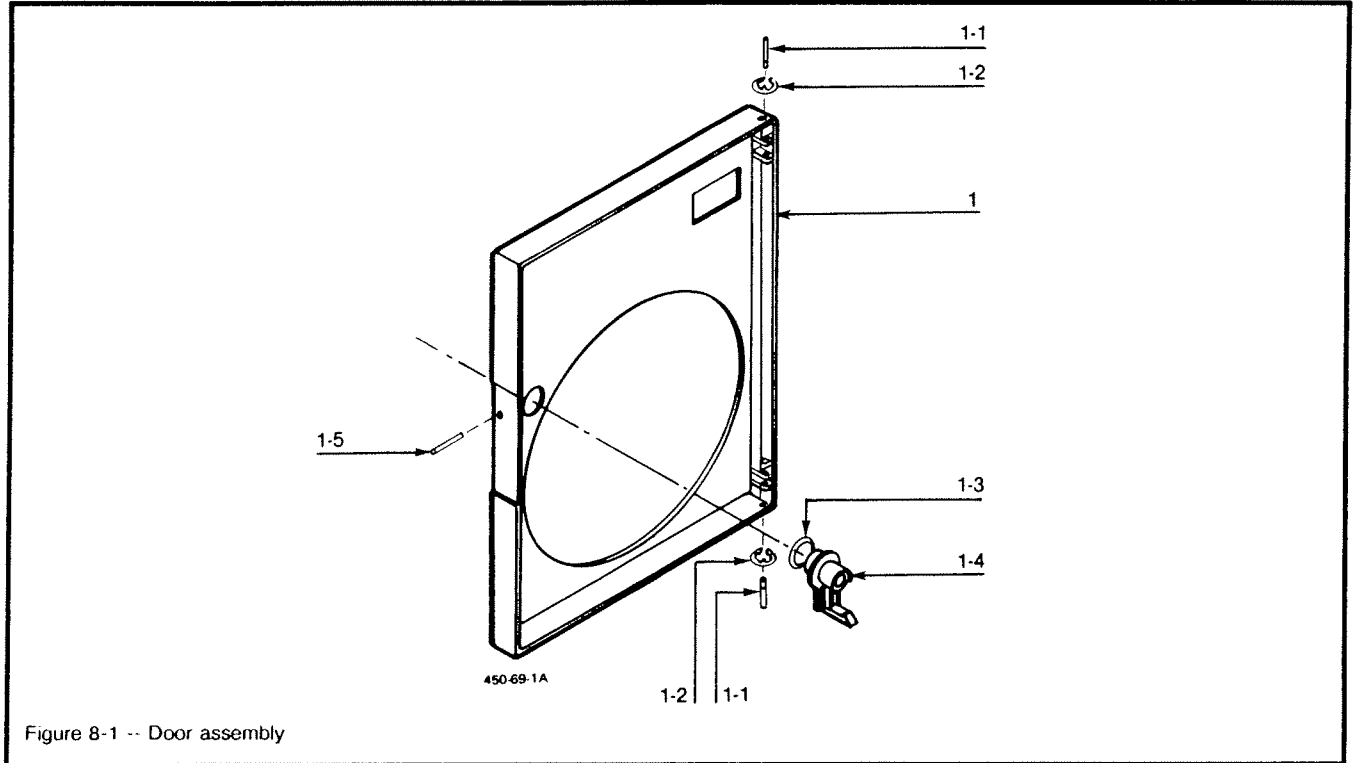

Figure 8-1 -- Door assembly

Key No.	Part Number	Description	Recomm'd Spare Parts per		Quantity per Unit
			10	100	
1	30754955-501 30754955-504 30756548-501 30756548-502	Door assembly -- with glass window and latch -- with acrylic window and latch -- with NEMA 4X with glass window and knob -- with NEMA 4X with acrylic window and knob			1
1-1	See Note 1	Hinge pin			2
1-2	See Note 1	Retaining ring			2
1-3	See Note 1	Latch gasket			1
1-4	See Note 1 & 1A	Latch (standard push type without lock)	1	3	1
1-5	See Note 1	Latch pin			1

NOTE 1: These parts are also included in the miscellaneous hardware kit 30755980-001.

NOTE 1A: To replace standard latch with knob type, order kit 30756584-001; for door lock order kit 30756584-002

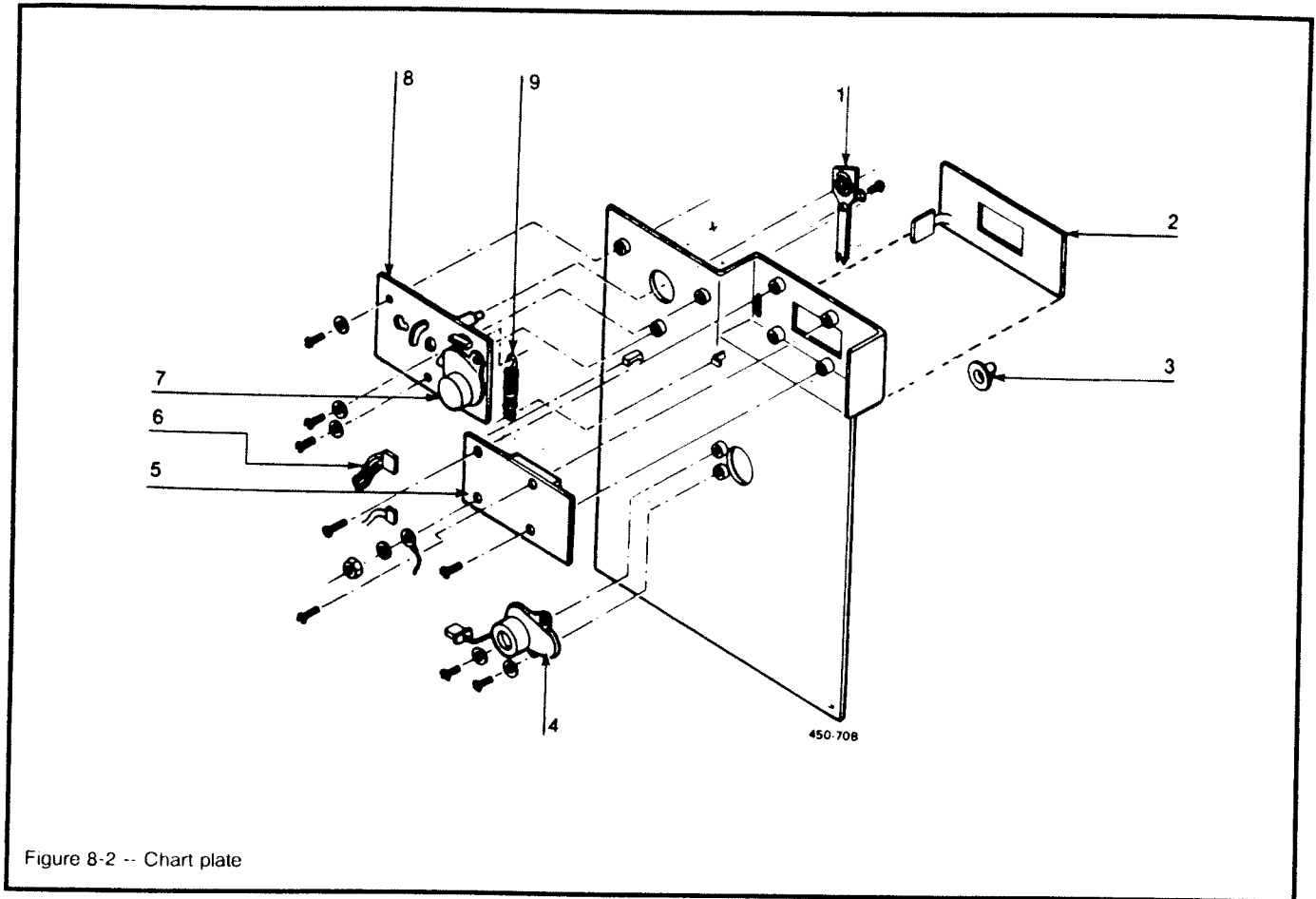

Figure 8-2 -- Chart plate

Key No.	Part Number	Description	Recomm'd Spare Parts per		Quantity per Unit
			10	100	
1	30756304-501	Truline pen arm assembly	1	5	1
2	30754957-501	Membrane switch	1	5	1
3	(K) 30756150-001	Chart hub kit (includes 2 hubs)	1	3	2
4	30754974-501	Chart motor	1	3	1
5	30755016-501	Display PCB (includes Key No. 6)	1	5	1
6	See above	Ribbon cable, display (included with Key No. 5)			1
7	See below	Servo motor assembly (included with Key No. 8)			
8	30754975-503	Servo plate assembly (includes Key No. 7)	1	2	1
9	(K) 30755980-002	Spring, tension			1

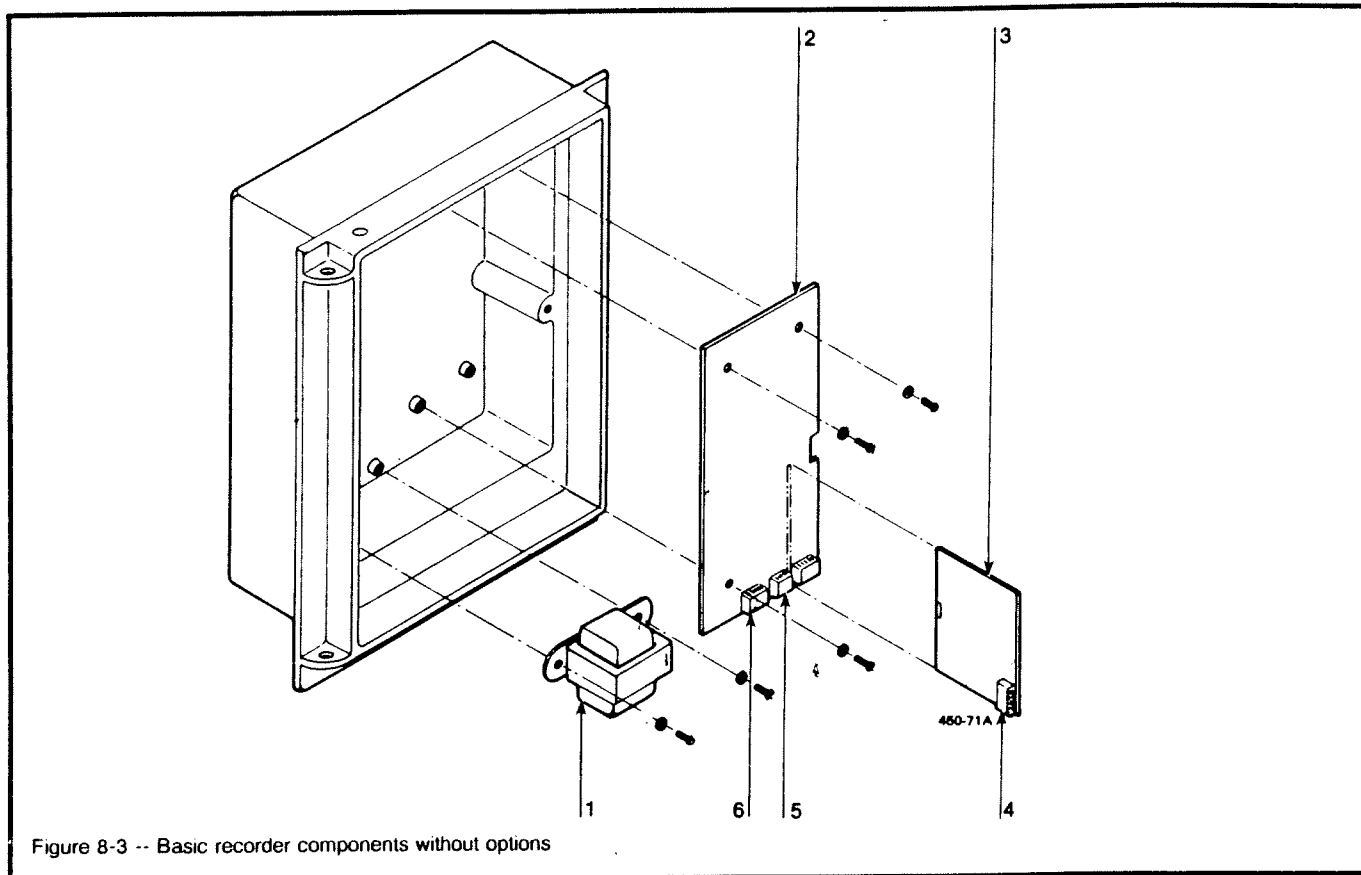

Figure 8-3 -- Basic recorder components without options

Key No.	Part Number	Description	Recomm'd Spare Parts per		Quantity per Unit
			10	100	
1	30754982-501	Transformer	1	3	1
2	30754999-502	Main PCB	1	5	1
3	(K) 30756141-001	Second input PCB (optional) kit			1/3
4	See Note 2	3-position connector**			2
5	See Note 2	2-position connector**			1
6	See Note 2	4-position connector**			1
PARTS NOT SHOWN					
	See Note 2	Card guides (second input (PCB)**)			2
	(K) 30756141-001	Current input resistor			*
	30755232-001	0-10 Vdc input divider (first input PCB)			*
	(K) 30756141-001	0-10 Vdc input divider (second input (PCB)			*
	(K) 30755065-001	Mounting kit			1
	(K) 30755134-001	Universal filler plate kit			*
	(K) 30755011-001	Filler panel kit (for replacing Servoline recorder)			*

NOTE 2: Parts included with applicable PCB kits, as required.

*As required

**These parts also included in the miscellaneous hardware kit 30755980-003

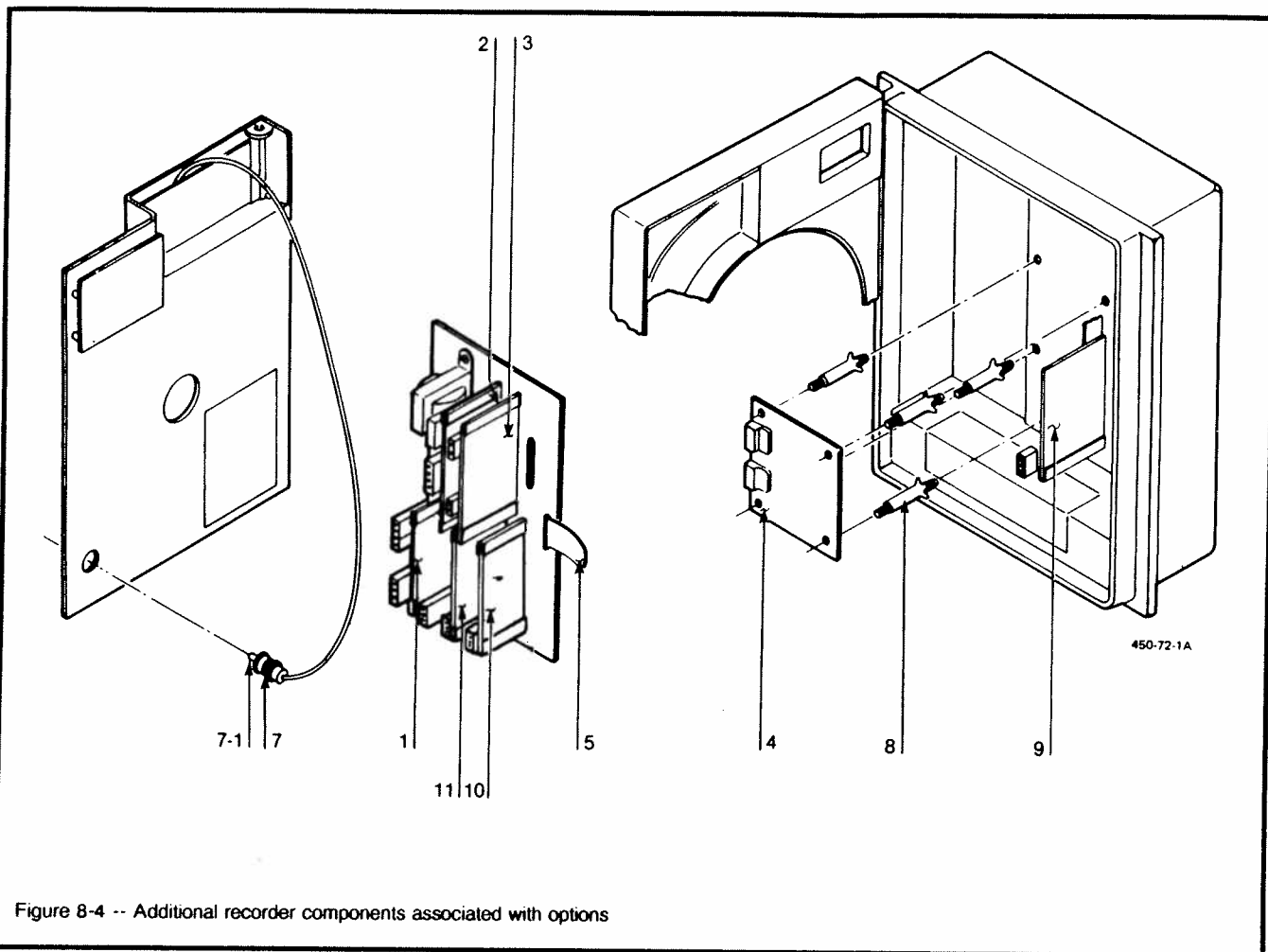

Key No.	Part Number	Description	Recomm'd Spare Parts per		Quantity per Unit
			10	100	
1	30754922-501	Second control output PCB			1
2	30754922-501	First control output PCB	1	5	1
3	30755009-001	DMCS communications PCB	1	5	1
4	(K) 30756140-001	Alarm output/digital input PCB kit			1
5	See Note 3 30755119-001	Ribbon cable (34 conductor)	1	3	1
7	30755127-501	Light accessory kit (includes Key No. 7.1)			1
7-1	See Above	Bulb (General Instrument 1828 or equivalent)			1
8	(K) 30756140-001	Spacer			4
9, 10, 11	(K) 30756141-001	Input PCBs: Second, third and fourth (optional)	1	5	1/3

NOTE 3: Part included with alarm output/digital input PCB kit 30756140-001.

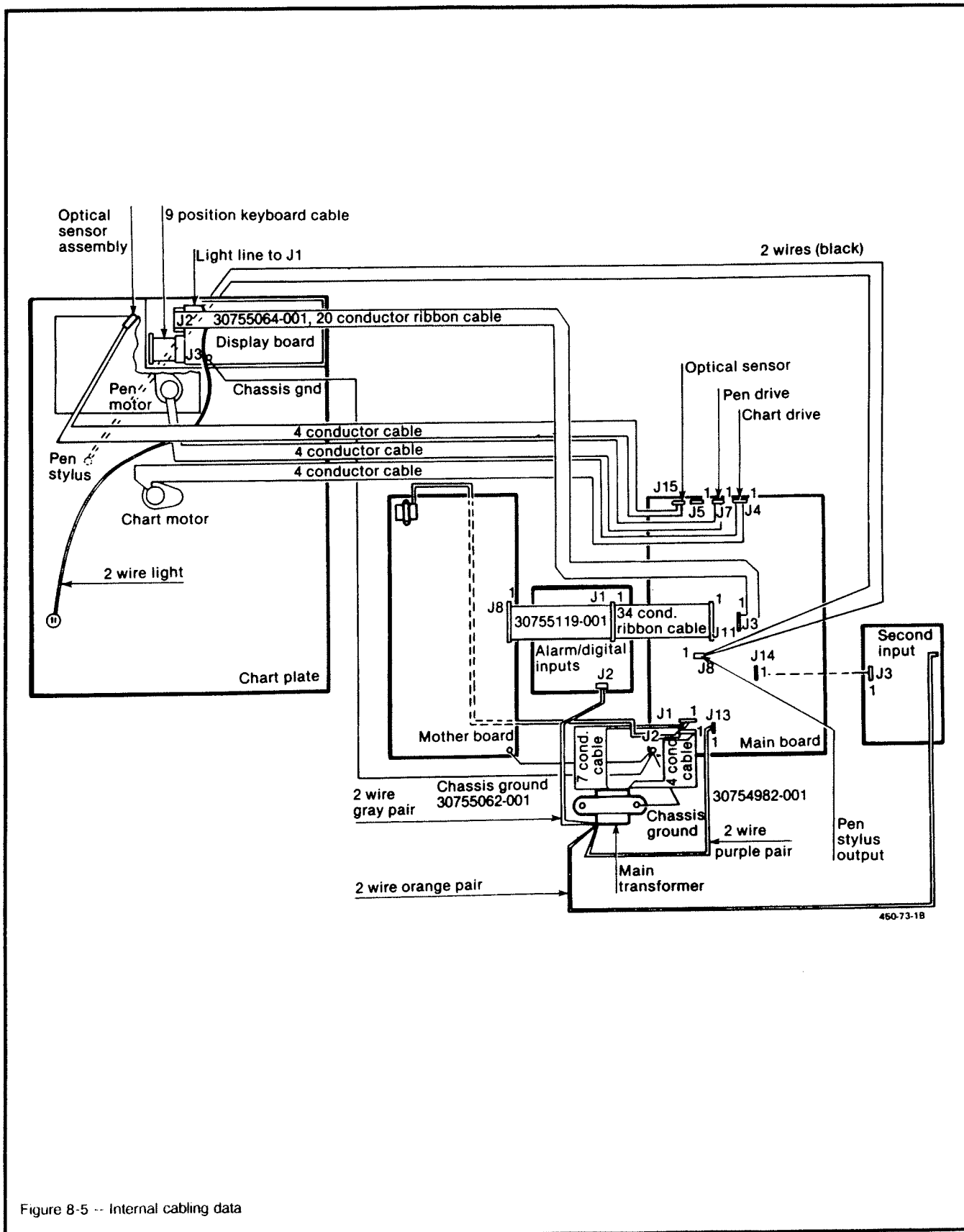

8

Figure 8-5 -- Internal cabling data

Reference Only**Miscellaneous Hardware Kit 30755980-TAB Contents**

Part Description	Quantity		
	001	002	003
Pen lifter/retainer		1	
Screw 10-32, 3/4" lg		5	
O-ring		5	
Spring, tension		2	
Hinge pin	2		
Retaining ring	2		
Pen arm #1 (Classic)		1	
Pen arm #2 (Classic)		1	
Latch without lock	1		
Latch pin	1		
Latch gasket	1		
Card guide			2
4-position connector			2
3-position connector			2
2-position connector			2

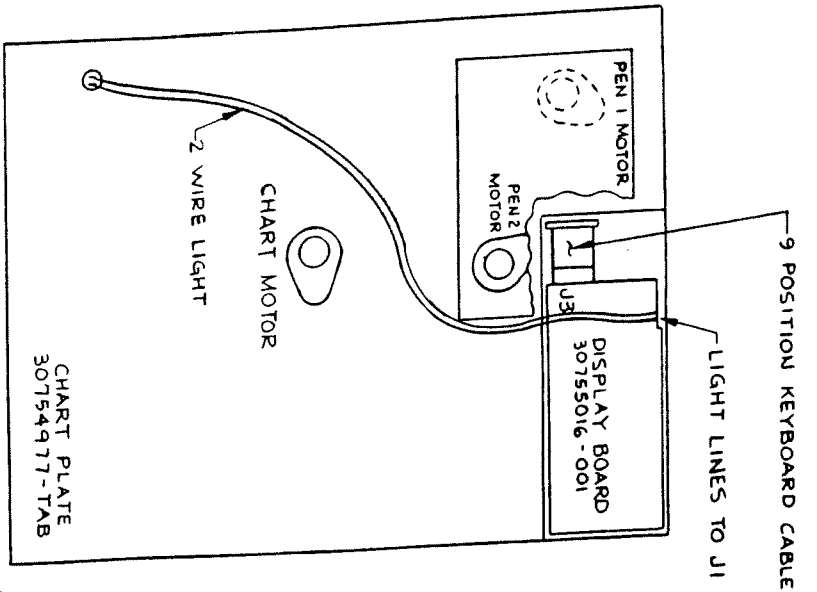
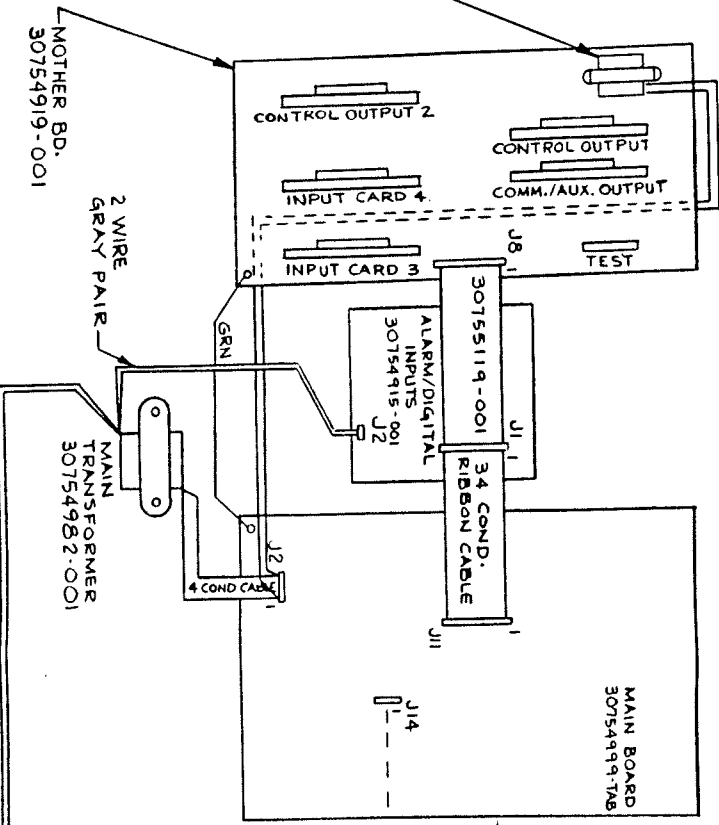

TABLE I
(SEE TABLE I FOR CONNECTIONS)

T.I. LEADS	NO. OF COND.	DESTINATION (BOARD)	CONN. DESIGNATION ON DESTINATION BD.
WHT	2	INPUT CARD #3	J1
BLU.	2	INPUT CARD #4	J1
BRN.	2	CONTROL OUTPUT #1	J4
ORG.	2	CONTROL OUTPUT #2	J4
VIO. GRAY	4	COMM. AUX. OUTPUT	J3 & J4
GRN. WHT. BLK. RED	4	MAIN BOARD	J2
GRN. WHT. BLK. RED	4	MAIN TRANSFORMER	FEMALE CONN. (GRN, WHT, BLK, RED.)



30755143-000

Honeywell

30755143-000

INTERNAL WIRING DIAGRAM
OPTIONS ONLY

REV 2 DATE 7/4/64 SHEET 5

Appendix A

Section 9

Introduction

This Appendix provides information for all the user configurable controller parameters listed in the configuration section. If you aren't familiar with these parameters, this appendix gives you the parameter prompt, the selection or range of setting that you can make, and a definition of how each parameter setting affects controller performance. It will also refer you to any other prompts that might be affected by your selection.

Parameter Groups and Prompts

As shown in the following Table of Contents, the controller information is found in 5 configuration groups which are accessed by pressing the [SET UP] key.

Each of these groups contains prompts, viewed in the lower display, which deal with functions that are pertinent to that particular group. These are accessed by pressing the [FUNC] key.

The selections or values are listed in the upper display. Refer to the Configuration section for step by step instructions.

Table of Contents

<u>GROUP</u>	<u>PAGE</u>
Tuning	9-2
Set Point Ramp	9-4
Control	9-5

TUNING PARAMETERS GROUP

Tuning Data

Lower Display

Upper Display

TUNING

SET-UP

Tuning consists of establishing the appropriate values for the tuning constants you are using so that your controller responds correctly to changes in process variable and set point. You can start with pre-determined values but you will have to watch the system to see how to modify them.

Parameter Definition	Lower Display Prompt	Upper Display Range of Setting or Selection
<p>PROPORTIONAL BAND is the percent of the range of the measured variable for which a proportional controller will produce a 100% change in its output.</p> <p>GAIN is the ratio of output change (%) to the measured variable change (%) that caused it.</p> <p>$G = \frac{100}{PB}$ where PB is the proportional band (in %)</p> <p>If the PB is 20%, then the Gain is 5. Likewise, a 3% change in the error signal (SP-PV) will result in a 15% change in the controller's output due to proportional action. If the gain is 2 then the PB is 50%. Defined as "HEAT" Gain on Duplex models for variations of Heat/Cool applications. The selection of Prop. Band or Gain is made in the control parameter group under Prompts "PBoRGAIn."</p>	<p>PROP-BD* or GAIN*</p>	<p>0.1 to 9999</p>
<p>RATE action affects the controller's output whenever the deviation is changing; and affects it more when the deviation is changing faster. Defined as "HEAT" Rate on Duplex models for variations of Heat/Cool applications.</p>	<p>RATE-MIN*</p>	<p>0.00 to 10.00 minutes 0.00 or Less = Off</p>
<p>RESET adjusts the controller's output in accordance with both the size of the deviation (SP-PV) and the time it lasts. The amount of the corrective action depends on the value of Gain. The Reset adjustment is measured as how many times proportional action is repeated/minute.</p> <p>Defined as "HEAT" Reset on Duplex models for variations of Heat/Cool applications. The selection of minutes per repeat or repeats per minute is made in the control parameters group under Prompt "MINorRPM."</p> <p>MANUAL RESET Only applicable if you have control algorithm PD WITH MANUAL RESET. Because a proportional controller will not necessarily line out at set point, there will be a deviation (offset) from set point. This eliminates the offset and lets the PV line out at set point.</p>	<p>RSET-MIN* or RSET-RPM* or MAN RSET**</p>	<p>0.02 to 50.00 0.02 to 50.00 - 100 to + 100 (in % output)</p>

*Used with Control Algorithm "PID-A" or "PID-B"

**Used with Control Algorithm "PD + MR"

**TUNING PARAMETERS GROUP
(continued)**

Lower Display Upper Display
TUNING SET-UP

Parameter Definition	Lower Display Prompt	Upper Display Range of Setting or Selection
<p>PROPORTIONAL BAND 2 or GAIN 2, RATE 2, and RESET 2 are the same as previously described except that they refer to the cool zone tuning constants on duplex models or the second set of PID parameters, whichever is pertinent.</p>	<p>PROP-BD2* or GAIN 2* RATE2MIN* RSET2MIN* or RST2RPM*</p>	<p>0.1 to 9999 0.00 to 10.00 minutes 0.00 or Less = Off 0.02 to 50.00</p>
<p>CYCLE TIME (HEAT) determines the length of one time proportional output relay cycle. Defined as "HEAT" cycle time for Heat/Cool applications.</p>	<p>CYC-SEC</p>	<p>1 to 120 seconds</p>
<p>CYCLE TIME 2 (COOL) is the same as above except it applies to Duplex models as the cycle time in the 'COOL' zone of Heat/Cool applications or for 2nd set of PID constants.</p>	<p>CYC2-SEC</p>	<p>1 to 120 seconds</p>

*Used with Control Algorithm "PID-A" or "PID-B"

SET POINT RAMP GROUP

Set Point Ramp

Lower Display Upper Display
SP RAMP **SET-UP**

A single set point ramp can be configured to occur between the current local set point and a final local set point over a time interval of from 1 to 255 minutes. You can start and stop the ramp using the RUN/HOLD key.*

Parameter Definition	Lower Display Prompt	Upper Display Range of Setting or Selection
<p>SET POINT RAMP -- make selection to enable or disable the set point ramp function. Make sure you configure a ramp time and a final set point value.</p> <p>ENABLE SET POINT RAMP -- Allows you to start the set point ramp (in automatic mode).</p> <p>DISABLE SET POINT RAMP -- Disables the set point ramp.</p>	<p>SP-RAMP</p>	<p>ENABLE</p> <p>DISABL</p>
<p>SET POINT RAMP TIME -- Enter the number of minutes desired to reach the final set point.</p>	<p>TIME-MIN</p>	<p>0 to 255 minutes</p>
<p>SET POINT RAMP FINAL SET POINT -- Enter the value desired for the final set point.</p> <p>NOTE: See Appendix C for set point ramp/soak program details.</p>	<p>FINAL-SP</p>	<p>Within SP limits</p>

*When you exit from [SET UP] mode, an "H" appears in the left-most PV display. This indicates that the set point ramp is enabled but in "Hold." Make sure the controller is in automatic mode and press the [RUN/HOLD] key to change to Run mode and the ramp will begin.

CONTROL PARAMETERS GROUP

Control Data

The functions listed in this group deal with how the DR 4500 will control the process including: Number of tuning parameter sets, Set point source, Power-up recall, Set point limits, Output direction and limits, Deadband and Hysteresis, Control algorithm, Output algorithm and the Current Duplex range.

Lower Display Upper Display
CONTROL SET-UP

Parameter Definition	Lower Display Prompt	Upper Display Range of Setting or Selection
<p>NUMBER OF TUNING PARAMETER SETS -- This selection lets you choose one or two sets of tuning constants (gain, rate, and reset).</p> <p>ONE SET ONLY -- Only one set of tuning parameters is available. Configure the values for: Gain (proportional band) Rate Reset Cycle (if time proportional is used)</p> <p>TWO SETS KEYBOARD SELECTABLE -- Two sets of tuning parameters can be configured. Press [LOWR DISP] key to prompt "TUN 1/2" to switch between sets. Configure the values for: Gain Gain #2 Rate Rate #2 Reset Reset #2 Cycle Cycle #2</p> <p>TWO SETS PV AUTOMATIC SWITCHOVER -- When the process variable is <i>GREATER</i> than the value set at prompt "SW VALUE" (Switchover Value), the controller will use Gain, Rate, Reset, and Cycle. When the process is <i>LESS</i> than the value set at prompt "SW VALUE," the controller will use Gain#2, Rate#2, Reset#2, and Cycle#2. <i>Other prompt affected:</i> SW VALUE</p> <p>TWO SETS SP AUTOMATIC SWITCHOVER -- When the set point is <i>GREATER</i> than the value set at prompt "SW VALUE" (Switchover Value), the controller will use Gain, Rate, Reset, and Cycle. When the set point is <i>LESS</i> than the value set at prompt 'SW VALUE," the controller will use Gain#2, Rate#2, Reset#2, and Cycle#2. <i>Other prompt affected:</i> SW VALUE</p>	<p>PID SETS</p>	<p>1 ONLY</p> <p>2KEYBD</p> <p>2PV SW</p> <p>2SP SW</p>
<p>AUTOMATIC SWITCHOVER VALUE -- This is the value of Process Variable or Set Point at which the controller will switch from Tuning Constant Set#2 to Set#1.</p>	<p>SW VALUE</p>	<p>VALUE IN ENGINEERING UNITS</p>

**CONTROL PARAMETERS GROUP
(continued)**

Lower Display Upper Display
CONTROL SET-UP

Parameter Definition	Lower Display Prompt	Upper Display Range of Setting or Selection
<p>SET POINT SOURCE -- This selection determines what your set point source will be; One local, Remote, or Two local-key toggled.</p> <p>LOCAL SET POINT -- The set point entered from the keyboard.</p> <p>REMOTE SET POINT -- A signal is brought in through the second input PCB connector J2 and used as the control #1 set point. Ratio and Bias can be applied to the remote set point.</p> <p><i>Other Prompts affected: RATIO, BIAS</i></p> <p>NOTE: If recorder has two controllers (both enabled), the remote set point signal for controller #1 is brought in through the third input PCB connector J2 and used as the control #1 set point; and the remote set point signal for controller #2 is brought in through the fourth input PCB connector J2 and used as the control #2 set point.</p>	<p>SP SOURCE</p>	<p>1LOCAL REMOTE</p>
<p>TWO LOCAL SET POINTS -- This selection lets you switch between two local set points.</p> <p>RATIO -- Used when input 2* operates as a remote set point, prompt "REMOTE." This ratio value can be applied to the remote set point. It establishes the correct relationship between the remote set point and the input #2 signal applied according to the formula below . . .</p>	<p>RATIO</p>	<p>2LOCAL -20.00 to 20.00</p>
<p>BIAS -- Used when input #2 operates as a remote set point prompt "REMOTE." Bias, together with ratio, establishes the correct relationship between the remote set point and the input 2* signal applied according to the formula:</p> <p style="padding-left: 40px;">$(RATIO \times INPUT\ 2^*) + BIAS = REMOTE\ SET\ POINT$</p>	<p>BIAS</p>	<p>-9999 to 9999 Engineering Units</p>

*For recorder with two controllers, use input 3 for controller #1 and input 4 for controller #2.

**CONTROL PARAMETERS GROUP
(continued)**

Lower Display Upper Display
CONTROL SET-UP

Parameter Definition	Lower Display Prompt	Upper Display Range of Setting or Selection
<p>SET POINT TRACKING -- Select one of the following:</p> <p>NO TRACKING -- If local set point tracking is not configured, the LSP will not be altered when transfer from RSP to LSP is made.</p> <p>LSP (LOCAL SET POINT) TRACKS RSP (REMOTE SET POINT) IN RSP -- If configured, when the controller transfers out of remote set point, the last value of the remote set point (RSP) is inserted into the local set point.</p>	<p>SP TRACK</p>	<p>NONE</p> <p>RSP</p>
<p>POWER UP CONTROLLER MODE RECALL -- Restart after power loss. Select one of the below:</p> <p>MANUAL, LSP -- At power-up, the controller will use manual mode with the output value displayed.</p> <p>AUTOMATIC, LOCAL SET POINT -- At power-up, the controller will return to the auto mode and will use the local set point for control.</p> <p>AUTOMATIC, REMOTE SET POINT -- At power-up, the controller will return to the Automatic mode, and the last selected set point.</p>	<p>POWER UP</p>	<p>MANUAL</p> <p>A LSP</p> <p>A RSP</p>
<p>SET POINT HIGH LIMIT* -- This selection prevents the local and remote set points from going above the value selected here. The setting must be equal or less than the upper range of input 1 and input 2,* when configured for remote set point, will be restricted to this upper limit.</p>	<p>SP HILIM</p>	<p>0 to 100% of span Input in engineering units with decimal place</p>
<p>SET POINT LOW LIMIT* -- This selection prevents the local and remote set points from going below the value selected here. The setting must be equal or greater than the lower range of input 1 and input 2. Input 2,* when configured for remote set point, will be restricted to this lower limit.</p>	<p>SP LOLIM</p>	<p>0 to 100% of span Input in engineering units with decimal place</p>

*The Local Set Point will automatically adjust itself to be within the set point limit range. For example, if SP = 1500 and the SP HILIM is changed to 1200, the new Local Set Point will be 1200.

*Applies for Input 3 and Input 4 for recorder with two controllers.

**CONTROL PARAMETERS GROUP
(continued)**

Lower Display Upper Display

CONTROL SET-UP

Parameter Definition	Lower Display Prompt	Upper Display Range of Setting or Selection
<p>CONTROL OUTPUT DIRECTION -- What direction do you want the controller output to go when the process variable increases?</p> <p>DIRECT ACTING CONTROL -- The controller's output <i>increases</i> as the process variable increases.</p> <p>REVERSE ACTING CONTROL -- The controller's output <i>decreases</i> as the process variable increases.</p>	ACTION	<p>DIRECT</p> <p>REVRSE</p>
<p>HIGH OUTPUT LIMIT -- This is the highest value of output beyond which you do not want the controller automatic output to exceed. Use 0 to 100% for time proportional output type.</p>	OUTHILIM	-5 to 105% of output
<p>LOW OUTPUT LIMIT -- This is the lowest value of output below which you do not want the controller automatic output to exceed. Use 0 to 100% for time proportional output type.</p>	OUTLOLIM	-5 to 105% of output
<p>CONTROLLER DROPOFF VALUE -- Select an output value that below which the controller output will dropoff to the low output limit value set in prompt "OUT LOLIM."</p>	DROPOFF	-5 to 105% of output
<p>DEADBAND is an adjustable gap between the operating ranges of output 1 and output 2. It is the difference between the nominal trip points of relay 1 and relay 2.</p>	DEADBAND	-5.0 to 25.0%
<p>HYSTERESIS (OUTPUT RELAY ONLY) is an adjustable overlap of the ON/OFF states of each relay. This is the difference between the value of the process variable at which the control relay(s) energize and the value at which they de-energize. Only applicable for Position Proportional and ON-OFF control.</p>	OUT HYST	0.0 to 5.0% of PV span
<p>FAILSAFE OUTPUT VALUE -- Select the value you want the output to be when power is returned after a power-down. The value used here will also be the output level when you have Communications SHED or when No Burnout is configured and input 1 fails.</p>	FAILSAFE	With the range of output limits
<p>PROPORTIONAL BAND UNITS -- Select one of the following:</p> <p>PROPORTIONAL BAND -- Selects units of percent proportional band for the P term of the PID algorithm.</p> <p>GAIN selects the unitless term of gain for the P term of the PID algorithm.</p>	PBorGAIN	<p>PB PCT</p> <p>GAIN</p>
<p>RESET UNITS -- Selects units of minutes or repeat per minutes for the I term of the PID algorithm. 20 Repeats per minute = 0.05</p> <p>REPEATS PER MINUTE -- The number of times per minute that the proportional action is repeated by reset.</p> <p>MINUTES PER REPEAT -- The time between each repeat of the proportional action by Reset -- the reciprocal of repeats per minute.</p>	MINorRPM	<p>RPM</p> <p>MIN</p>

CONTROL PARAMETERS GROUP
(continued)

Lower Display Upper Display

CONTROL SET-UP

Parameter Definition	Lower Display Prompt	Upper Display Range of Setting or Selection
<p>The CONTROL ALGORITHM lets you select the type of control that is best for your process.</p> <p>NOTE: If recorder has two controllers (both enabled), CONT1ALG applies for controller #1 and CONT2ALG applies for controller #2.</p> <p>ON/OFF is the simplest control type. The output can be either ON (100%) or OFF (0%). The Process Variable (PV) is compared with the set point (SP) to determine the sign of the error (ERROR = PV-SP). The ON/OFF algorithm operates on the sign of the error signal.</p> <p>In Direct Acting Control, when the error signal is positive, the output is 100%; and when the error signal is negative the output is 0%. If the control action is reverse, the opposite is true. An adjustable overlap (Hysteresis Band) is provided between the on and off states.</p> <p>DUPLEX ON/OFF is an extension of this algorithm when the output is configured for Relay Duplex. It allows the operation of a second ON/OFF output. There is a deadband between the switching points of the relays and a hysteresis band for the one and off states of each relay. Both Deadband and Hysteresis are separately adjustable. With no relay action the controller will read 50%.</p> <p>PID A is normally used for three-mode control. This means that the output can be adjusted somewhere between 100% and 0%. It applies all three control actions -- Proportional (P), Integral (I), and Derivative (D) -- to the error signal.</p> <p>Proportional (Gain) -- regulates the controller's output in proportion to the error signal (the difference between Process Variable and Set Point).</p> <p>Integral (Reset) -- regulates the controller's output proportional to the size of the error and the time the error has existed (the amount of corrective action depends on the value of proportional Gain).</p> <p>Derivative (Rate) -- regulates the controller's output in proportion to the rate of change of the error (the amount of corrective action depends on the value of proportional Gain).</p> <p>PID B unlike the PID-A equation, the controller gives only an integral response to a set point change, with no effect on the output due to the gain or rate action, and it gives full response to PV changes. Otherwise controller action is as described for the PID-A equation.</p>	<p>CONT-ALG</p>	<p>ON-OFF</p> <p>PID A</p> <p>PID-B</p>

**CONTROL PARAMETERS GROUP
(continued)**

Lower Display Upper Display
CONTROL SET-UP

Parameter Definition	Lower Display Prompt	Upper Display Range of Setting or Selection
<p>RELAY DUPLEX -- Type of output using two SPST relays. Its normally open (NO) or normally closed (NC) contacts are selected by positioning an internal jumper for each relay. (See Hardware Configuration.) <i>Other prompts affected:</i> "DEADBAND" and "OUT HYST"</p> <p>CURRENT/RELAY DUPLEX (RELAY = HEAT) is a variation of duplex with current active for 0 to 50% output (tuning set 2) and relay active 50 to 100% output (tuning set 1). <i>Other prompts affected:</i> "OUT HYST," "4-20 RNG," "DEADBAND"</p> <p>CURRENT/RELAY DUPLEX (RELAY = COOL) is similar to "CUR-TI" except that current is active for 50 to 100% and relay is active for 0 to 50%. <i>Other prompts affected:</i> "OUT HYST," "4-20 RNG," "DEADBAND"</p>	<p>OUT-ALG (continued)</p>	<p>TIME D</p> <p>CUR-TI</p> <p>TI-CUR</p>
<p>DUPLEX RANGE ALGORITHM -- Used with Output Algorithm selections "CUR-TI" or "TI-CUR."</p> <p>CURRENT RELAY DUPLEX RANGE (SPLIT) enables the control current output to provide its full range for 50% output change. If "CUR-TI" duplex was selected, the current output provides cool control. To enable this, the 4-20 RNG output must be set for 50 PCT.</p> <p>CURRENT RELAY DUPLEX RANGE (FULL) enables the control current output to provide duplex heat control over 0-100% output change and the relay output to provide cool control. To enable this, the 4-20 RNG output must be set for 100%.</p>	<p>4-20 RNG</p>	<p>50 PCT</p> <p>100 PCT</p>

Appendix B Manual Tuning

Section 10

Introduction

When you tune a controller, there are some things to consider:

- Process Characteristics -- Gain (PB), Time, Constants, etc.
- Desired Response -- Minimal overshoot

Basically, controller tuning consists of determining the appropriate values for the Gain (PB), Rate (Derivative), and Reset (Integral) Time tuning parameters (control constants) that will give the control you want. Depending on the characteristics of the deviation of the process variable from the set point, the tuning parameters interact to alter the controller's output and produce changes in the value of the process variable. Since each parameter responds to a specific characteristic of the deviation, you may not need a combination of all three. It depends on the process characteristics and the desired control response.

You can estimate a starting point and the tuning parameters required to give the desired controller response and with some experience become proficient with this method.

An alternate approach is to rely on a tuning technique. In practice, tuning techniques usually do not give exactly the type of response desired; thus, some final adjustments to the tuning parameters must be made. However, you should at least obtain a reasonable starting point from which the desired response characteristics can be obtained.

The tuning method presented here requires finding the Gain (PB) of a proportional-only controller that will cause the loop to cycle indefinitely with a constant amplitude. This Gain (PB) is called the ultimate (measured) Gain (PB).

- Tune out all rate and reset time action, and put the controller into automatic mode,
- Introduce an upset into the loop, and adjust the Gain (PB) until the loop cycles continuously,
- Record the value of Gain or PB and the period of time for one oscillation of the process variable (measured time),
- Determine the setting from the table of formulas given in the procedure.

Controller Tuning Procedures

There are three procedures for tuning the controller:

- Time, Position, or Current proportional control,
- Duplex time proportional control
- Two sets of tuning constants for single output operation.

The suggested procedures describe how to establish and store values of Gain (PB), Rate, and Reset time constants for your process. You must know the type of control and algorithm you have configured.

Time, Position, or Current Proportional Control

Procedure

STEP 1

In Manual Mode, adjust the output to bring the PV (Process Variable) near the desired value. When obtaining HEAT tuning parameters, the output must remain above 50% (to obtain COOL tuning parameters see the procedure for Duplex Time Proportional Control).

STEP 2

Set Rate Time to 0 minutes and set Reset Time to maximum value (50.00 minutes) to minimize Reset action.

If applicable, set CYCLE TIME to 2 seconds and DEADBAND to 0.5.

STEP 3

Increase GAIN (decrease PB) significantly. Try a factor of 10.

STEP 4

Adjust the local set point to equal PV and switch to automatic control mode.

STEP 5

Increase the Set Point by 5 or 10% and observe the process variable response.

STEP 6

If the PV oscillates, continue to the next step. If it doesn't oscillate, return to the original Set Point and increase GAIN (decrease PB) again by a factor of 2, and repeat step 5.

STEP 7

Compare the oscillations with Figure 10-1 shown below.

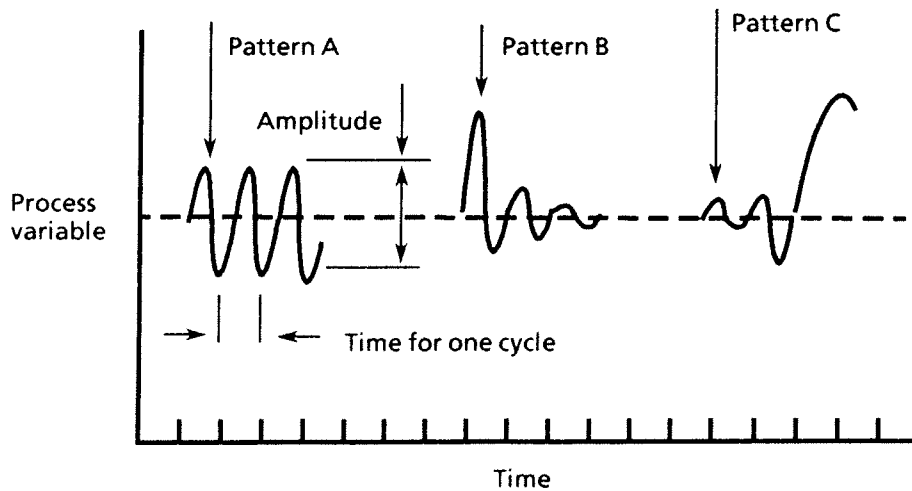

Figure 10-1 -- Pen trace patterns after a set point step change

STEP 7 (continued)

- If the oscillation matches pattern A, go to STEP 8.
- If the oscillation matches pattern B, increase GAIN (decrease PB) by a factor of 2 and repeat steps 4 to 6.
- If the oscillation matches pattern C, decrease GIN (increase PB) by a factor of 0.8 and repeat steps 4 to 6.

The amplitude of the cycle is immaterial, but all of the elements of the loop must be within the operating range (i.e., the valve must not go full open or full closed).

STEP 8

Record the current value of GAIN (or PB) and measure and record the value of time for one complete oscillation of PV.

STEP 9

Select the proper set of formulas from the Table 10-1. Use the values of GAIN (or PB) and time (in minutes) in the formulas to arrive at the controller's tuning parameters settings.

TABLE 10-1 -- Formulas

	Units	
	GAIN and RESET TIME in $\frac{\text{Minutes}}{\text{Repeat}}$	% PROPORTIONAL BAND and RESET ACTION in $\frac{\text{Repeats}}{\text{Minutes}}$
Proportional (P), only	GAIN = Measured Gain \times 0.5 RESET TIME = 50.00 (minimum reset) RATE = 0	%PB = Measured PB \times 2 RESET ACTION = 0.02 (repeats/minute) RATE = 0
Proportional + Reset (PI) (No Rate)	GAIN = Measured Gain \times 0.45 RESET TIME = $\frac{\text{Measured Time}}{1.2}$ (M/R) RATE = 0	%PB = Measured PB \times 2.2 RESET ACTION = $\frac{1.2}{\text{Measured Time}}$ (R/M) RATE = 0
Proportional + Reset + Rate (PID)	GAIN = Measured Gain \times 0.6 RESET TIME = $\frac{\text{Measured Time}}{2}$ RATE = $\frac{\text{Measured Time}}{8}$	%PB = Measured PB \times 1.7 RESET ACTION = $\frac{2}{\text{Measured Time}}$ RATE = $\frac{\text{Measured Time}}{8}$

STEP 10

Enter the values of GAIN (or PB), RATE, and RESET in Minutes (or Repeats per minute) into the DR 4500 and verify that the PV response is adequate.

- If you are using a proportional controller with manual reset, compare the pen trace with those in Figure 10-2 to determine if any further fine-tuning is required.
- If you are using a proportional controller plus reset, and/or plus rate, compare the pen traces to those in Figure 10-3 to determine if any further fine-tuning is required.

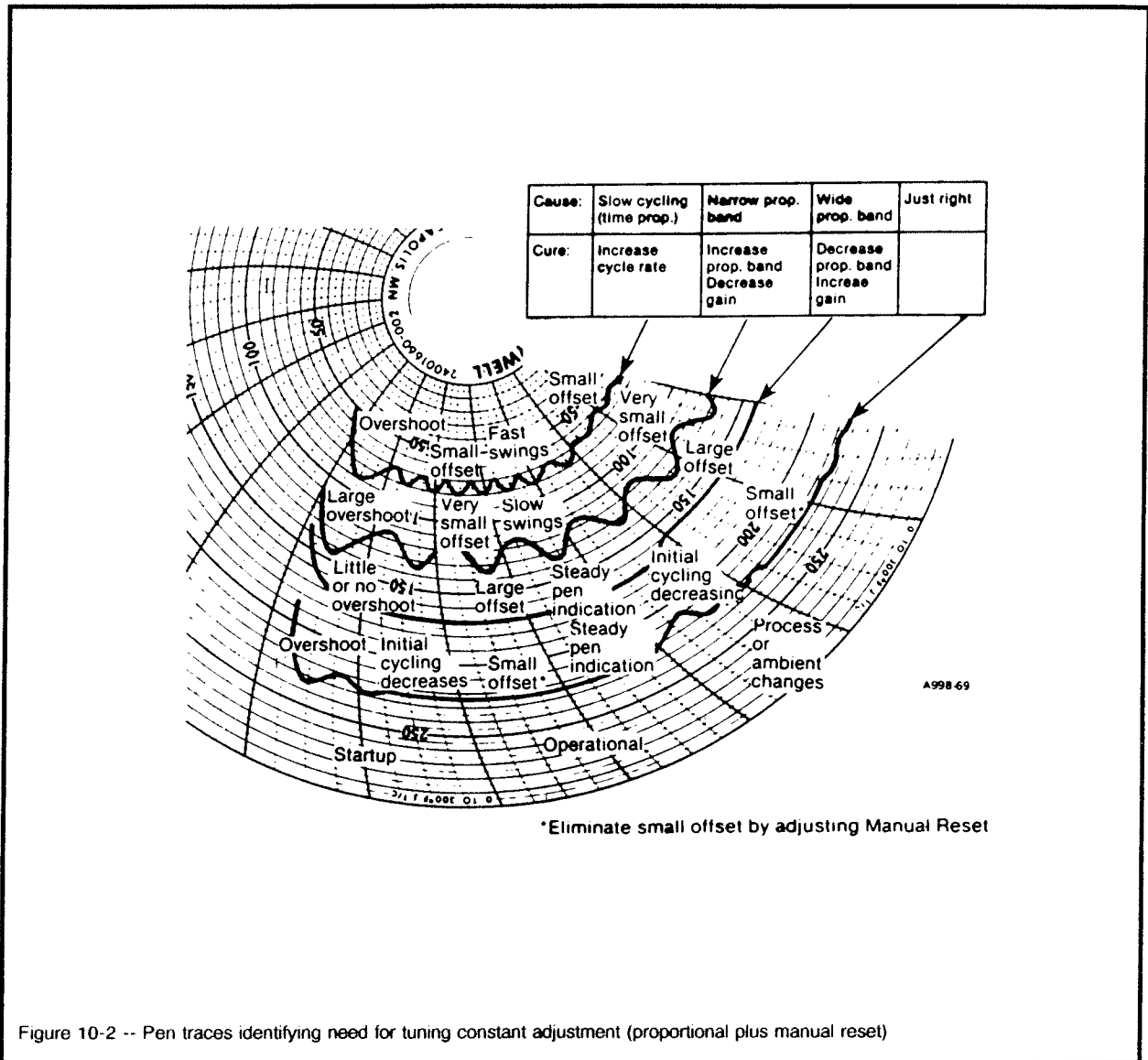

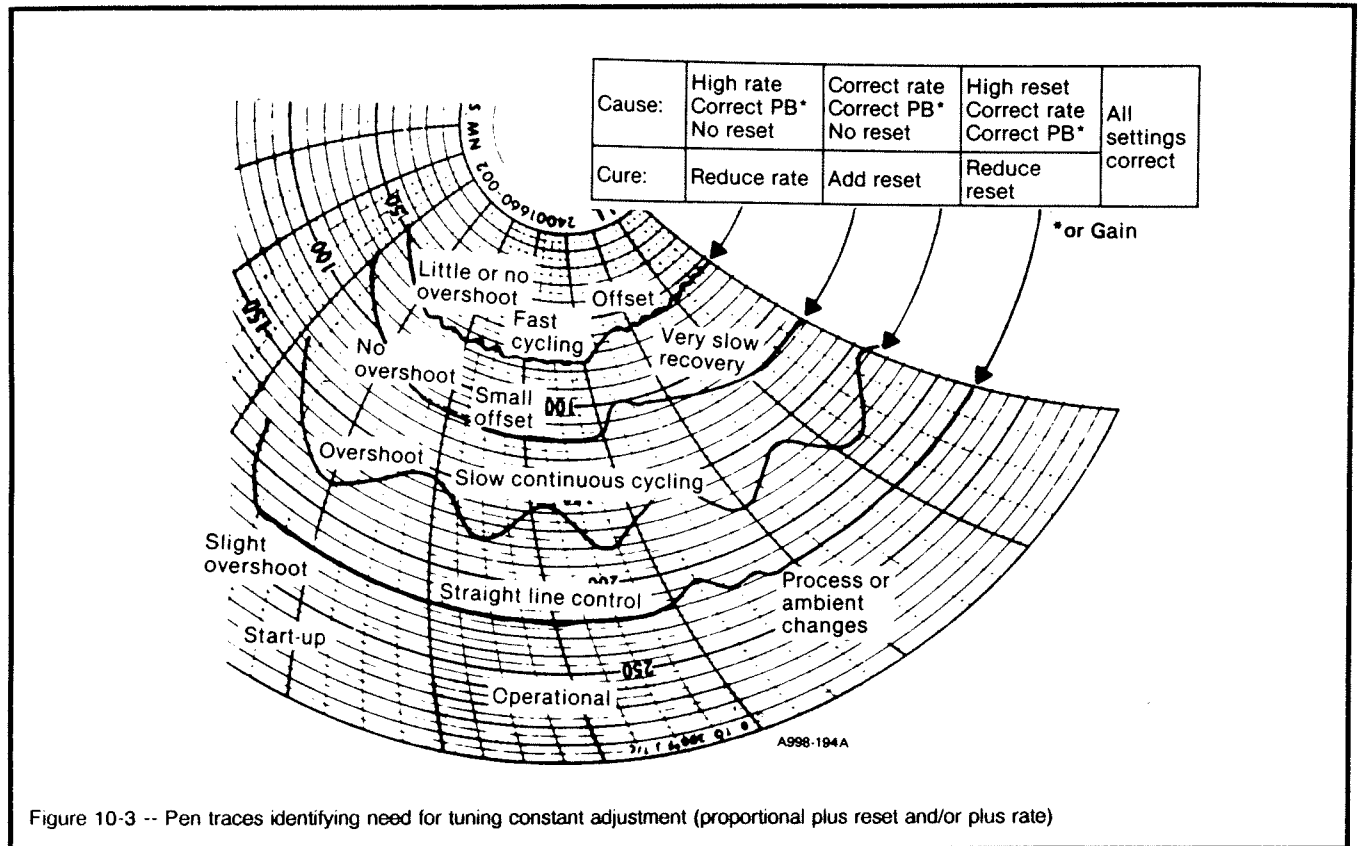

Duplex Time Proportional Control

For HEAT/COOL applications, tune the controller with the output above 50% for HEAT and below 50% for COOL.

The "TUNING" function prompts for HEAT/COOL are:

<u>HEAT</u>	<u>COOL</u>
GAIN	GAIN2
RESET	RESET2
RATE	RATE2
CYCLE	CYCLE2

Two Sets of Tuning Parameters for Single Output Operation

You can use two sets of tuning constants for single output types and tune each set separately.

The "TUNING" function prompts for two sets are:

<u>PID SET 1</u>	<u>PID SET 2</u>
GAIN	GAIN2
RESET	RESET2
RATE	RATE2
CYCLE	CYCLE2

Appendix C Set Point Ramp/Soak Programming

Section 11

Introduction

The term “Programming” is being used here to identify the process for selecting and entering the individual ramp and soak segment data needed to generate the required Set Point versus Time profile (also called a program).

A segment is a ramp or soak function which together make up a set point program. Set Point Ramp/Soak Programming lets you configure 6 ramp and 6 soak segments to be stored for use as one program or several small programs. You designate the beginning and end segments to determine where the program is to start and stop.

Each ramp segment can be configured to be run in hours and minutes or degrees per minute. 0 implies an immediate step change in set point to the next soak.

Each soak segment can have a guaranteed soak deviation which guarantees the value for each soak. This means that the timer will not start until the process variable (PV) is within the deviation limit (\pm) and then if the PV subsequently exceeds the deviation range, the timer holds until the PV enters the range.

Configuration

What You Will Configure

Basically, you will configure all the data that is relevant to each ramp and soak segment for a given set point versus time profile. The controller will prompt you through the sequence of segments and associated functions. These will include:

RAMP TIME

A ramp segment is the time it will take to change the set point to the next set point value in the program.

Ramps are odd number segments. Segment #1 will be the initial ramp time. Ramp time is determined in either

TIME*
Hours : Minutes
Range 0-99 hrs : 59 min

Enter value

	X	X	Y	Y	
--	---	---	---	---	--

where XX = hours (0-99)
YY = minutes (0-59)

or

RATE*
Degrees/Minute
Range 0 to 999

Enter value

		X	X	X	
--	--	---	---	---	--

where XXX = degrees/minute

*This selection of time or rate is made at prompt “RAMP UNIT.”

NOTE: Entering 0 will imply an immediate step change in set point to the next soak.

SOAK SET POINT RANGE VALUES AND DURATION TIME

A soak segment is a combination of soak set point (value) and a soak duration (time).

Soaks are even number segments.

Segment 2 will be the initial soak value and soak time.

The soak set point range value must be within the set point high and low range limits in engineering units.

SOAK TIME is the duration of the soak and is determined in

TIME
Hours : Minutes
Range 0-99 hrs : 59 min

Enter value

	X	X	Y	Y	
--	---	---	---	---	--

where XX = hours (0-99)

YY = minutes (0-59)

START SEGMENT NUMBER

This designates the number of the beginning segment.

The range is 1 to 11.

END SEGMENT NUMBER

This designates the number of the end segment. It must be a soak segment (even number).

The range is 2 to 12.

RECYCLE NUMBER

This number allows the program to cycle a specified number of times from beginning to end.

The range is 0 to 99.

SOAK DEVIATION

Each soak segment can have a deviation (\pm 0-99) which guarantees the value for that segment.

Guaranteed soak segments do not start timing soak duration until the process variable is within a selected \pm deviation from set point.

Unguaranteed soak segments start timing soak duration as soon as the soak set point is first reached, regardless of where the process variable remains relative to the soak segment.

The value is the number in engineering units, above or below the set point, outside of which the timer halts.

The decimal location corresponds to input 1 decimal selection.

The value 0 indicates no guaranteed soak value.

PROGRAM STATE

This selection determines the program state after completion.

DISABL = Disabled

HOLD = Program on hold

PROGRAM TERMINATION STATE

This function determines the status of the program following a power loss.

LAST SP = Hold at the last set point in the program

F SAFE = Manual mode, Failsafe output

RAMP UNIT

This determines the engineering units for the ramp segments.

TIME = Hours : Minutes

RATE = Degrees/Minute

Drawing a Ramp/Soak Profile

Before you do the actual configuration, we recommend that you draw a Ramp/Soak profile in the space provided on the Program Record Sheet and fill in the associated information. An example of a Ramp/Soak profile is shown on page 12-4.

Ramp/Soak Profile Example

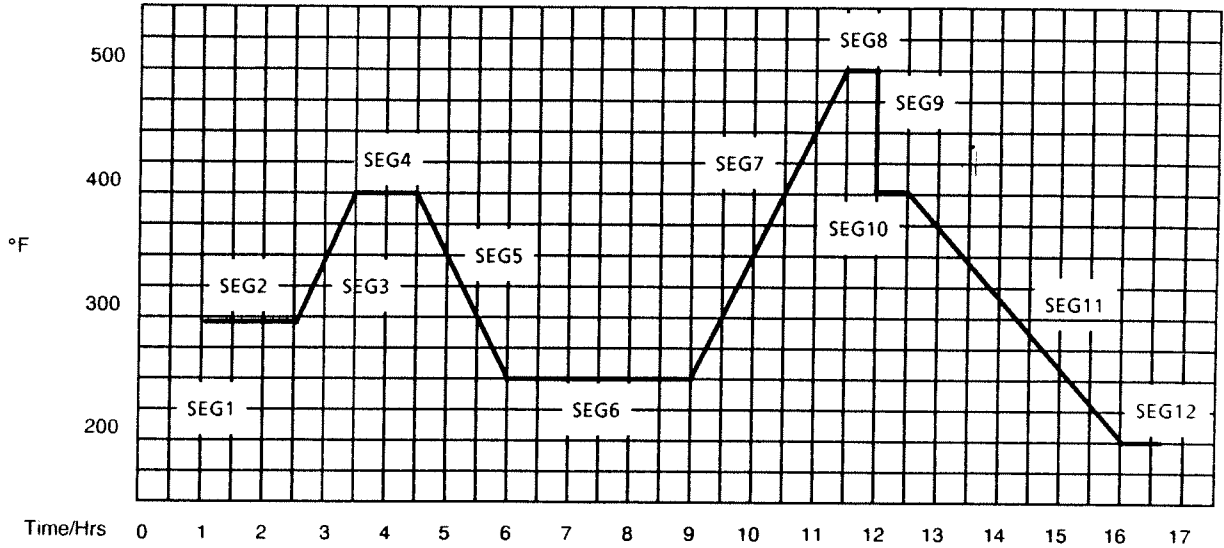

Prompt	Function	Segment	Value	Prompt	Function	Segment	Value
STRT SEG	Start Seg		1	SEG7RAMP	Ramp Time	7	2HR/30MN
END SEG	End Seg		12	SEG8 SP	Soak SP	8	500
RECYCLES	Number of Recycles		2	SEG8TIME	Soak Time	8	30 MIN
SOAK DEV	Deviation Value		0	SEG9RAMP	Ramp Time	9	0
SEG1RAMP	Ramp Time	1	1 HR	SG10 SP	Soak SP	10	400
SEG2 SP	Soak SP	2	300	SG10TIME	Soak Time	10	30 MIN
SEG2TIME	Soak Time	2	1HR/30MIN	SG11RAMP	Ramp Time	11	3HR/30MN
SEG3RAMP	Ramp Time	3	1 HR	SG12 SP	Soak SP	12	200
SEG4 SP	Soak SP	4	400	SG12TIME	Soak Time	12	30 MIN
SEG4TIME	Soak Time	4	1 HR	PROG END	Power Off State		LAST SP
SEG5RAMP	Ramp Time	5	1HR/30MIN	STATE	Program State		HOLD
SEG6 SP	Soak SP	6	250	RAMPUNIT	Engr. Unit for Ramp		TIME
SEG6TIME	Soak Time	6	3 HRS				

**Appendix D
Model DR 450R**

Section 12

Introduction

If the Key Number for your recorder is DR 450R, it is a relay expansion model Truline recorder which can have up to six alarm relay outputs and include an F_0 calculation function. While its basic functions are identical to the standard (DR 450T) Truline recorder, it does have some unique hardware, wiring, and configuration features. This instruction provides data pertinent to these unique features as a supplement to the standard Truline data in this Product Manual.

1. Hardware Identification

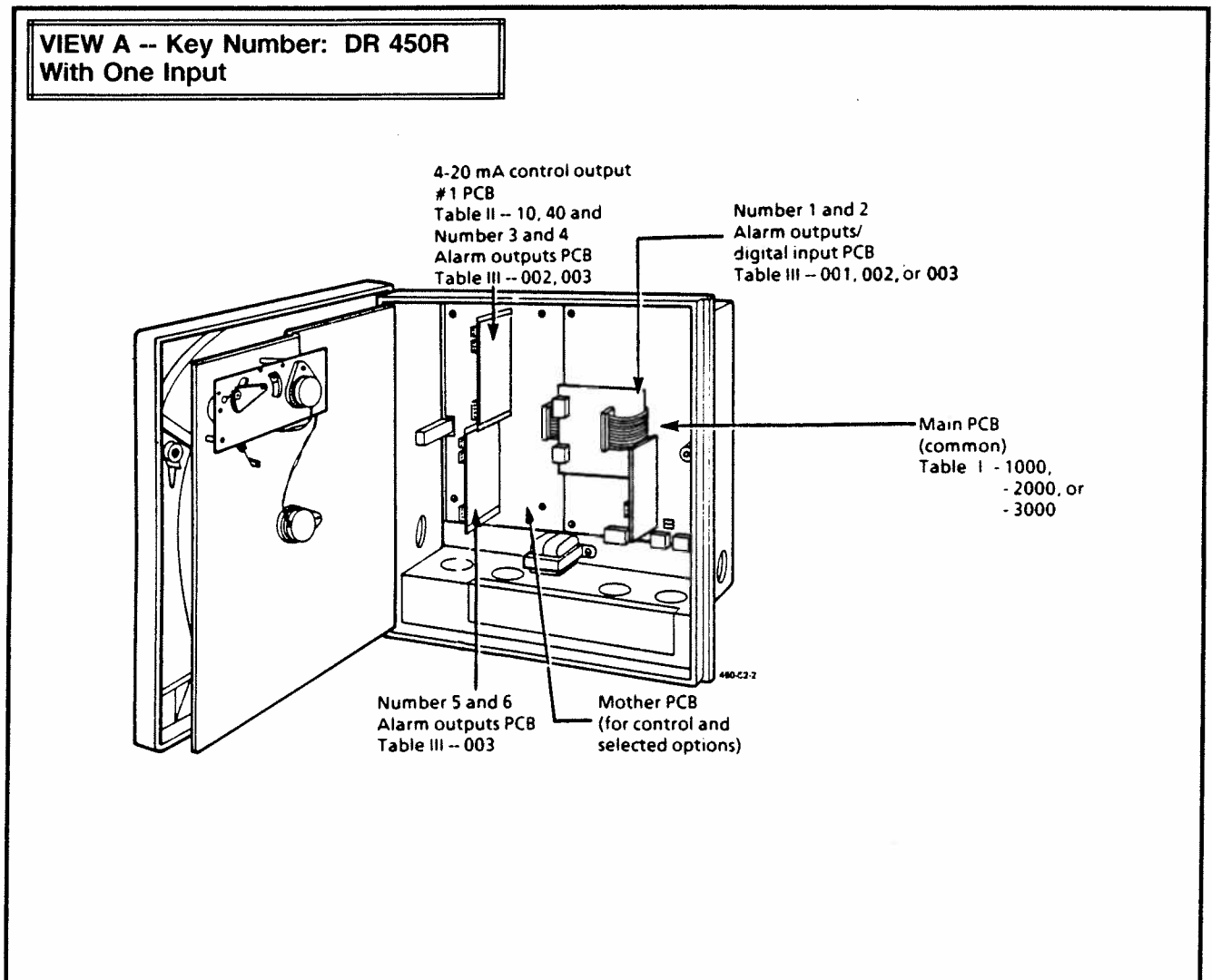

Figure D1-1 -- DR 450R Recorder hardware components versus "Table" selections.

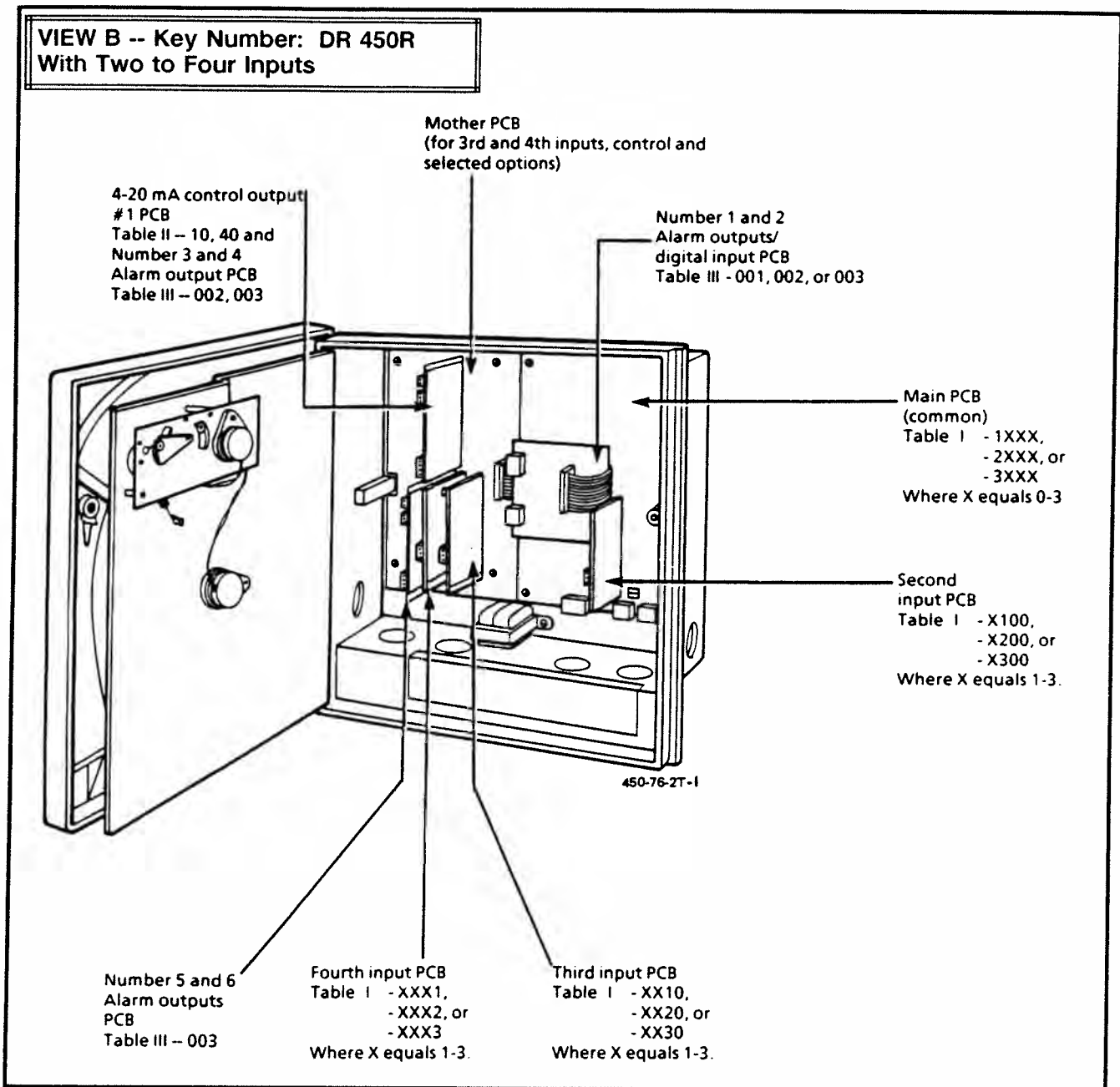

Figure D1-1 -- DR 450R Recorder hardware components versus "Table" selections -- Continued.

2. Wiring Addition

G. Connecting No. 3, 4, 5 & 6 Alarm Outputs & Digital Inputs

- Prerequisites:**
- Key Number = DR 450R
 - Table III = 002 (4 outputs) and 003 (6 alarm outputs)
 - Door and chart plate are opened

No. 3 and 4 Alarm Outputs (002, 003)

1. Locate connector J5 on 4-20 mA control output PCB to wire relays #3 and #4.
2. Remove unwired plug from J5.
3. Locate jumper position W2/W3 and W4/W5 below connector J5 on PCB. Note that you may want to remove plug-in output PCB for better access to jumpers. Be sure to tag and remove all plug connections to PCB before removing it. Position jumpers as shown for desired relay contact action and reinstall PCB.
4. Run alarm output wires through desired knockouts.
5. Strip 1/4-inch of insulation from end of each wire.
6. Loosen screws in plug J5 terminals and position plug as you would to plug it into J5.
7. Insert wires for alarm devices into screw clamps as shown. Tighten screws to secure wires.
8. Install wired plug into J5.

No. 5 and 6 Alarm Outputs (003)

1. Locate connector J5 on No. 5 and 6 alarm outputs PCB.
2. Remove unwired plug from J5.
3. Locate jumper positions W2/W3 and W4/W5 below connector J5 on PCB. Note that you may want to remove plug-in output PCB for better access to jumpers. Be sure to tag and remove all plug connections to PCB before removing it. Position jumpers as shown for desired relay contact action and reinstall PCB.
4. Run alarm output wires through desired knockout.
5. Strip 1/4-inch of insulation from end of each wire.
6. Loosen screws in plug J5 terminals and position plug as you would to plug it into J5.
7. Insert wires for alarm devices into appropriate screw clamps as shown. Tighten screws to secure wires.
8. Install wired plug into J5.

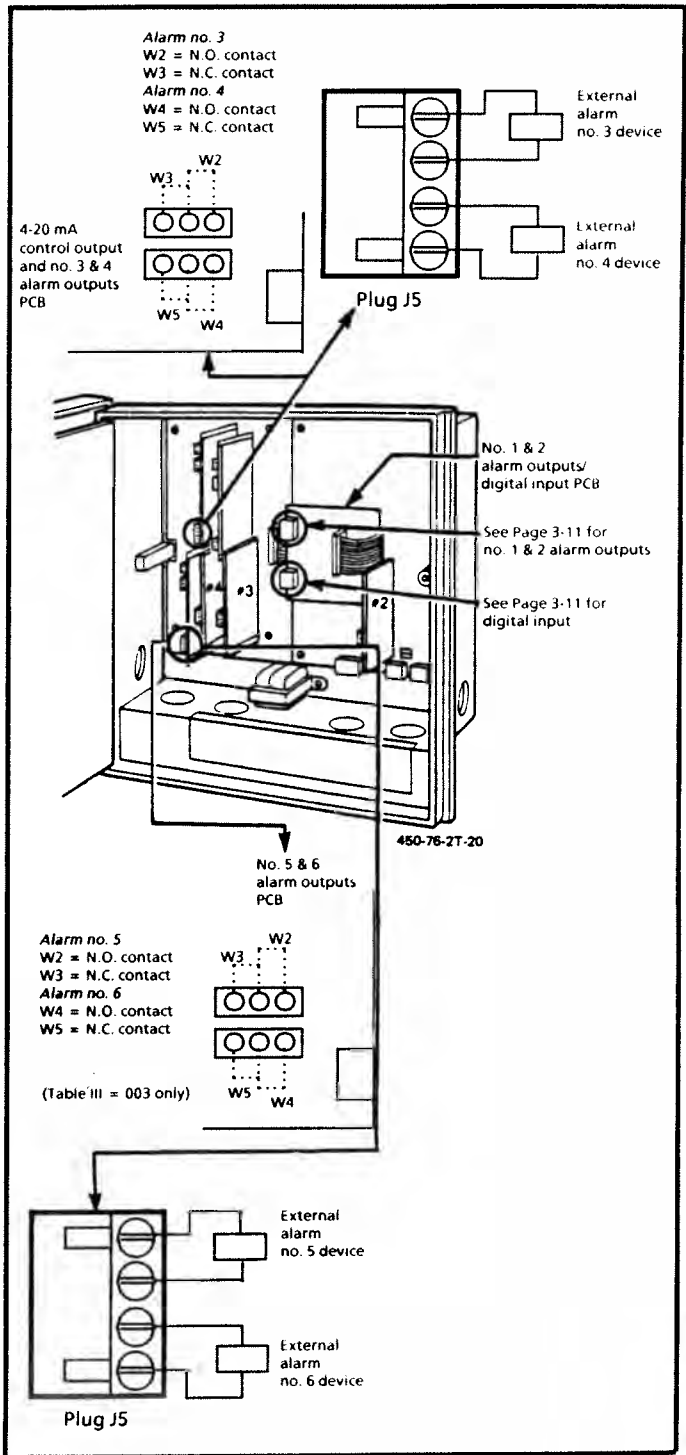

3. Prompt Hierarchy Changes

Figure D4-1 -- PROMPT HIERARCHY

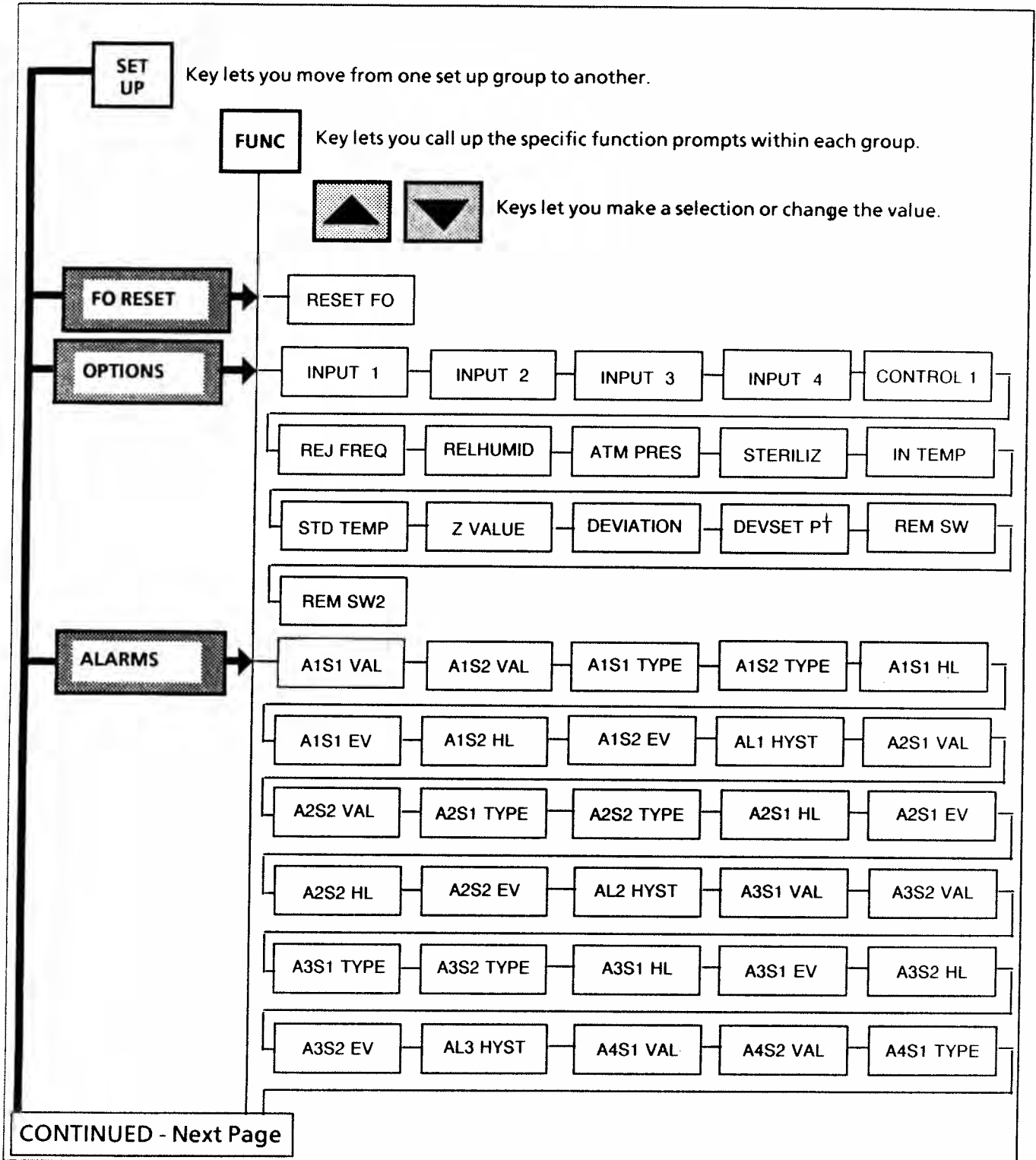
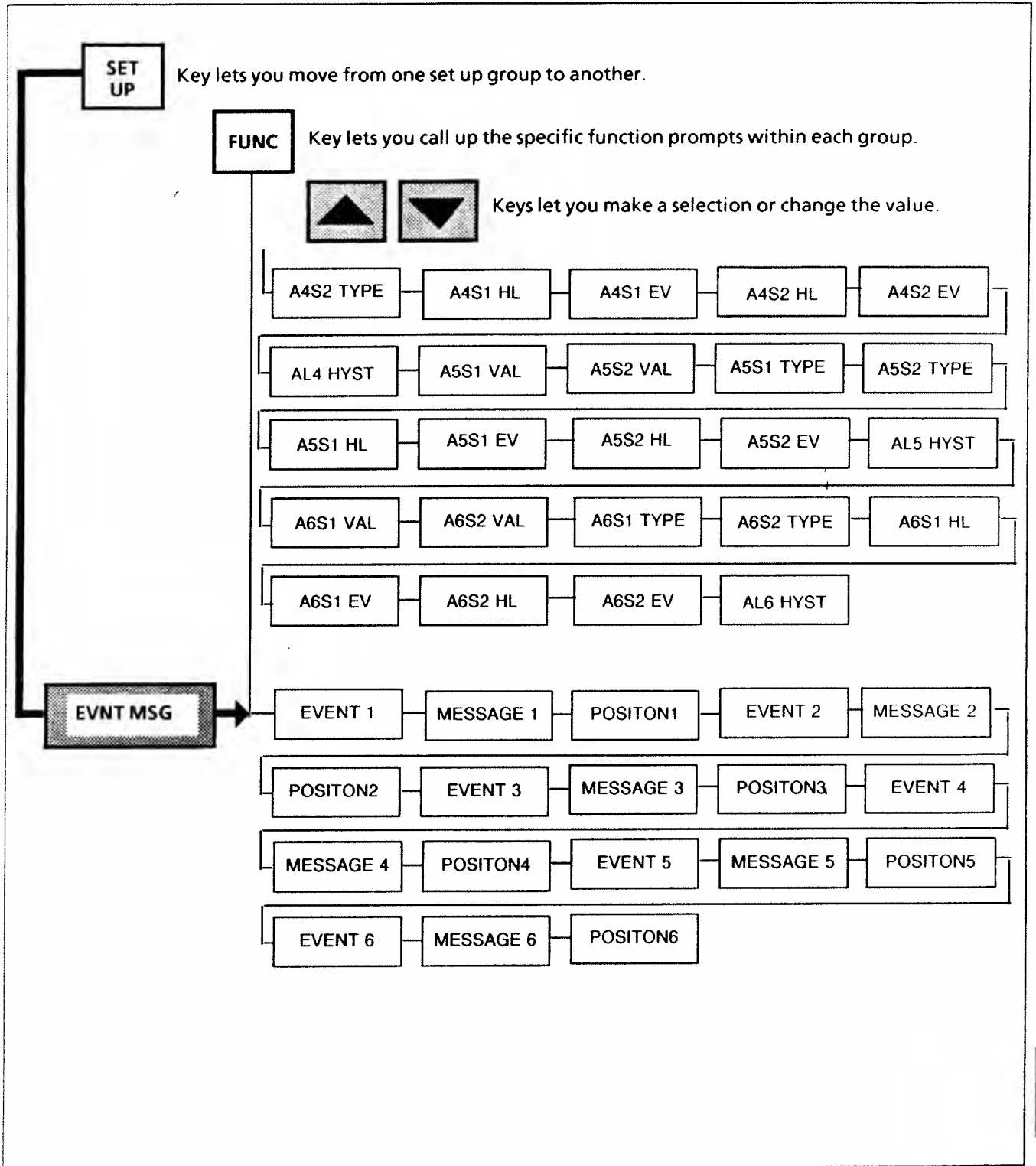

Figure D4-1 -- PROMPT HIERARCHY -- Continued



4. Configuration Changes

D-1. FO RESET Configuration

Prerequisites:

- Table III = 001, 002, or 003, and Table IV = F
- Recorder door is open and power is ON.
- Keypad LOCKOUT configuration is NONE.

1. Press [SET UP] key to put recorder in Configuration (SET UP) Mode and call up FO RESET prompt in lower display. If recorder is in SET UP Mode, successively press [SET UP] key to step through group prompts or hold key in to scroll prompts until FO RESET appears in display.

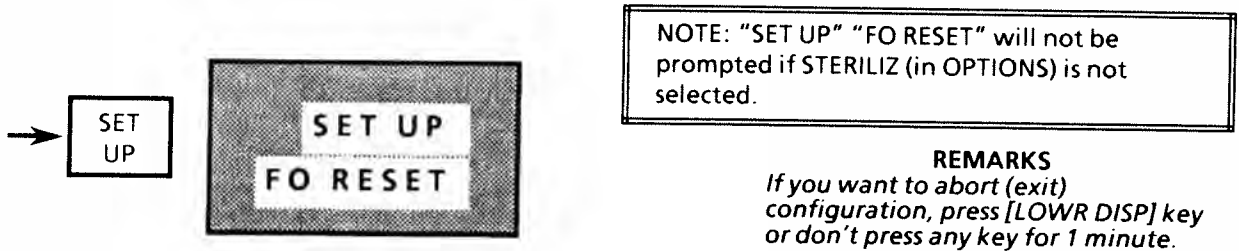

2. Press [FUNC] key to call up parameter for configuration.

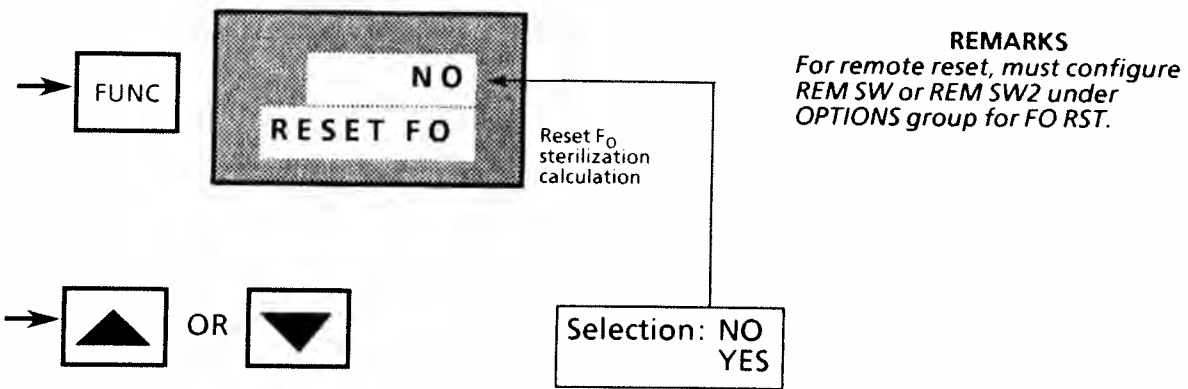

3. Use [RAISE] or [LOWER] key to reset the F_0 sterilization calculation, or go to Step 4.
4. Press [SET UP] key to call up next group prompt and go to appropriate procedure in this section. Or, press [LOWR DISP] key to exit configuration mode.

D-2. OPTIONS Configuration -- Continued from Step 19 on page 4-74

20. Press [FUNC] key to call up next parameter and enter present selection.

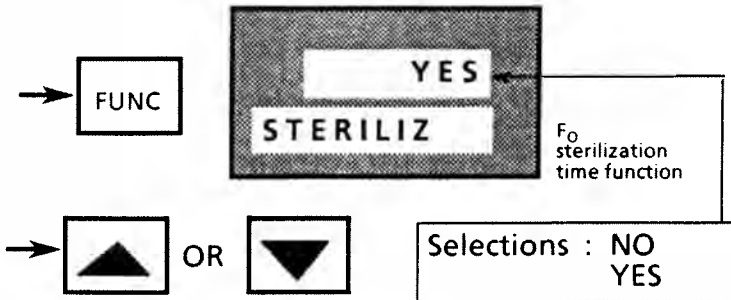

REMARKS
 Only applicable if Table II is 40, Table III is 003 and Table IV is F.
 Sterilization time function computes equivalent sterilization time by accumulating lethality rates for a product over each 1/3 or 2/3 second scan interval of recorder using this equation:

$$T_s = T_{s(t-1)} + dt \times 10^{\frac{(t-T_b)}{z}}$$

Where:

T_s = Sterilization time in minutes.

$T_{s(t-1)}$ = Previous sterilization time.

dt = Time interval (1/3 or 2/3 second)

NOTE: 1/3 second if less than 3 configured inputs; 2/3 second if greater than 2 configured inputs.

T_b = Standard reference temperature (configurable).

t = Product (input) temperature (°F or °C).

z = Thermal resistance (configurable).

21. Use [RAISE] or [LOWER] key to activate (YES) or deactivate (NO) F_0 sterilization calculation.

- If you select YES, go to Step 22; otherwise, go to Step 28.

22. Press [FUNC] key to call up next parameter and enter present selection.

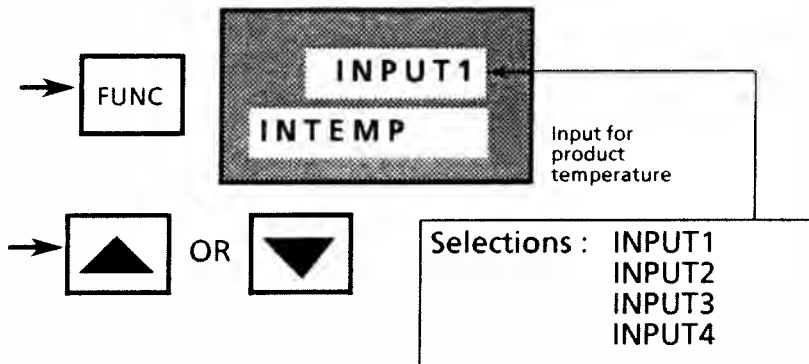

23. Use [RAISE] or [LOWER] key to select which input will supply product temperature for sterilization calculation, or go to Step 24.

D-2. OPTIONS Configuration -- Continued

24. Press [FUNC] key to call up next parameter and enter present selection.

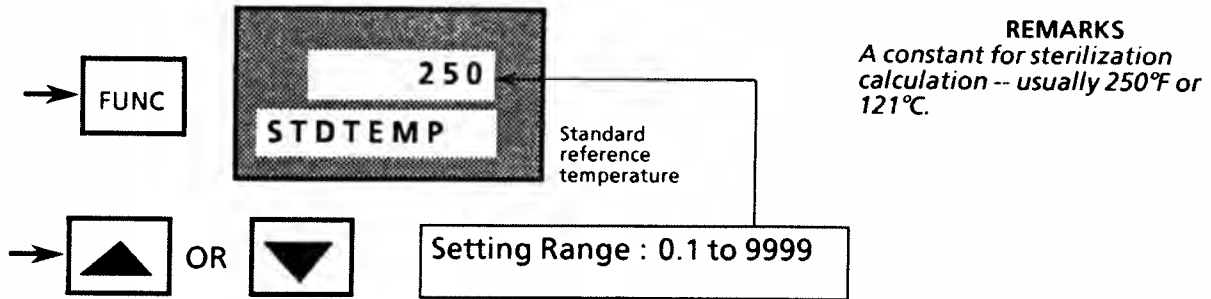

25. Use [RAISE] or [LOWER] key to set desired reference temperature for sterilization calculation, or go to Step 26.

26. Press [FUNC] key to call up next parameter and enter present selection.

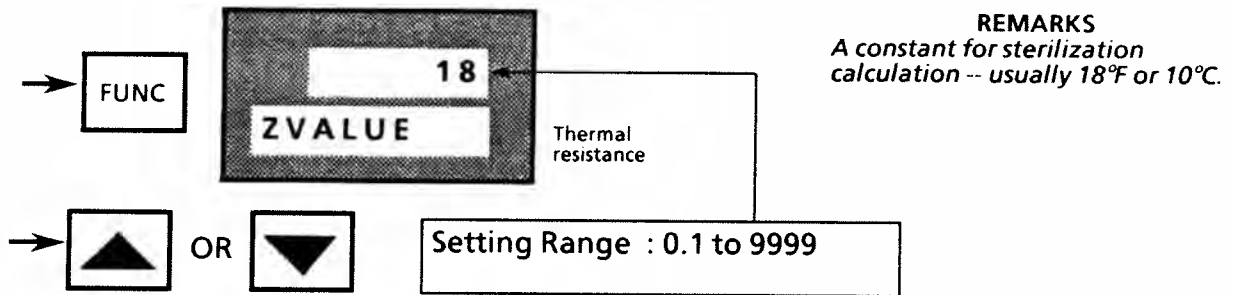

27. Use [RAISE] or [LOWER] key to set desired thermal resistance for sterilization calculation, or: Go to Step 20 on page 4-75 for deviation set point prompts. Go to Step 28 on next page.

D-2. OPTIONS Configuration -- Continued

28. Press [FUNC] key until REM SW parameter appears for configuration.

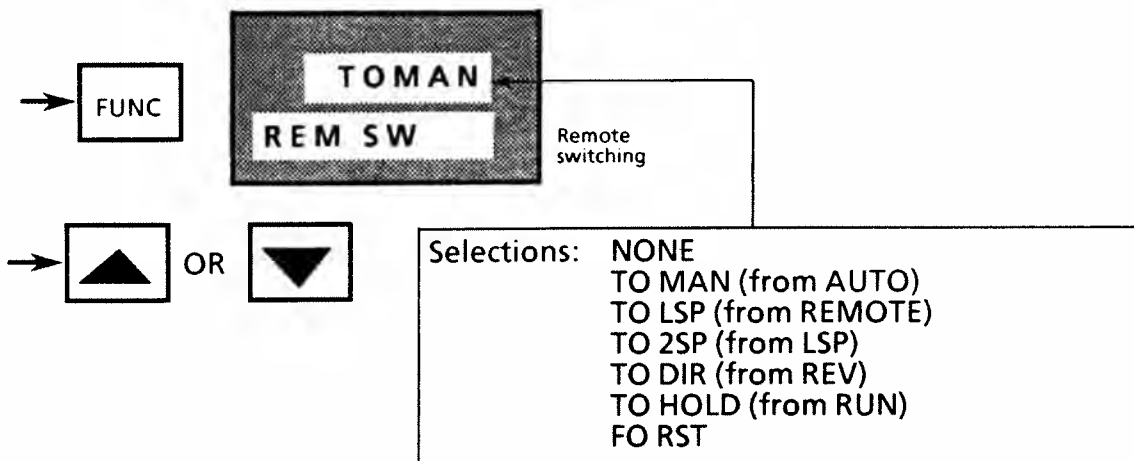

29. Use [RAISE] or [LOWER] key to select action to be initiated by remote contact closure through digital input -- switch controller to manual mode, to local set point, to 2nd set point, to direct output action, put ramp/soak program in HOLD, or reset sterilization calculation, as applicable; or go to Step 30.

30. Press [FUNC] key to call up next parameter and enter present selection.

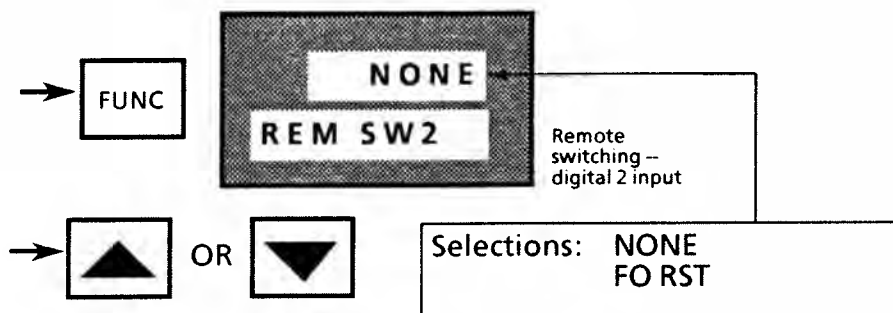

31. Use [RAISE] or [LOWER] key to select remote contact closure through digital 2 input to reset sterilization calculation or not; or go to Step 32.

32. Press [SET UP] key to call up next group prompt and go to appropriate procedure in this section. Or, press [LOWR DISP] key to exit Configuration Mode.

D-3. ALARMS Configuration

Prerequisites:

- Table III = 001, 002 or 003
- Recorder door is open and power is ON..
- Keypad LOCKOUT configuration is NONE

1. Press [SET UP] key to put recorder in Configuration (SET UP) Mode and call up ALARMS prompt in lower display. If recorder is in SET UP Mode, successively press [SET UP] key to step through group prompts or hold key in to scroll prompts until ALARMS appears in display.



REMARKS
 If you want to abort (exit) configuration mode, press [LOWR DISP] key or don't press any key for 1 minute.

2. Press [FUNC] key to call up first control parameter for configuration.

NOTE: Hold key in if you want to scroll through all the function prompts associated with this group.

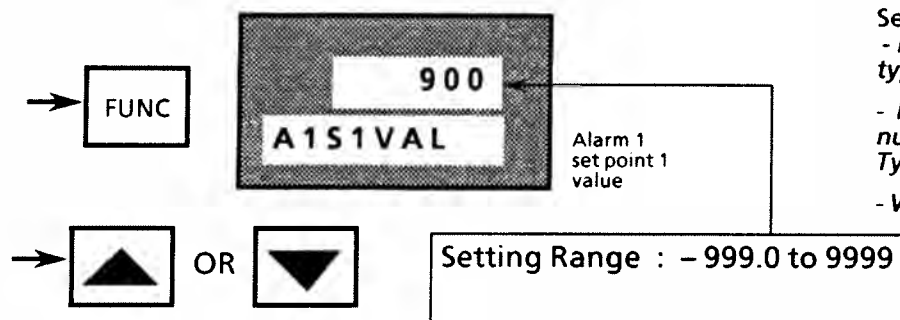

REMARKS
 See Step 6, Alarm Type:
 - Be sure value agrees with alarm type.
 - Note that value equals segment number for EV1 ON or EV1 OFF Type for controller #1 SP program.
 - Will not appear if type is NONE.

3. Use [RAISE] or [LOWER] key to set desired set point 1 value for alarm 1, or go to Step 4.

NOTE: If display blinks, you are trying to select an unacceptable value. You can change value more quickly by holding in one key [RAISE] or [LOWER] and pressing other one [LOWER] or [RAISE] at same time. Adjustment will move one digit to the left with each press.

D-3. ALARMS Configuration -- Continued

NOTE: To recall original value or selection, press [RUN/HOLD] key before pressing [FUNC] key again.

4. Press [FUNC] key to call up next parameter and enter present selection.

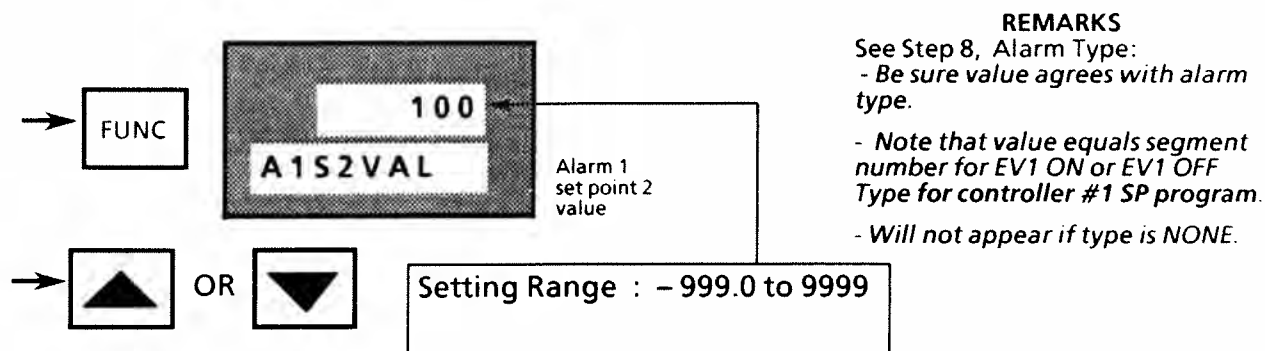

5. Use [RAISE] or [LOWER] key to set desired set point 2 value for alarm 1, or go to Step 6.

6. Press [FUNC] key to call up next parameter and enter present selection.

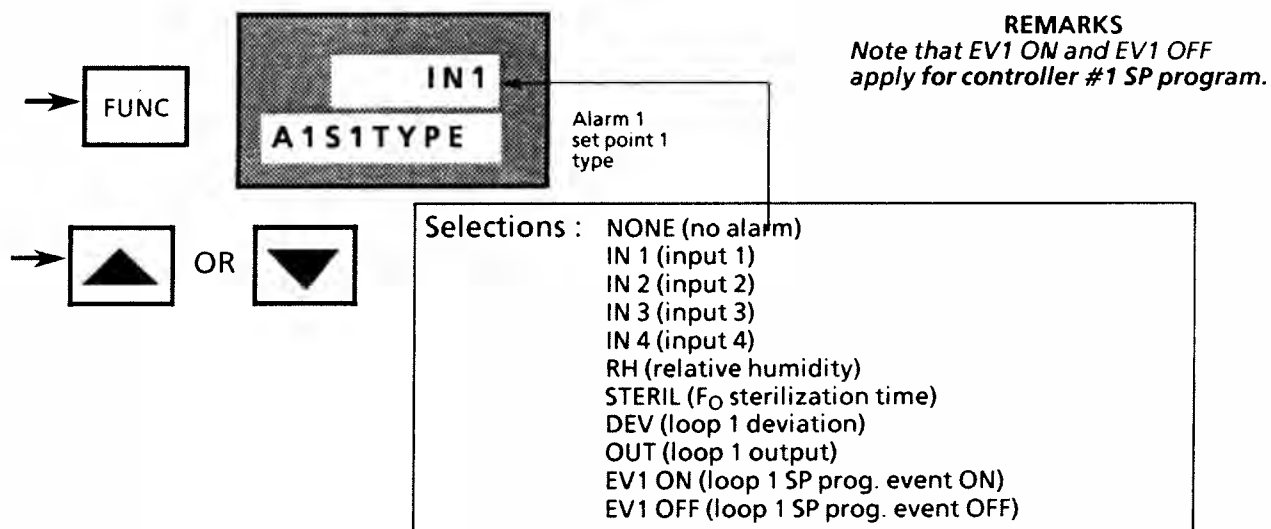

7. Use [RAISE] or [LOWER] key to select desired set point 1 alarm 1 type, or go to Step 8.
 Note that some selections may not appear, depending on your recorder model.

D-3. ALARMS Configuration -- Continued

8. Press [FUNC] key to call up next parameter and enter present selection.

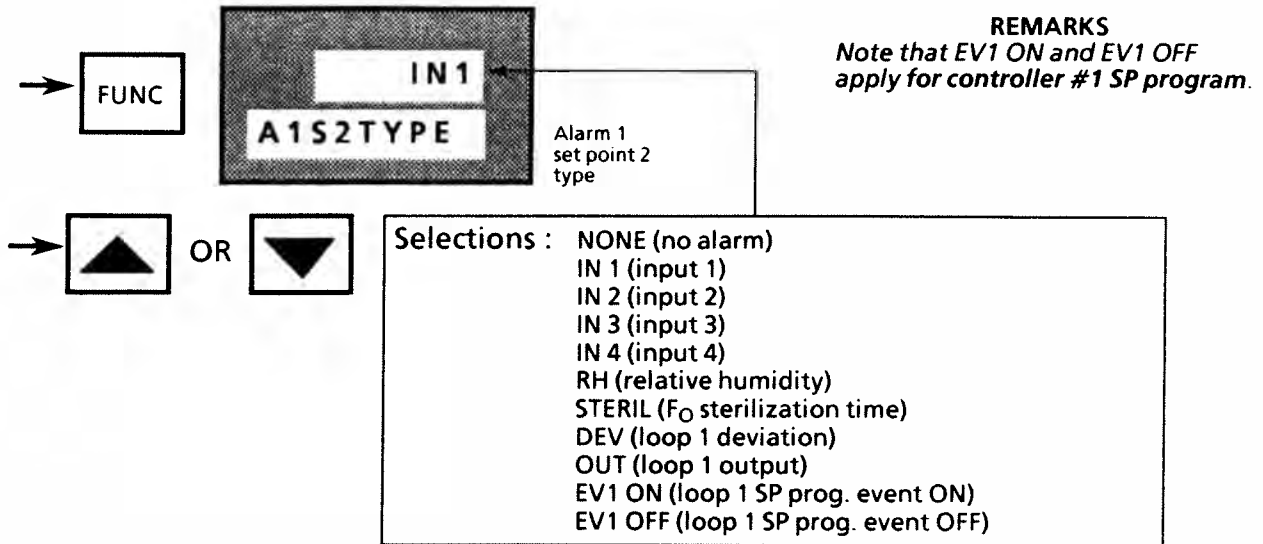

9. Use [RAISE] or [LOWER] key to select desired set point 2 alarm 1 type, or go to Step 10. Note that some selections may not appear, depending on your recorder model.

10. Press [FUNC] key to call up next parameter and enter present selection.

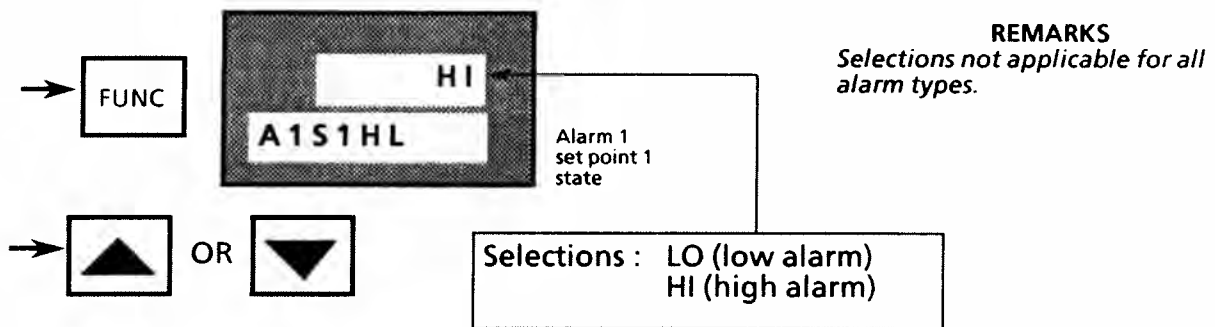

11. Use [RAISE] or [LOWER] key to select applicable set point 1 alarm 1 state, or go to Step 12.

D-3. ALARMS Configuration -- Continued

12. Press [FUNC] key to call up next parameter and enter present selection.

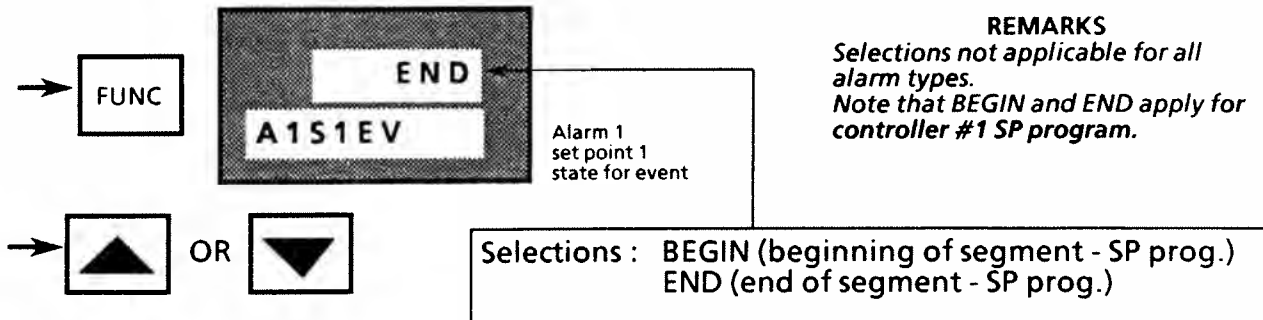

13. Use [RAISE] or [LOWER] key to select applicable set point 1 alarm 1 state for event, or go to Step 14.

14. Press [FUNC] key to call up next parameter and enter present selection.

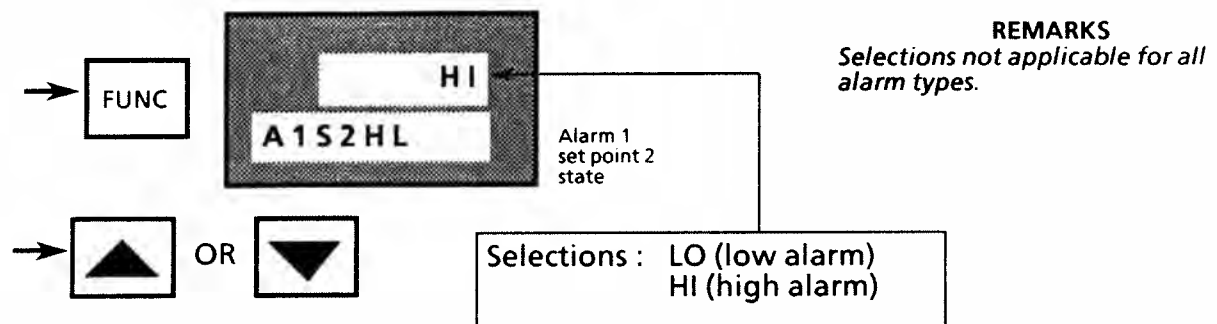

15. Use [RAISE] or [LOWER] key to select applicable set point 2 alarm 1 state, or go to Step 16.

D-3. ALARMS Configuration -- Continued

16. Press [FUNC] key to call up next parameter and enter present selection.

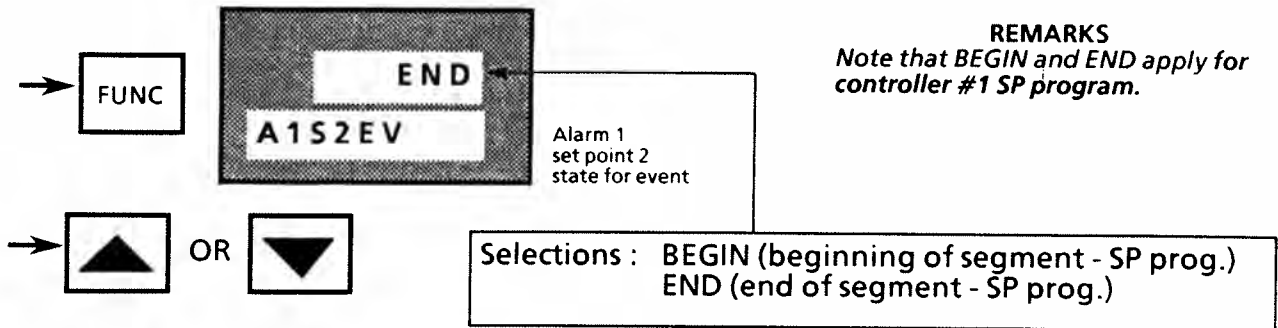

17. Use [RAISE] or [LOWER] key to select applicable set point 2 alarm 1 state for event, or go to Step 18.

18. Press [FUNC] key to call up next parameter and enter present selection.

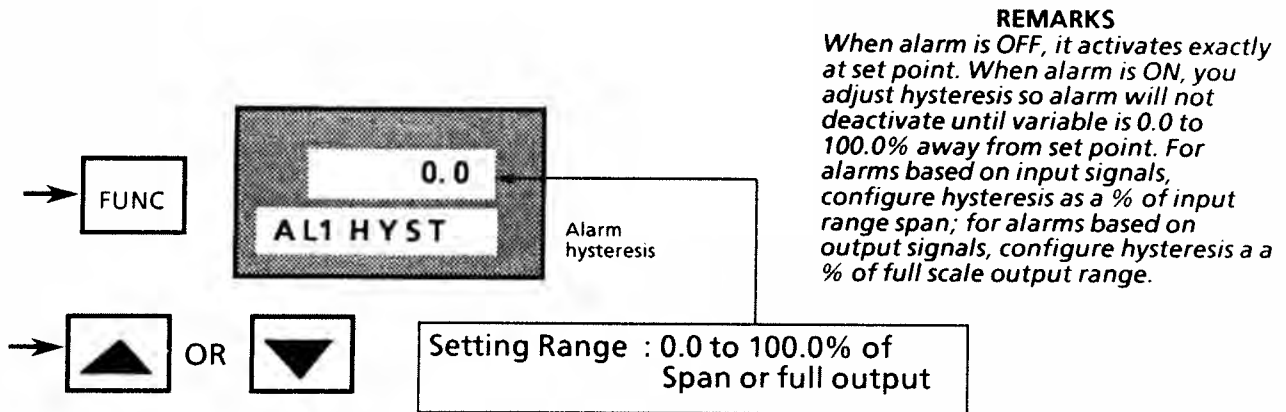

19. Use [RAISE] or [LOWER] key to set hysteresis for alarm action, or go to Step 20.

D-3. ALARMS Configuration -- Continued

20. Press [FUNC] key to call up next parameter and enter present selection.

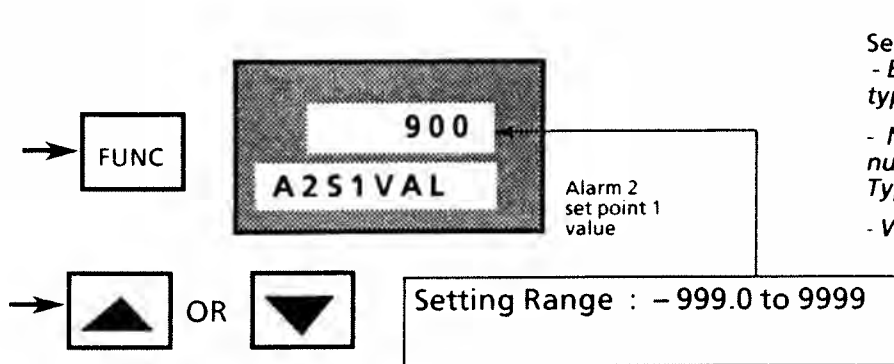

REMARKS
 See Step 24, Alarm Type:
 - Be sure value agrees with alarm type.
 - Note that value equals segment number for EV1 ON or EV1 OFF Type for controller #1 SP program.
 - Will not appear if type is NONE.

21. Use [RAISE] or [LOWER] key to set desired set point 1 for alarm 2, or go to Step 22.

22. Press [FUNC] key to call up next parameter and enter present selection.

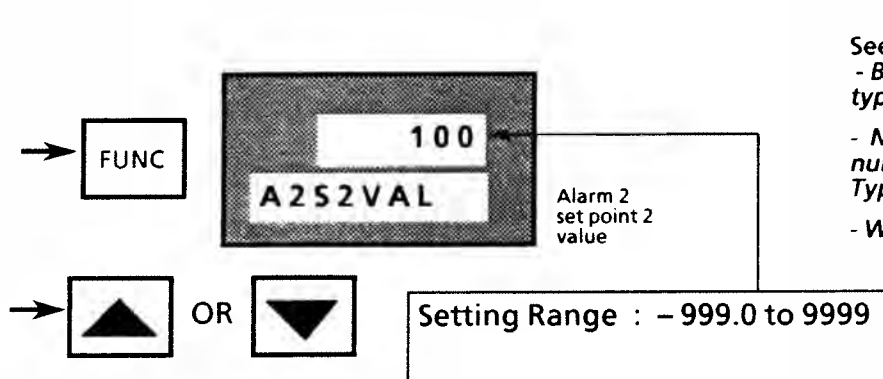

REMARKS
 See Step 26, Alarm Type:
 - Be sure value agrees with alarm type.
 - Note that value equals segment number for EV1 ON or EV1 OFF Type for controller #1 SP program.
 - Will not appear if type is NONE.

23. Use [RAISE] or [LOWER] key to set desired set point 2 value for alarm 2, or go to Step 24.

D-3. ALARMS Configuration -- Continued

24. Press [FUNC] key to call up next parameter and enter present selection.

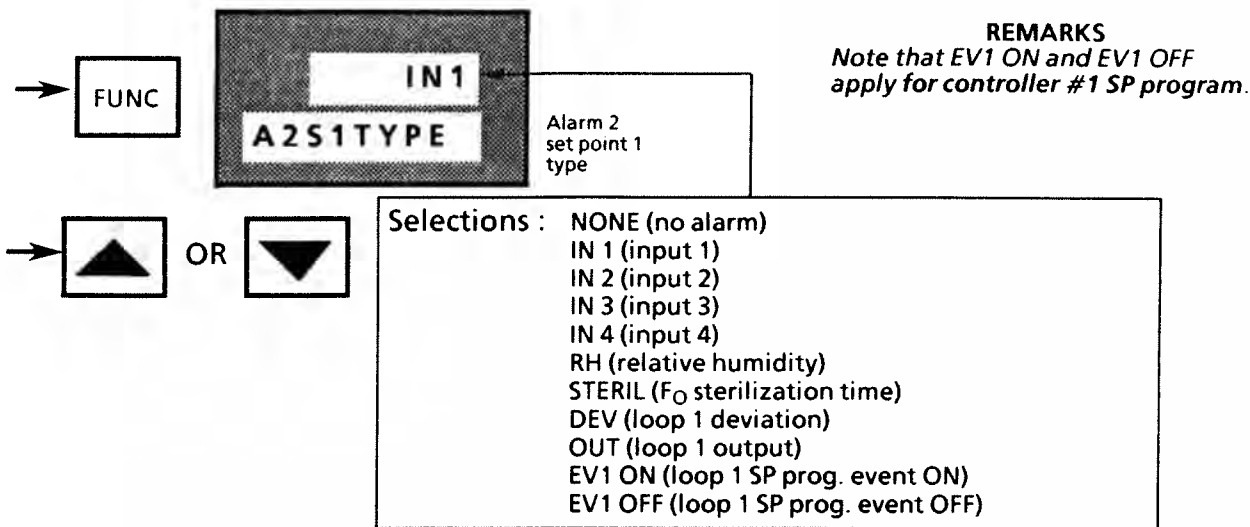

25. Use [RAISE] or [LOWER] key to select desired set point 1 alarm 2 type, or go to Step 26.
 Note that some selections may not appear, depending on your recorder model.

26. Press [FUNC] key to call up next parameter and enter present selection.

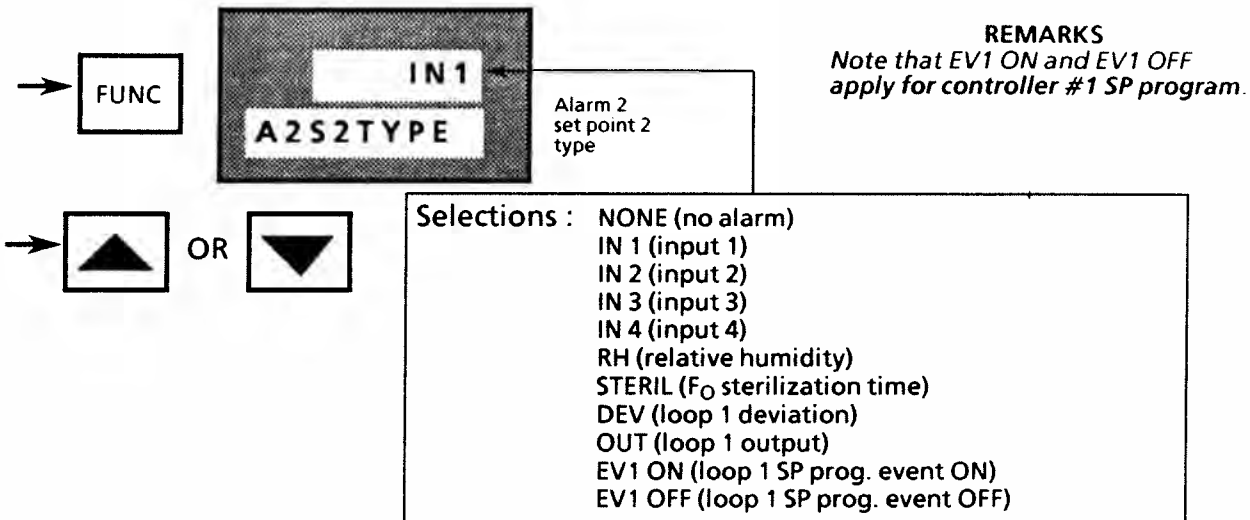

27. Use [RAISE] or [LOWER] key to select desired set point 2 alarm 2 type, or go to Step 28.
 Note that some selections may not appear, depending on your recorder model.

D-3. ALARMS Configuration -- Continued

28. Press [FUNC] key to call up next parameter and enter present selection.

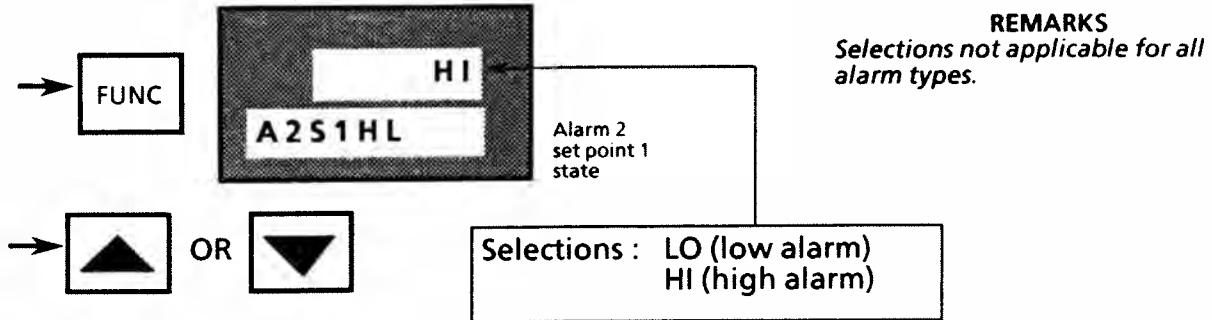

29. Use [RAISE] or [LOWER] key to select applicable set point 1 alarm 2 state, or go to Step 30.

30. Press [FUNC] key to call up next parameter and enter present selection.

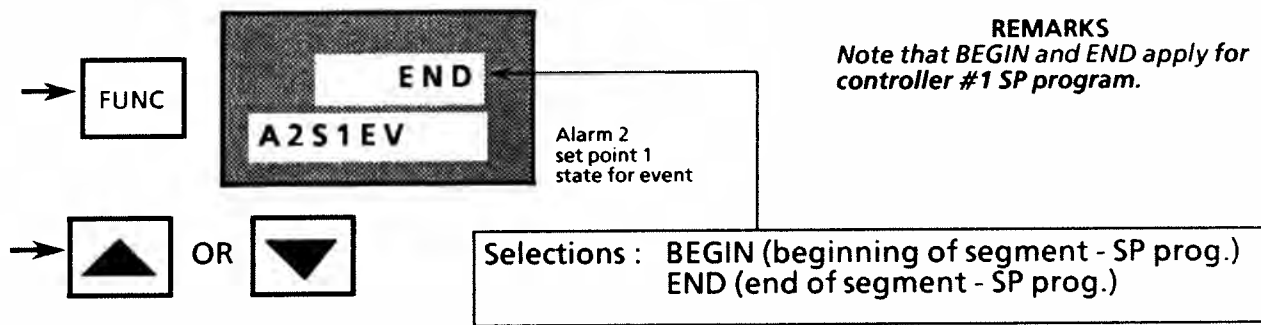

31. Use [RAISE] or [LOWER] key to select applicable set point 1 alarm 2 state for event, or go to Step 32.

D-3. ALARMS Configuration -- Continued

32. Press [FUNC] key to call up next parameter and enter present selection.

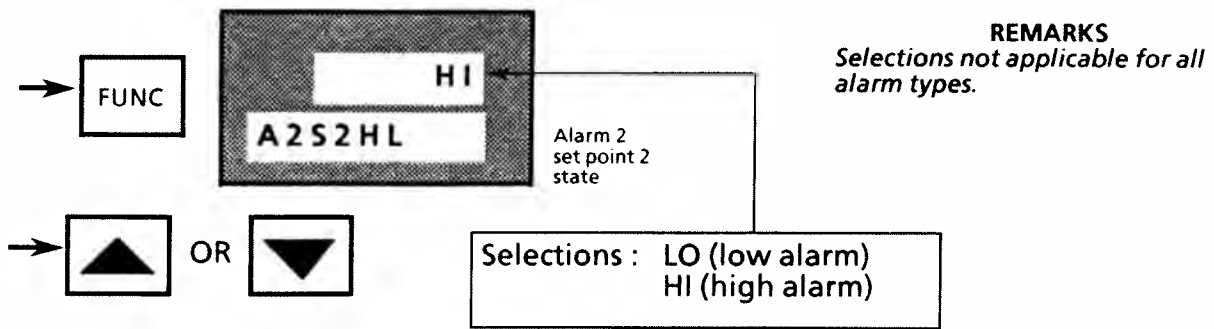

33. Use [RAISE] or [LOWER] key to select applicable set point 2 alarm 2 state, or go to Step 34.

34. Press [FUNC] key to call up next parameter and enter present selection.

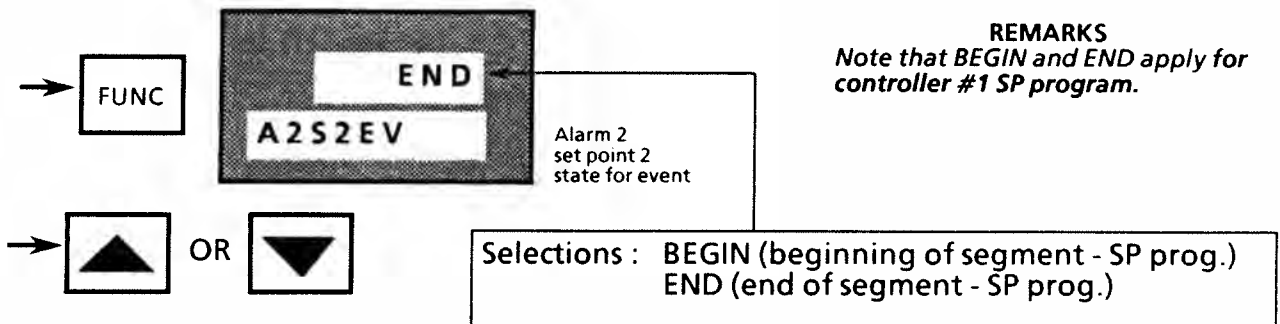

35. Use [RAISE] or [LOWER] key to select applicable set point 2 alarm 2 state for event, or go to Step 36.

D-3. ALARMS Configuration -- Continued

36. Press [FUNC] key to call up next parameter and enter present selection.

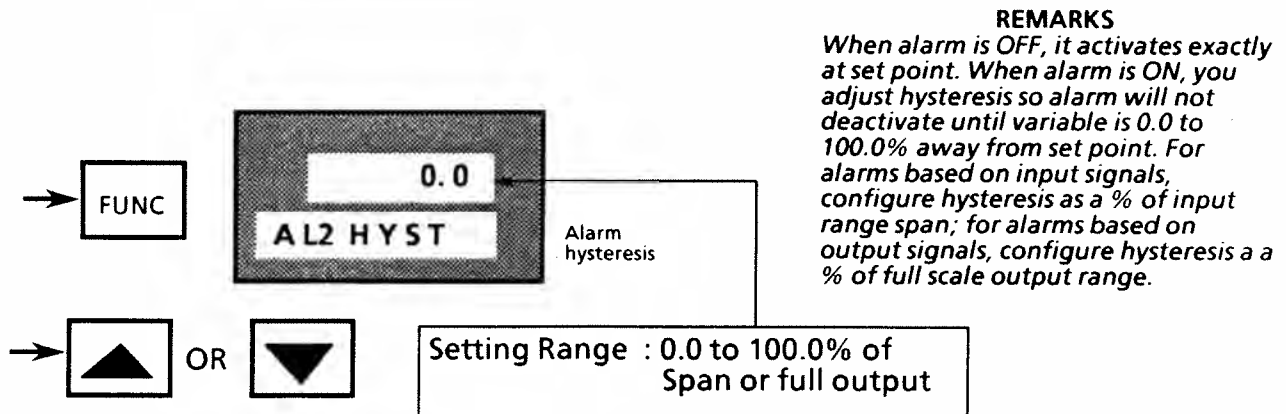

37. Use [RAISE] or [LOWER] key to set hysteresis for alarm action, or go to Step 38.

38. Press [FUNC] key to call up next parameter and enter present selection.

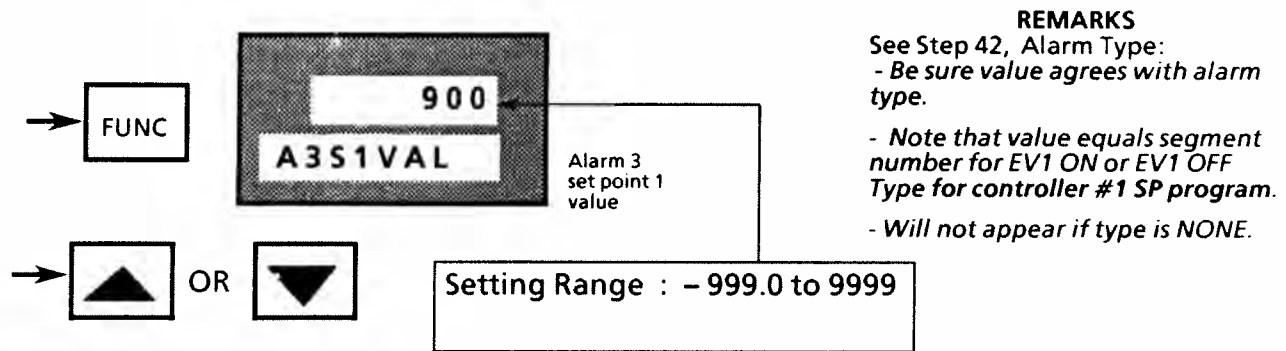

39. Use [RAISE] or [LOWER] key to set desired set point 1 value for alarm 3, or go to Step 40.

D-3. ALARMS Configuration -- Continued

40. Press [FUNC] key to call up next parameter and enter present selection.

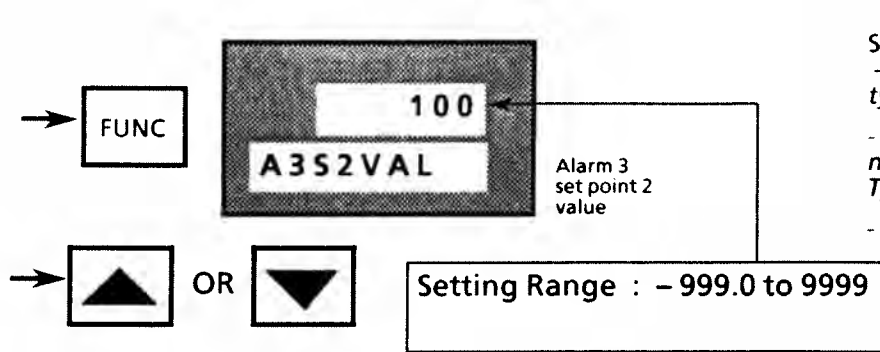

REMARKS
 See Step 44, Alarm Type:
 - Be sure value agrees with alarm type.
 - Note that value equals segment number for EV1 ON or EV1 OFF Type for controller #1 SP program.
 - Will not appear if type is NONE.

41. Use [RAISE] or [LOWER] key to set desired set point 2 value for alarm 3, or go to Step 42.

42. Press [FUNC] key to call up next parameter and enter present selection.

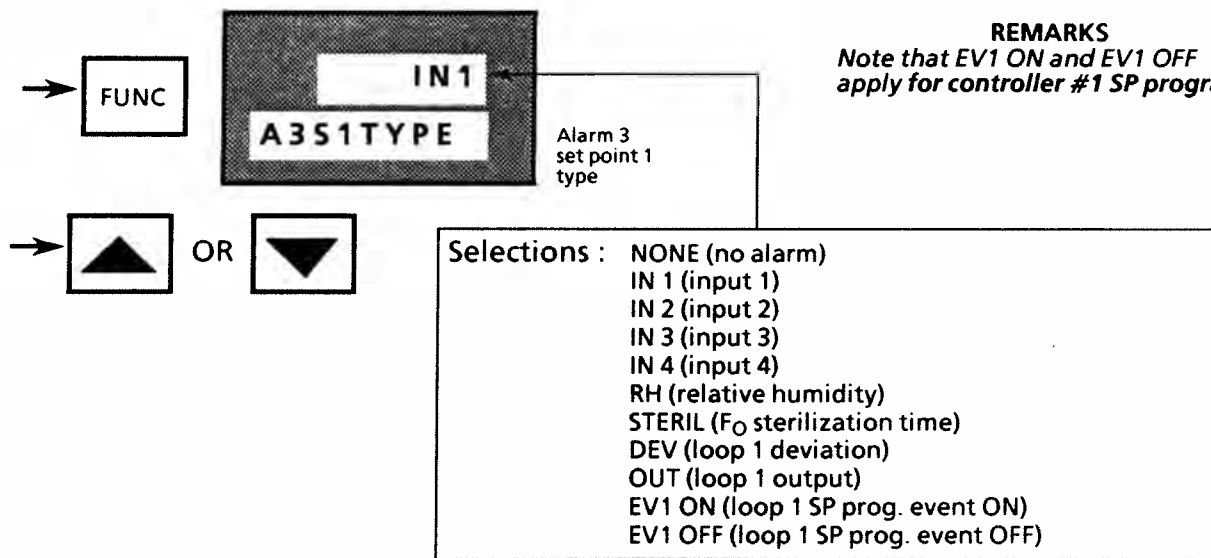

REMARKS
 Note that EV1 ON and EV1 OFF apply for controller #1 SP program.

43. Use [RAISE] or [LOWER] key to select desired set point 1 alarm 3 type, or go to Step 44. Note that some selections may not appear, depending on your recorder model.

D-3. ALARMS Configuration -- Continued

44. Press [FUNC] key to call up next parameter and enter present selection.

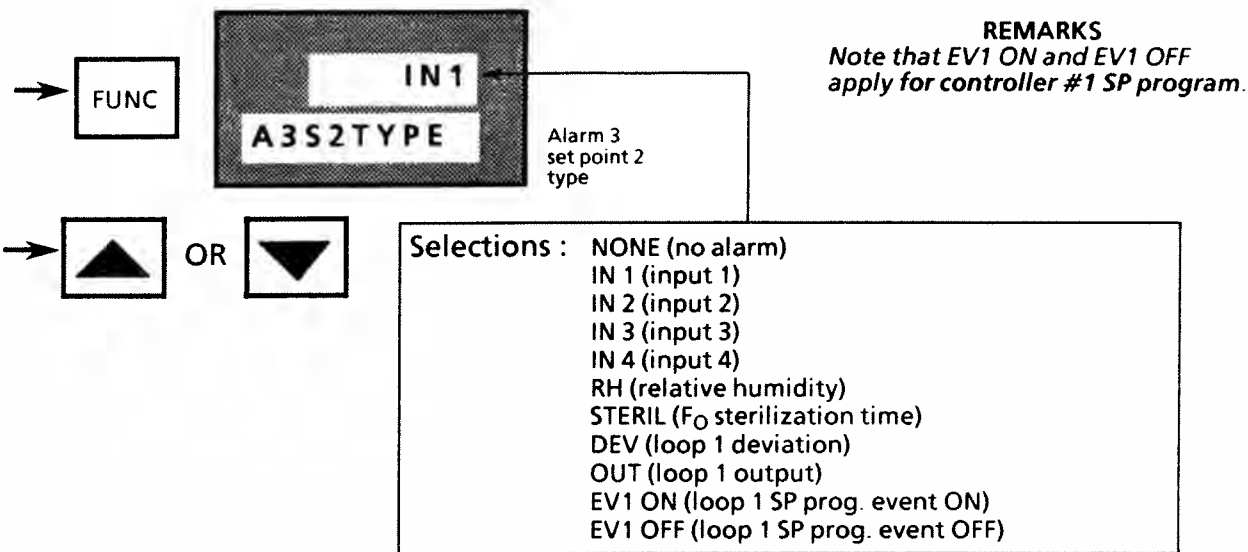

45. Use [RAISE] or [LOWER] key to select desired set point 2 alarm 3 type, or go to Step 46. Note that some selections may not appear, depending on your recorder model.

46. Press [FUNC] key to call up next parameter and enter present selection.

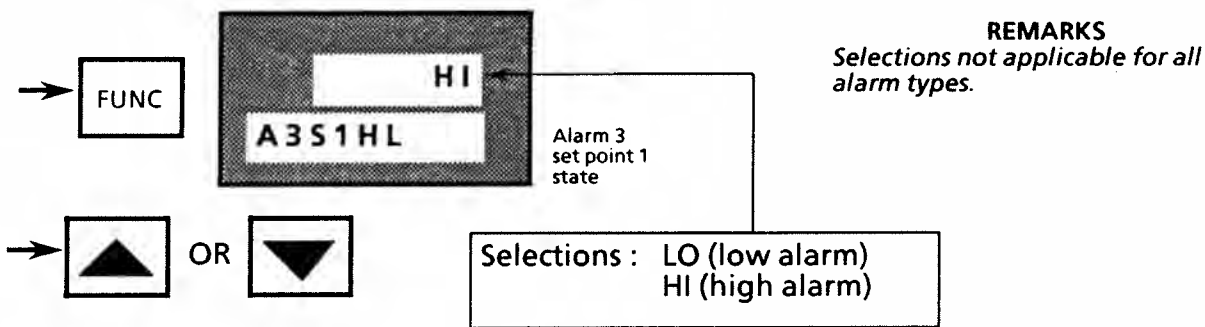

47. Use [RAISE] or [LOWER] key to select applicable set point 1 alarm 3 state, or go to Step 48.

D-3. ALARMS Configuration -- Continued

48. Press [FUNC] key to call up next parameter and enter present selection.

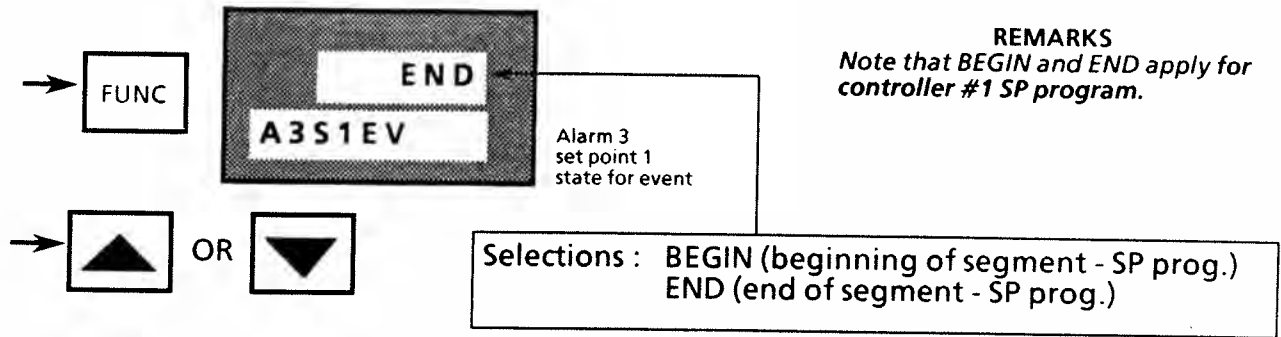

49. Use [RAISE] or [LOWER] key to select applicable set point 1 alarm 3 state for event, or go to Step 50.

50. Press [FUNC] key to call up next parameter and enter present selection.

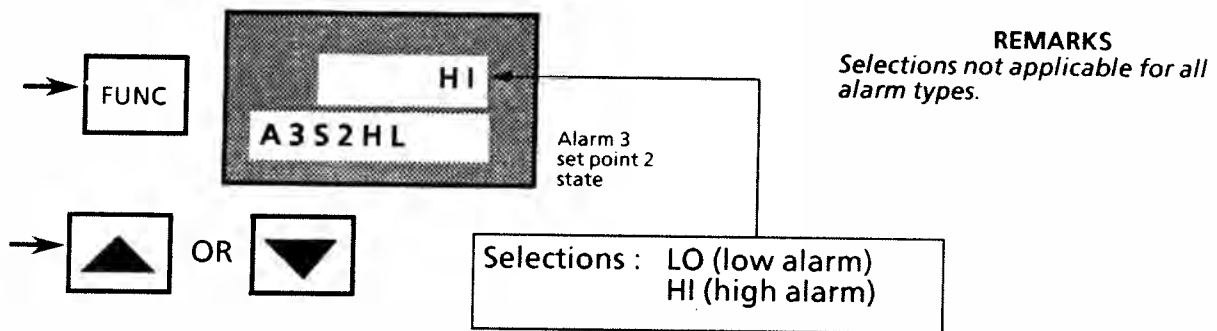

51. Use [RAISE] or [LOWER] key to select applicable set point 2 alarm 3 state, or go to Step 52.

D-3. ALARMS Configuration -- Continued

52. Press [FUNC] key to call up next parameter and enter present selection.

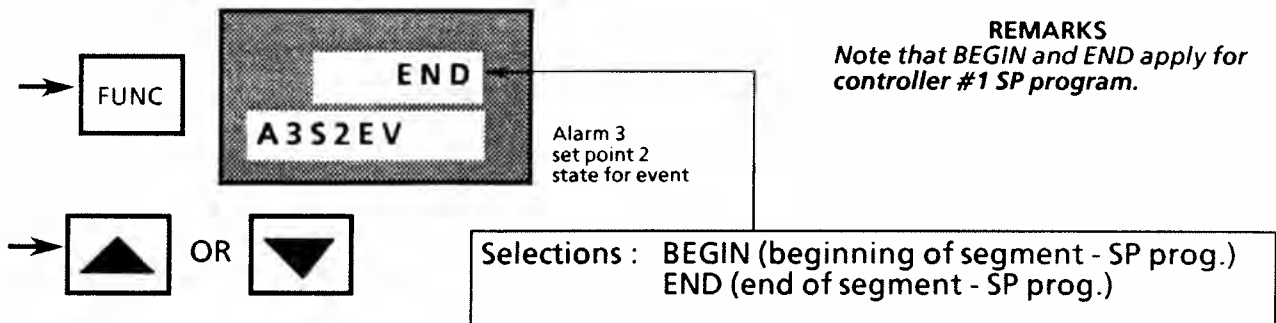

53. Use [RAISE] or [LOWER] key to select applicable set point 2 alarm 3 state for event, or go to Step 54.

54. Press [FUNC] key to call up next parameter and enter present selection.

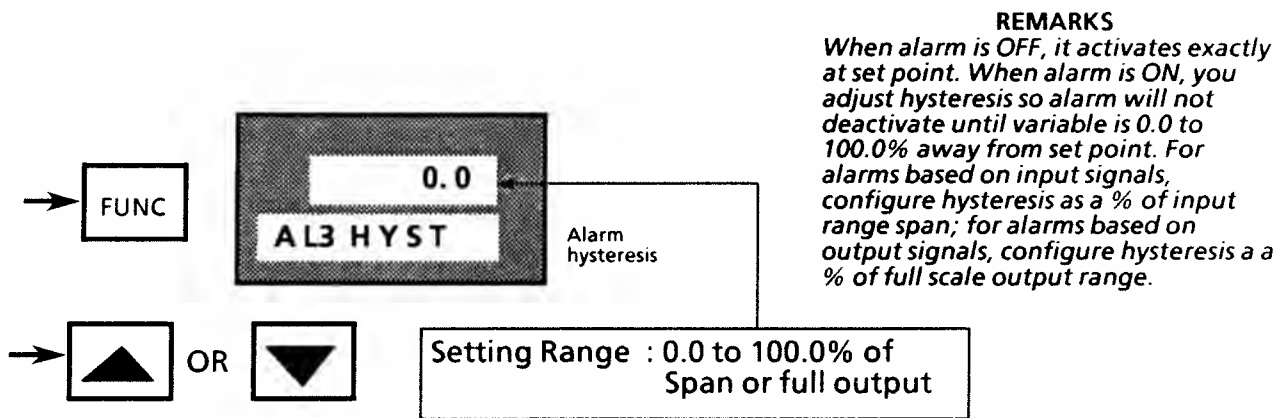

55. Use [RAISE] or [LOWER] key to set hysteresis for alarm action, or go to Step 56.

D-3. ALARMS Configuration -- Continued

56. Press [FUNC] key to call up next parameter and enter present selection.

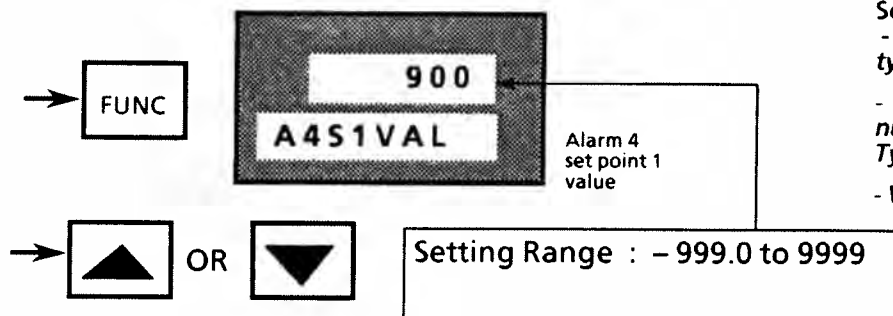

REMARKS
 See Step 60, Alarm Type:
 - Be sure value agrees with alarm type.
 - Note that value equals segment number for EV1 ON or EV1 OFF Type for controller #1 SP program.
 - Will not appear if type is NONE.

57. Use [RAISE] or [LOWER] key to set desired set point 1 value for alarm 4, or go to Step 58.

58. Press [FUNC] key to call up next parameter and enter present selection.

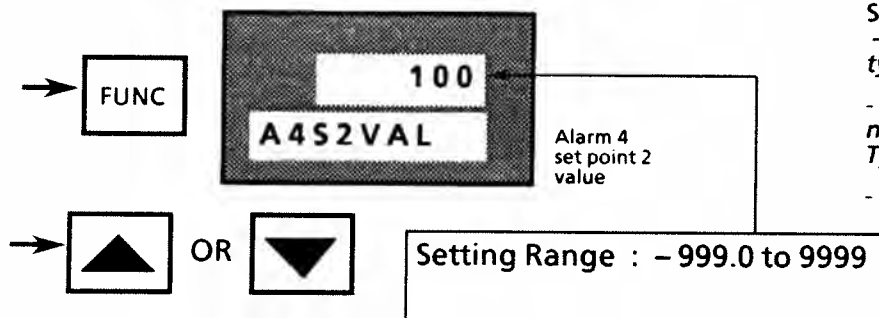

REMARKS
 See Step 62, Alarm Type:
 - Be sure value agrees with alarm type.
 - Note that value equals segment number for EV1 ON or EV1 OFF Type for controller #1 SP program.
 - Will not appear if type is NONE.

59. Use [RAISE] or [LOWER] key to set desired set point 2 value for alarm 4, or go to Step 60.

D-3. ALARMS Configuration -- Continued

60. Press [FUNC] key to call up next parameter and enter present selection.

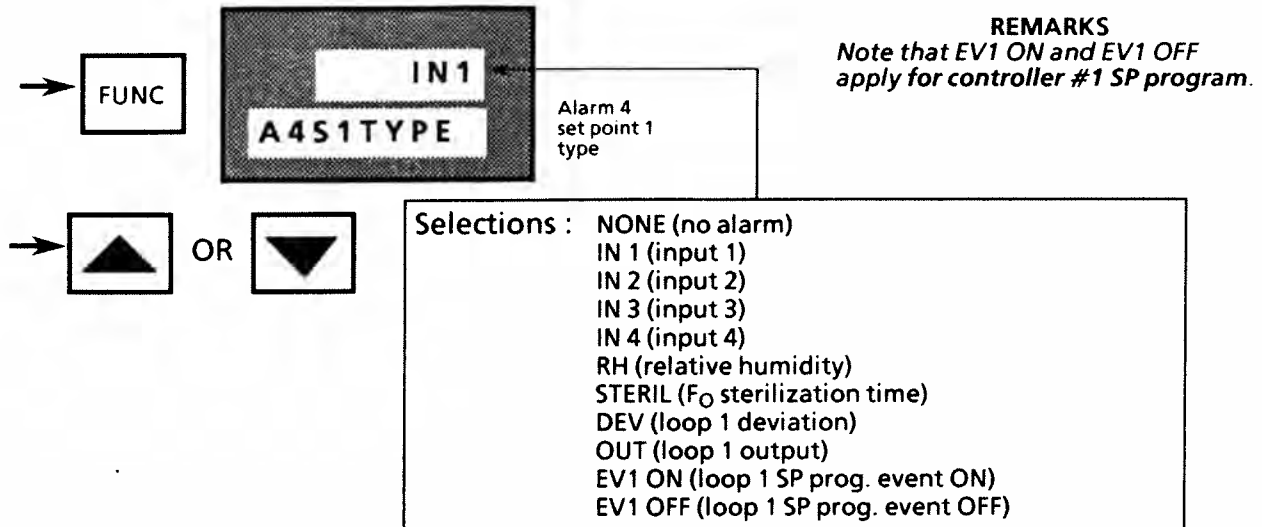

61. Use [RAISE] or [LOWER] key to select desired set point 1 alarm 4 type, or go to Step 62.
 Note that some selections may not appear, depending on your recorder model.

62. Press [FUNC] key to call up next parameter and enter present selection.

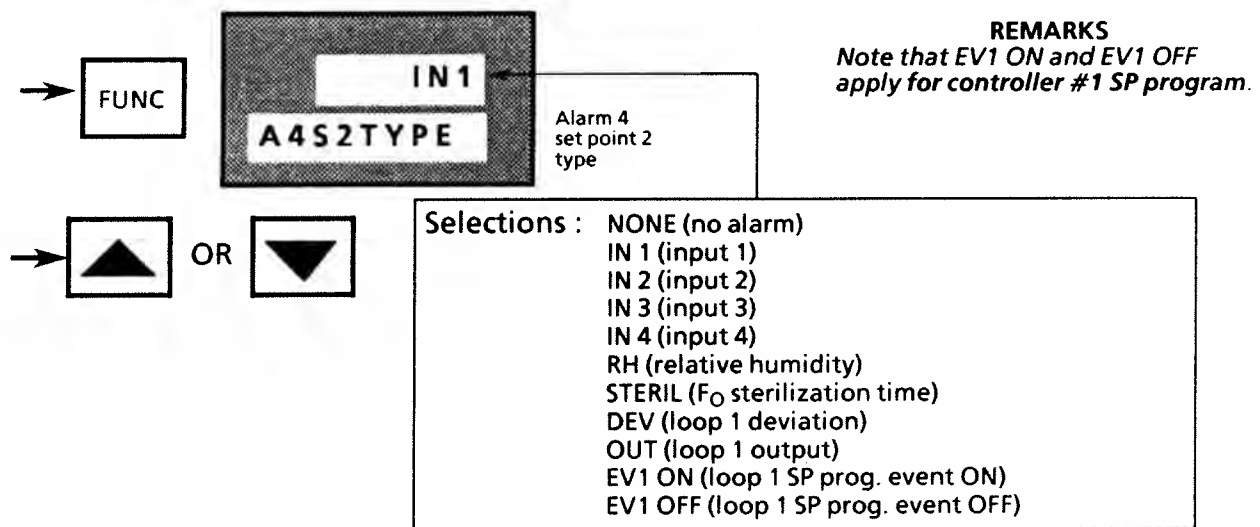

63. Use [RAISE] or [LOWER] key to select desired set point 2 alarm 4 type, or go to Step 64.
 Note that some selections may not appear, depending on your recorder model.

D-3. ALARMS Configuration -- Continued

64. Press [FUNC] key to call up next parameter and enter present selection.

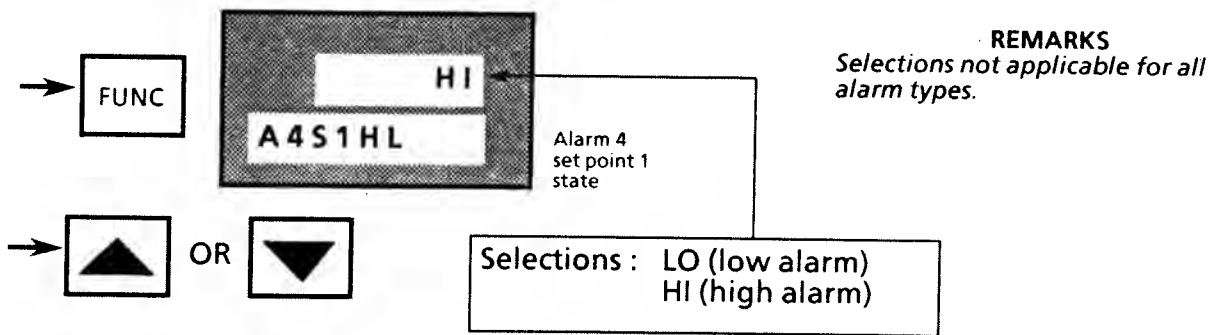

65. Use [RAISE] or [LOWER] key to select applicable set point 1 alarm 4 state, or go to Step 66.

66. Press [FUNC] key to call up next parameter and enter present selection.

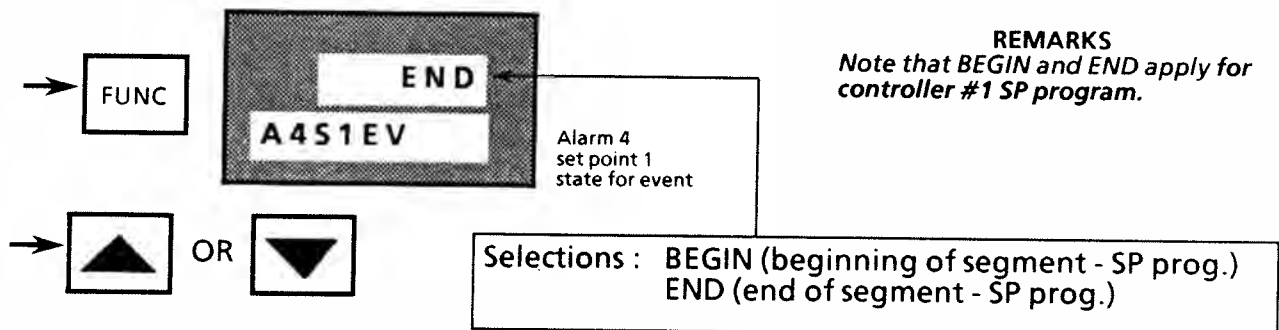

67. Use [RAISE] or [LOWER] key to select applicable set point 1 alarm 4 state for event, or go to Step 68.

D-3. ALARMS Configuration -- Continued

68. Press [FUNC] key to call up next parameter and enter present selection.

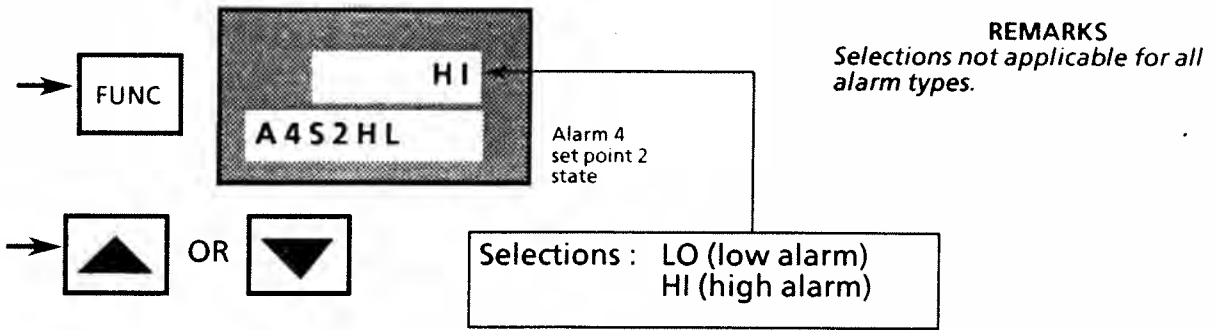

69. Use [RAISE] or [LOWER] key to select applicable set point 2 alarm 4 state, or go to Step 70.

70. Press [FUNC] key to call up next parameter and enter present selection.

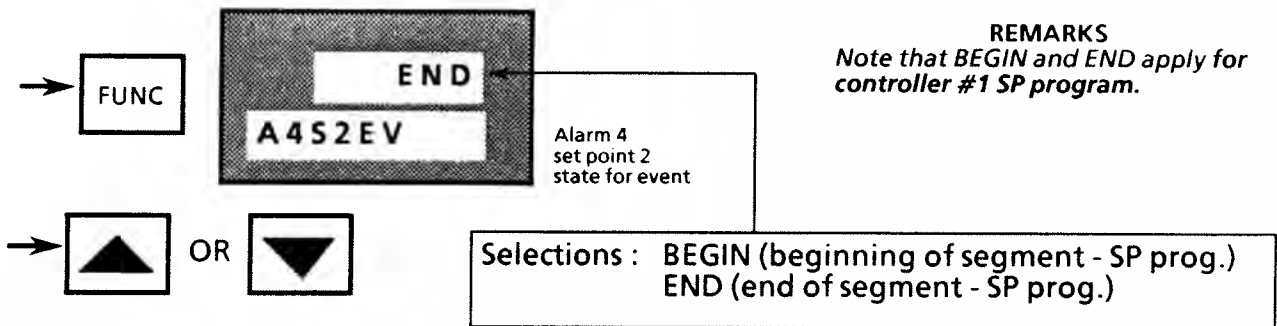

71. Use [RAISE] or [LOWER] key to select applicable set point 2 alarm 4 state for event, or go to Step 72.

D-3. OPTIONS Configuration -- Continued

72. Press [FUNC] key to call up next parameter and enter present selection.

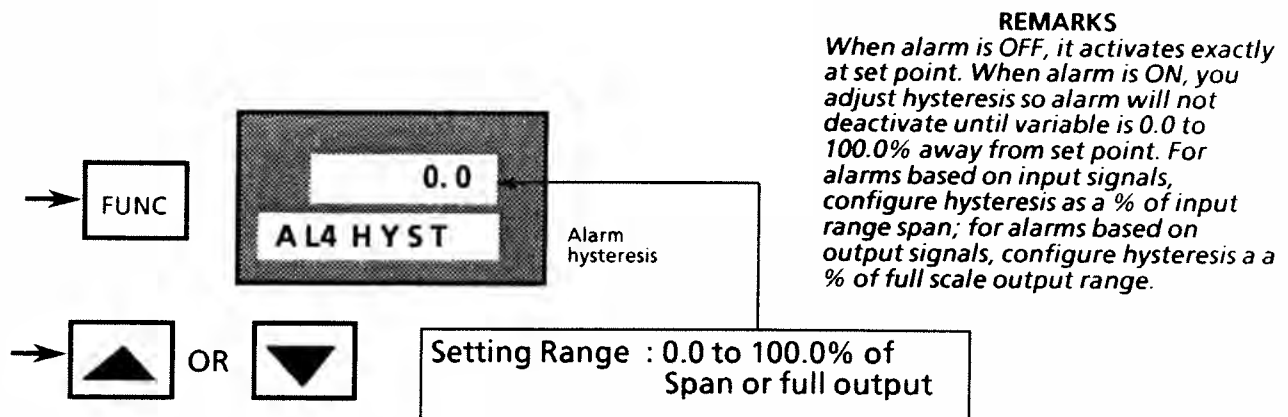

73. Use [RAISE] or [LOWER] key to set hysteresis for alarm action, or go to Step 74.

74. Press [FUNC] key to call up next parameter and enter present selection.

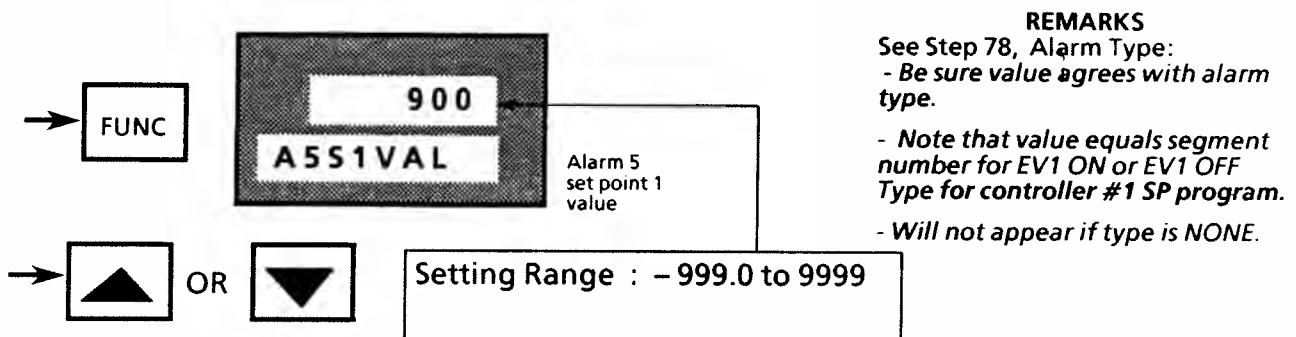

75. Use [RAISE] or [LOWER] key to set desired set point 1 value for alarm 5, or go to Step 76.

D-3. ALARMS Configuration -- Continued

76. Press [FUNC] key to call up next parameter and enter present selection.

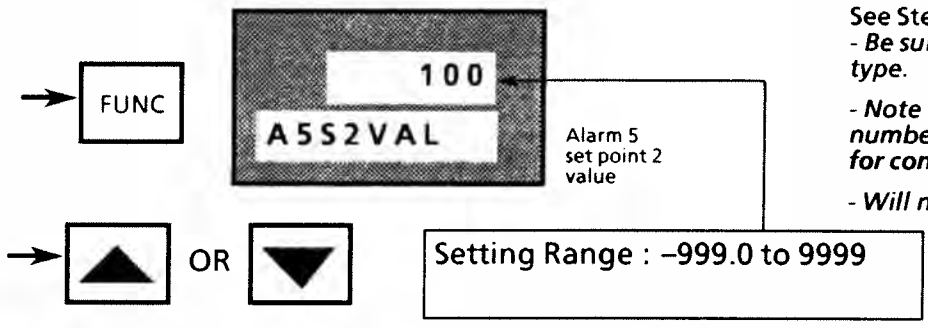

REMARKS
 See Step 80, Alarm Type:
 - Be sure value agrees with alarm type.
 - Note that value equals segment number for EV1 ON or EV1 OFF Type for controller #1 SP program.
 - Will not appear if type is NONE.

77. Use [RAISE] or [LOWER] key to set desired set point 2 value for alarm 5, or go to Step 78.

78. Press [FUNC] key to call up next parameter and enter present selection.

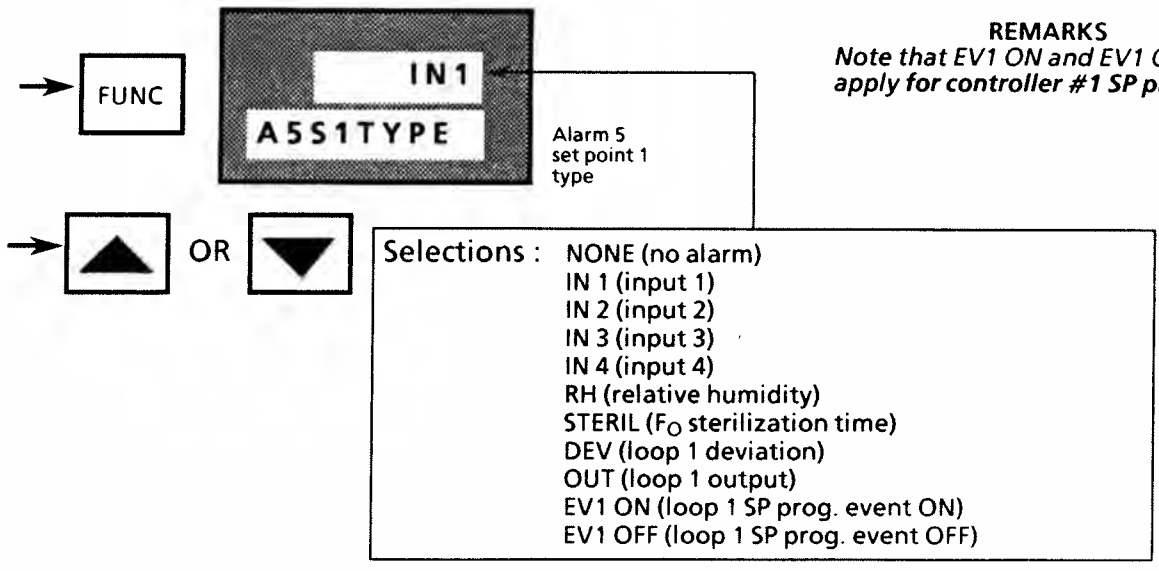

REMARKS
 Note that EV1 ON and EV1 OFF apply for controller #1 SP program.

- Selections :
- NONE (no alarm)
 - IN 1 (input 1)
 - IN 2 (input 2)
 - IN 3 (input 3)
 - IN 4 (input 4)
 - RH (relative humidity)
 - STERIL (F₀ sterilization time)
 - DEV (loop 1 deviation)
 - OUT (loop 1 output)
 - EV1 ON (loop 1 SP prog. event ON)
 - EV1 OFF (loop 1 SP prog. event OFF)

79. Use [RAISE] or [LOWER] key to select desired set point 1 alarm 5 type, or go to Step 80. Note that some selections may not appear, depending on your recorder model.

D-3. ALARMS Configuration -- Continued

80. Press [FUNC] key to call up next parameter and enter present selection.

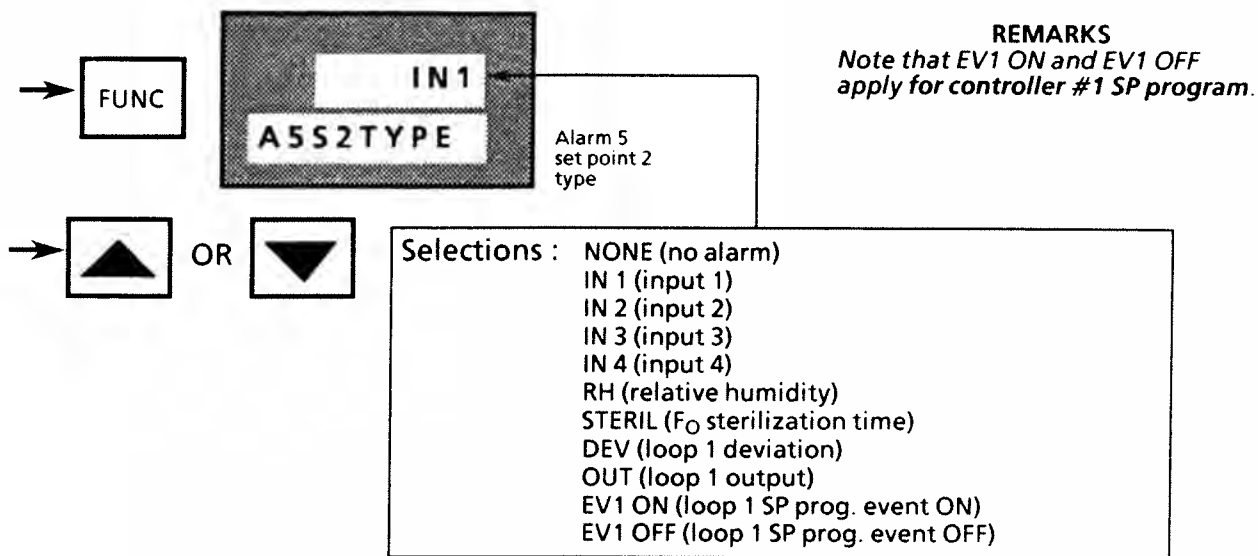

81. Use [RAISE] or [LOWER] key to select desired set point 2 alarm 5 type, or go to Step 82. Note that some selections may not appear, depending on your recorder model.

82. Press [FUNC] key to call up next parameter and enter present selection.

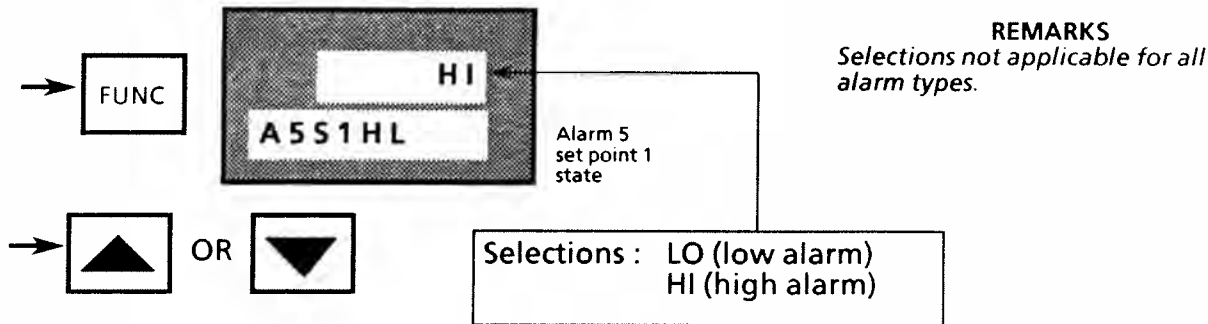

83. Use [RAISE] or [LOWER] key to select applicable set point 1 alarm 5 state, or go to Step 84.

D-3. ALARMS Configuration -- Continued

84. Press [FUNC] key to call up next parameter and enter present selection.

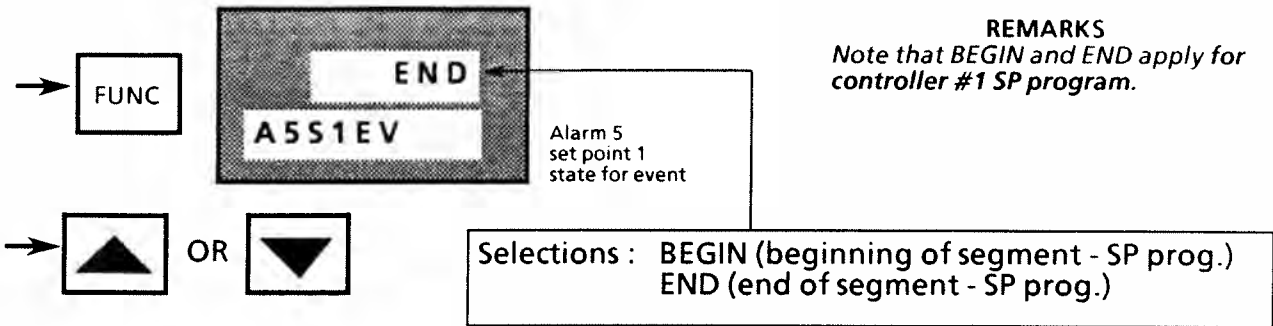

85. Use [RAISE] or [LOWER] key to select applicable set point 1 alarm 5 state for event, or go to Step 86.

86. Press [FUNC] key to call up next parameter and enter present selection.

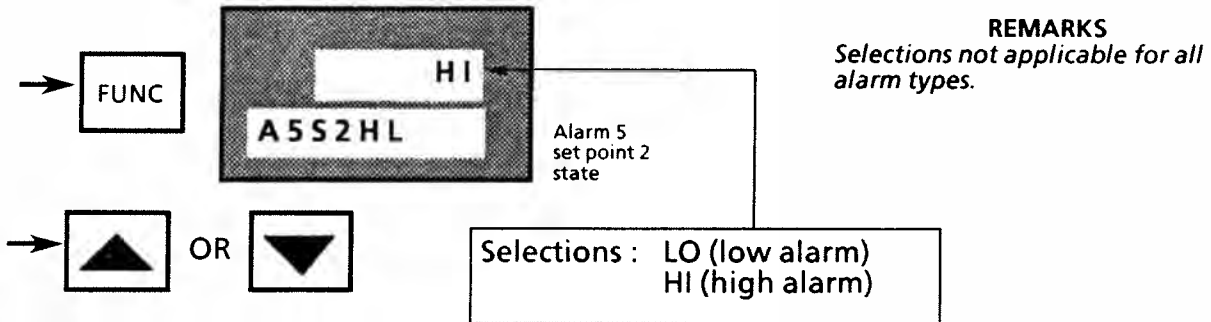

87. Use [RAISE] or [LOWER] key to select applicable set point 2 alarm 5 state, or go to Step 88.

D-3. ALARMS Configuration -- Continued

88. Press [FUNC] key to call up next parameter and enter present selection.

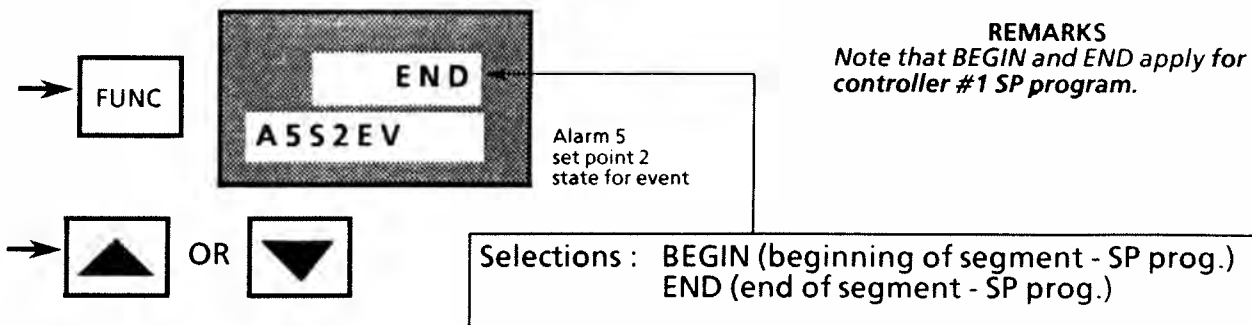

89. Use [RAISE] or [LOWER] key to select applicable set point 2 alarm 5 state for event, or go to Step 90.

90. Press [FUNC] key to call up next parameter and enter present selection.

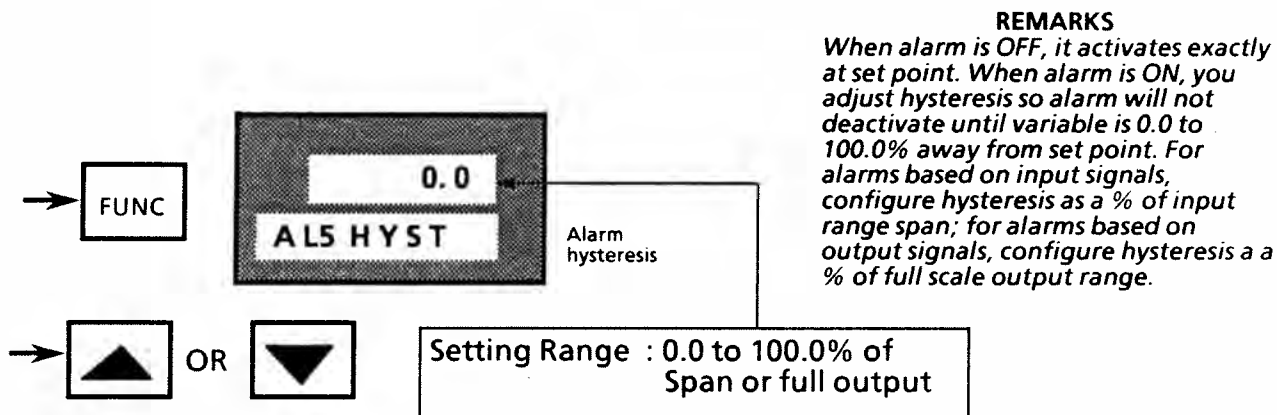

91. Use [RAISE] or [LOWER] key to set hysteresis for alarm action, or go to Step 92.

D-3. ALARMS Configuration -- Continued

92. Press [FUNC] key to call up next parameter and enter present selection.

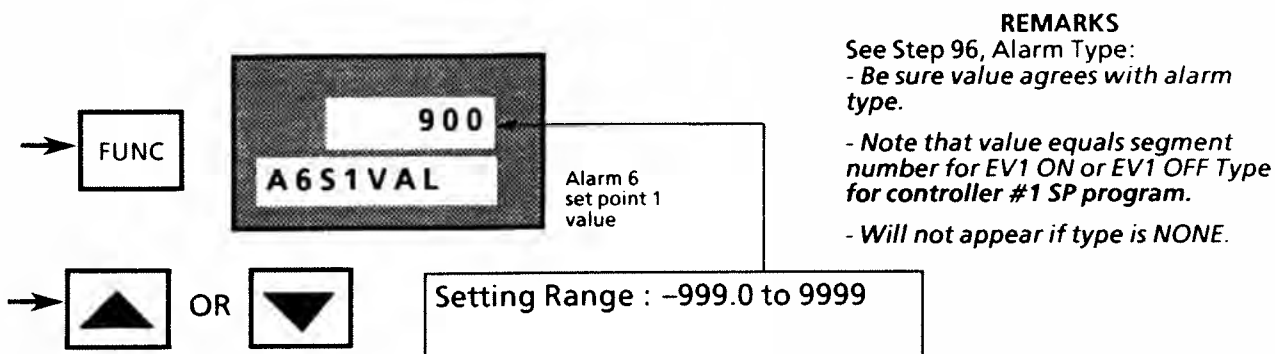

REMARKS
 See Step 96, Alarm Type:
 - Be sure value agrees with alarm type.
 - Note that value equals segment number for EV1 ON or EV1 OFF Type for controller #1 SP program.
 - Will not appear if type is NONE.

93. Use [RAISE] or [LOWER] key to set desired set point 1 value for alarm 6, or go to Step 94.

94. Press [FUNC] key to call up next parameter and enter present selection.

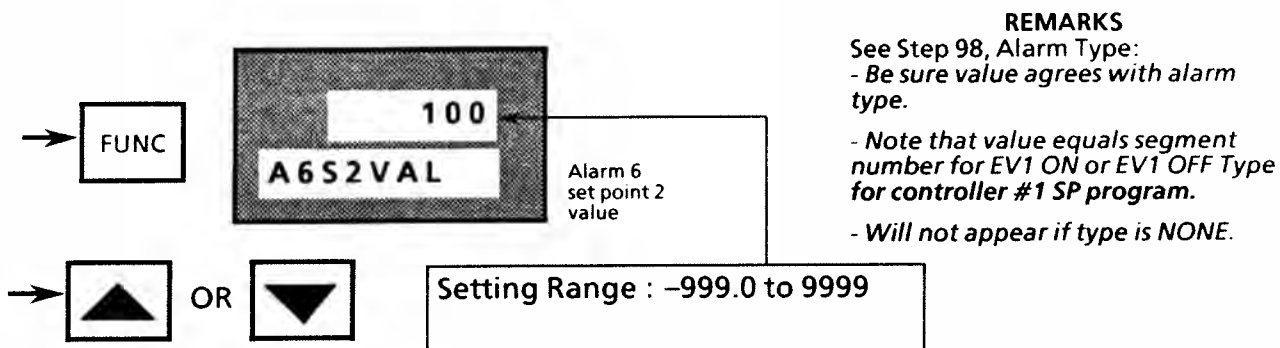

REMARKS
 See Step 98, Alarm Type:
 - Be sure value agrees with alarm type.
 - Note that value equals segment number for EV1 ON or EV1 OFF Type for controller #1 SP program.
 - Will not appear if type is NONE.

95. Use [RAISE] or [LOWER] key to set desired set point 2 value for alarm 6, or go to Step 96.

D-3. ALARMS Configuration -- Continued

96. Press [FUNC] key to call up next parameter and enter present selection.

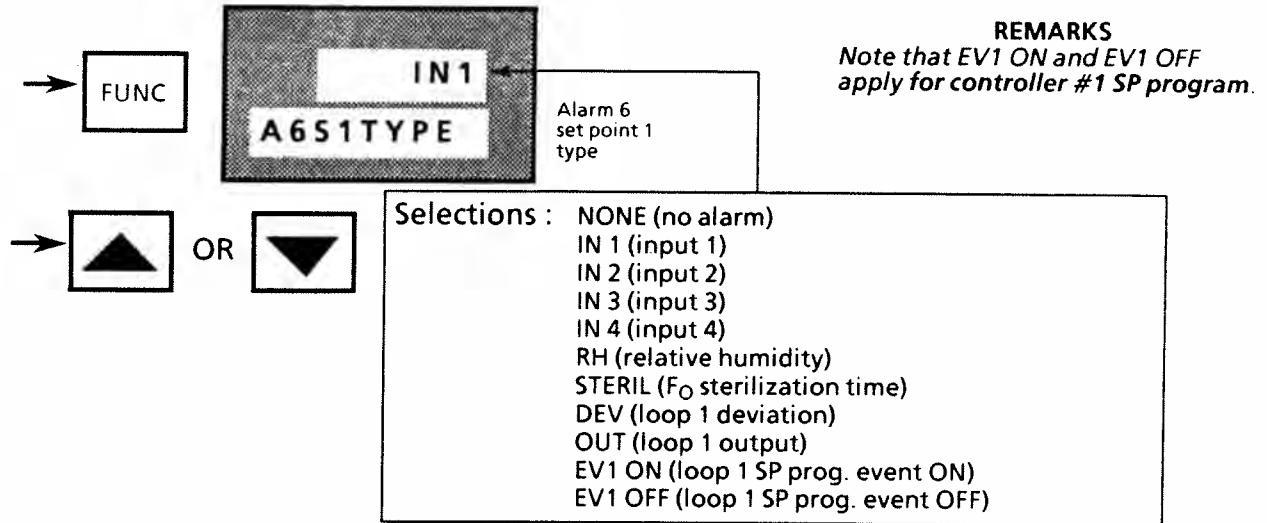

97. Use [RAISE] or [LOWER] key to select desired set point 1 alarm 6 type, or go to Step 98. Note that some selections may not appear, depending on your recorder model.

98. Press [FUNC] key to call up next parameter and enter present selection.

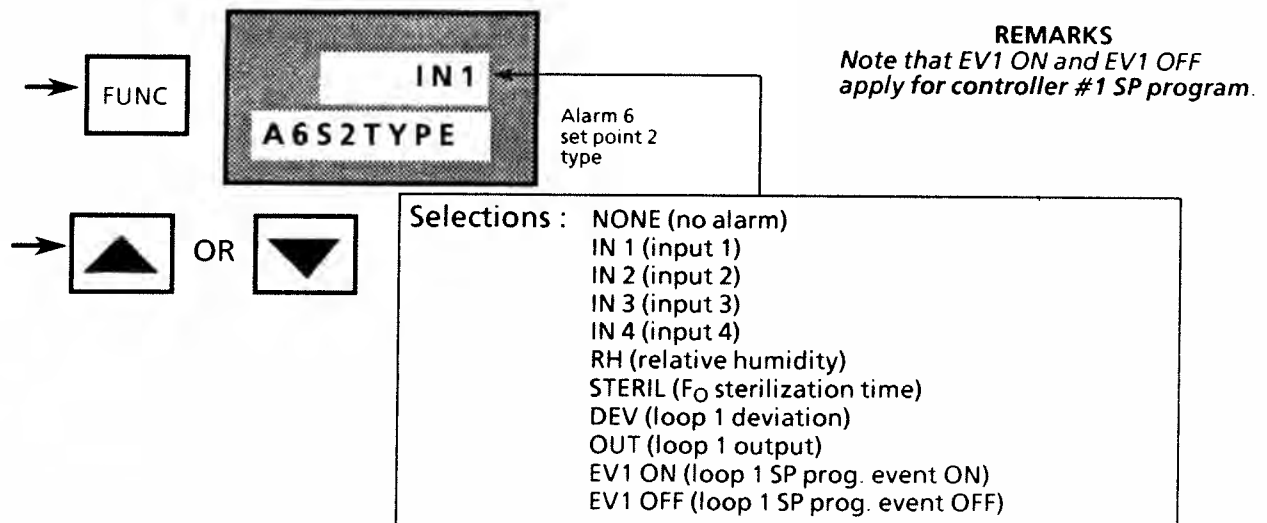

99. Use [RAISE] or [LOWER] key to select desired set point 2 alarm 6 type, or go to Step 100. Note that some selections may not appear, depending on your recorder model.

D-3. ALARMS Configuration -- Continued

100. Press [FUNC] key to call up next parameter and enter present selection.

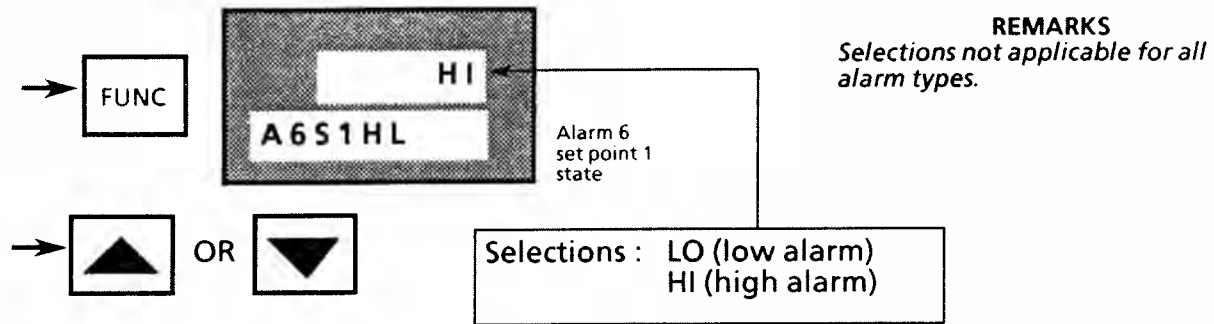

101. Use [RAISE] or [LOWER] key to select applicable set point 1 alarm 6 state, or go to Step 102.

102. Press [FUNC] key to call up next parameter and enter present selection.

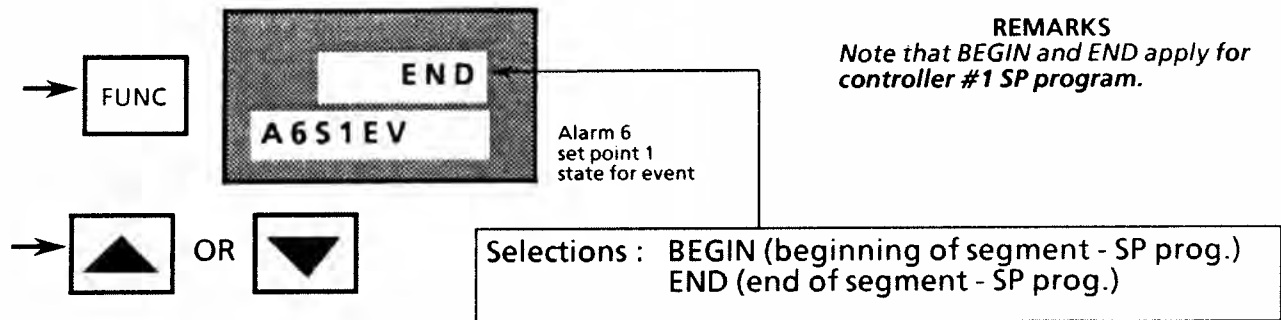

103. Use [RAISE] or [LOWER] key to select applicable set point 1 alarm 6 state for event, or go to Step 104.

D-3. ALARMS Configuration -- Continued

104. Press [FUNC] key to call up next parameter and enter present selection.

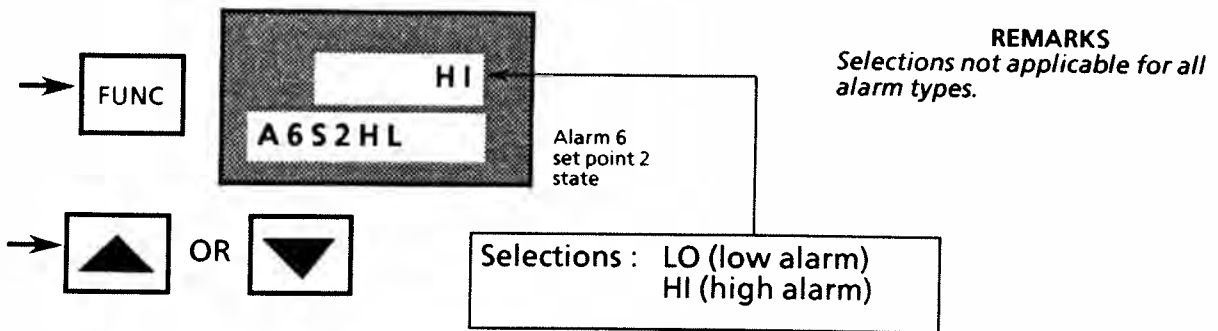

105. Use [RAISE] or [LOWER] key to select applicable set point 2 alarm 6 state, or go to Step 106.

106. Press [FUNC] key to call up next parameter and enter present selection.

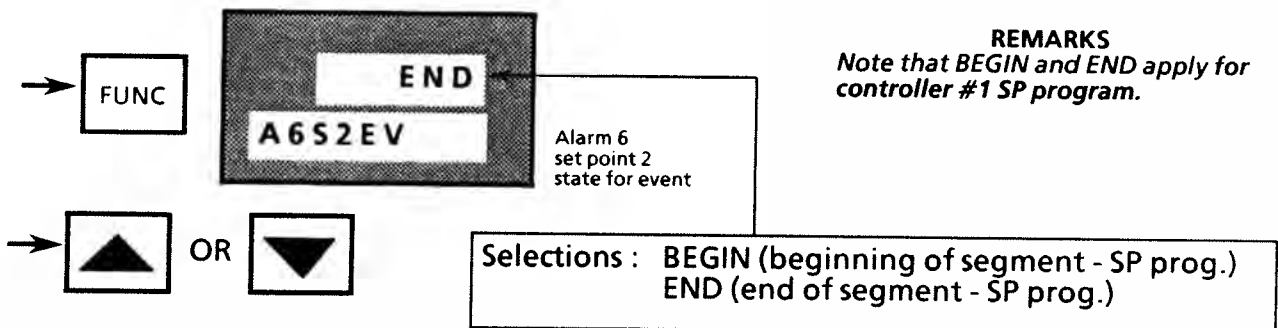

107. Use [RAISE] or [LOWER] key to select applicable set point 2 alarm 6 state for event, or go to Step 108.

D-3. ALARMS Configuration -- Continued

108. Press [FUNC] key to call up next parameter and enter present selection.

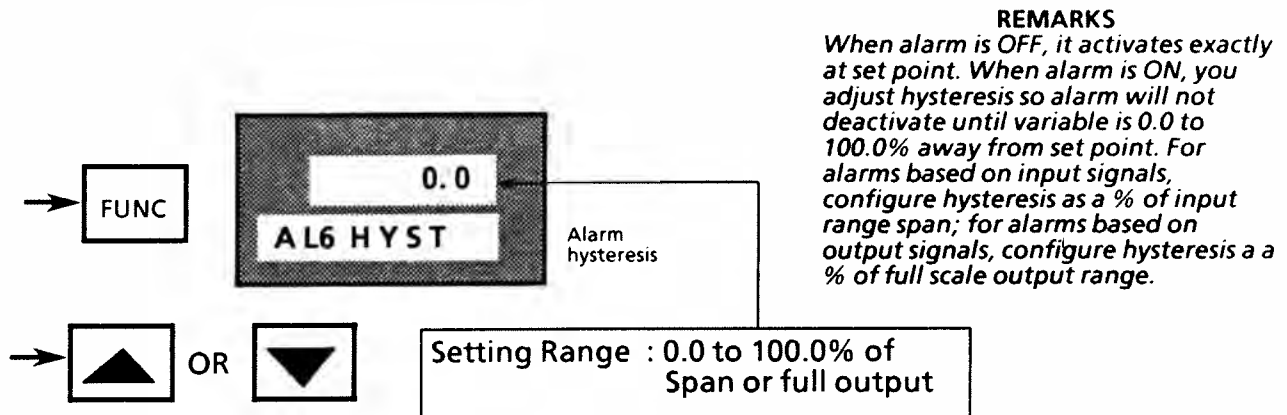

109. Use [RAISE] or [LOWER] key to set hysteresis for alarm action, or go to Step 110.

110. Press [SET UP] key to call up next group prompt and go to appropriate procedure in this section. Or, press [LOWR DISP] key to exit Configuration Mode.

D-4. EVENT MESSAGE Configuration

Prerequisites:

- Key Number = DR 450R
- Recorder door is open and power is ON.
- Keypad LOCKOUT configuration is NONE.

1. Press [SET UP] key to put recorder in Configuration (SET UP) Mode and call up EVNT MSG prompt in lower display. If recorder is in SET UP Mode, successively press [SET UP] key to step through group prompts or hold key in to scroll prompts until EVNT MSG appears in display.



REMARKS
If you want to abort (exit) configuration mode, press [LOWR DISP] key or don't press any key for 1 minute.

2. Press [FUNC] key to call up first event message parameter for configuration.

NOTE: Hold key in if you want to scroll through all the function prompts associated with this group.

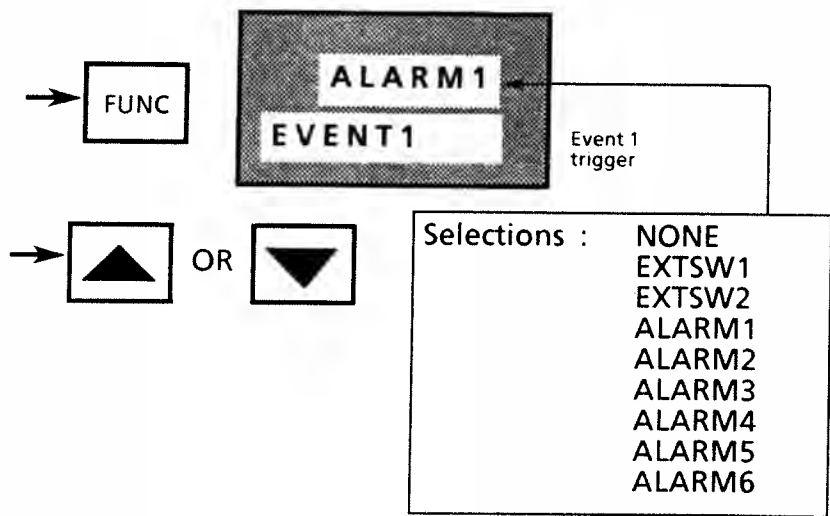

3. Use [RAISE] or [LOWER] key to select actuation to trigger event 1 message.
 - If you select NONE, go to Step 8; otherwise, go to Step 4.

D-4. EVENT MESSAGE Configuration -- Continued

NOTE: To recall original value or selection, press [RUN/HOLD] key before pressing [FUNC] key again.

4. Press [FUNC] key to call up next parameter and enter present selection.

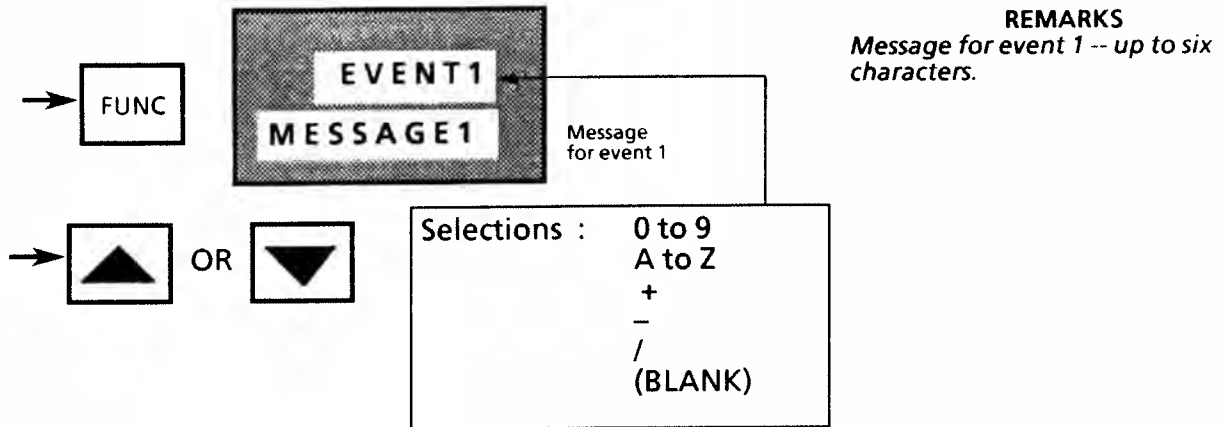

NOTE: For alphanumeric entries, the display will cycle, from left to right, with highlighting (increased brightness) of each digit. The value of each digit can be changed only when it is highlighted.

5. Use [RAISE] or [LOWER] key to enter desired message for event 1, or go to Step 6.
6. Press [FUNC] key to call up next parameter and enter present selection.

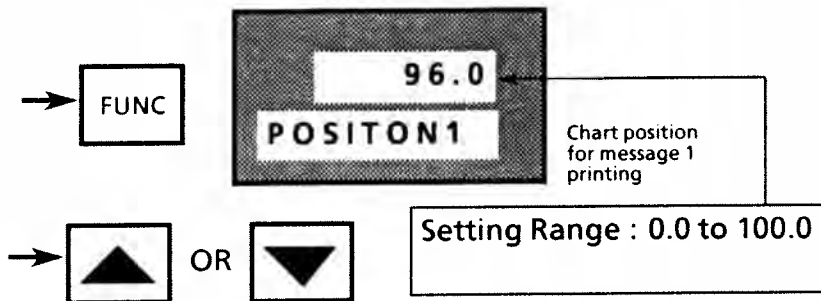

7. Use [RAISE] or [LOWER] key to set desired chart position for message 1 printing when triggered by event 1, or go to Step 8.

D-4. EVENT MESSAGE Configuration -- Continued

8. Press [FUNC] key to call up next parameter and enter present selection.

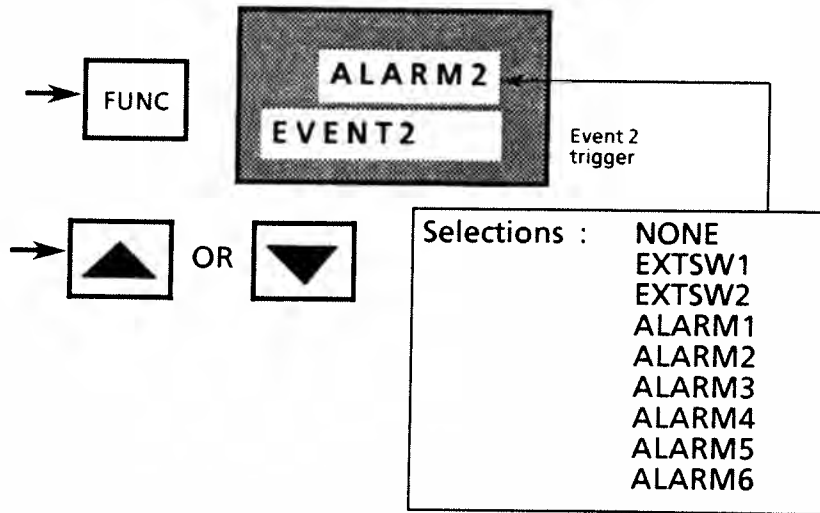

9. Use [RAISE] or [LOWER] key to select actuation to trigger event 2 message.

- If you select NONE, go to Step 14; otherwise, go to Step 10.

10. Press [FUNC] key to call up next parameter and enter present selection.

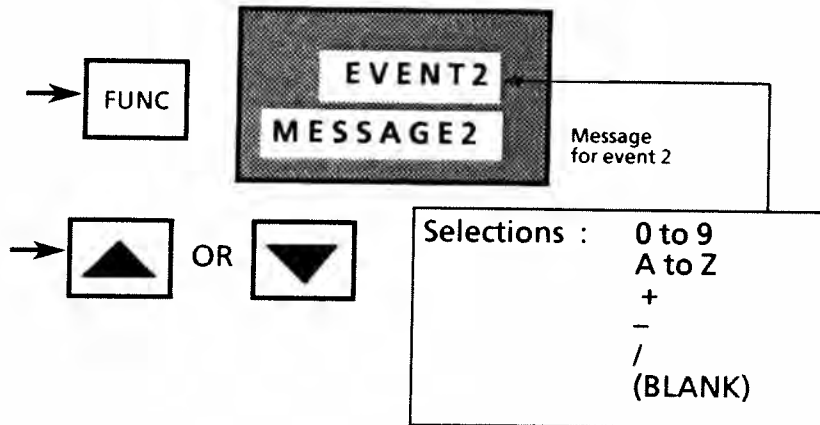

REMARKS
 Message for event 2 -- up to six characters.

NOTE: For alphanumeric entries, the display will cycle, from left to right, with highlighting (increased brightness) of each digit. The value of each digit can be changed only when it is highlighted.

11. Use [RAISE] or [LOWER] key to enter desired message for event 2, or go to Step 12.

D-4. EVENT MESSAGE Configuration -- Continued

12. Press [FUNC] key to call up next parameter and enter present selection.

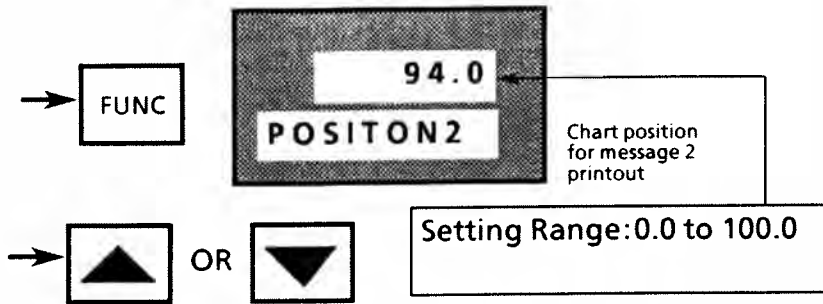

13. Use [RAISE] or [LOWER] key to set desired chart position for message 2 printing when triggered by event 2, or go to Step 14.

14. Press [FUNC] key to call up next parameter and enter present selection.

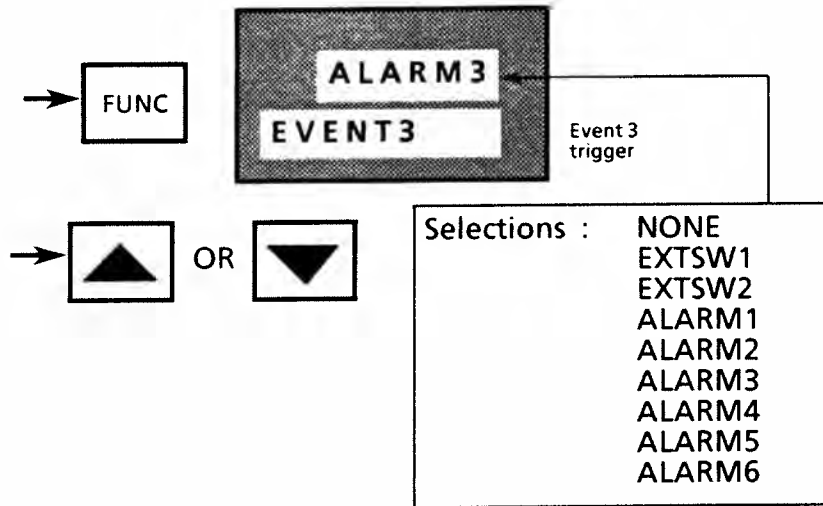

15. Use [RAISE] or [LOWER] key to select actuation to trigger event 3 message.
 • If you select NONE, go to Step 20; otherwise, go to Step 16.

D-4. EVENT MESSAGE Configuration -- Continued

16. Press [FUNC] key to call up next parameter and enter present selection.

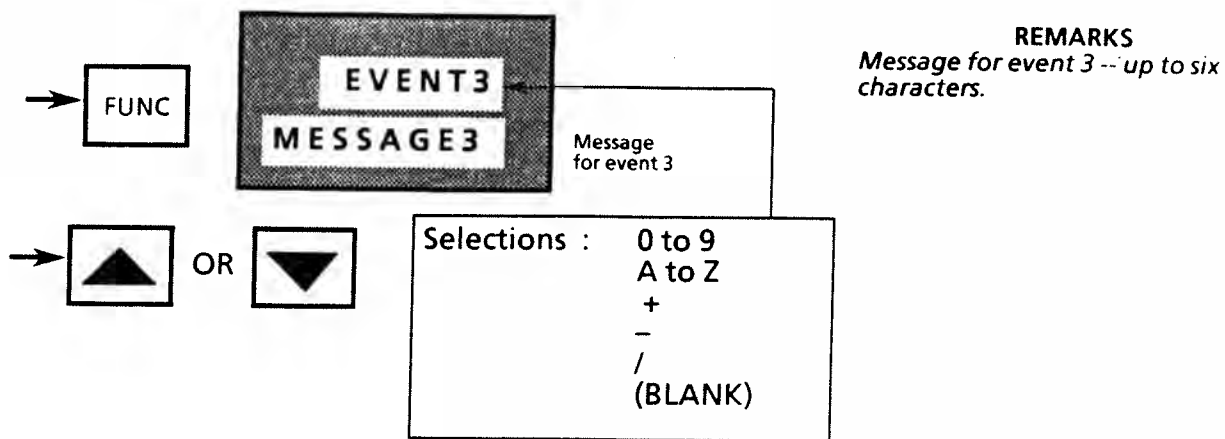

NOTE: For alphanumeric entries, the display will cycle, from left to right, with highlighting (increased brightness) of each digit. The value of each digit can be changed only when it is highlighted.

17. Use [RAISE] or [LOWER] key to enter desired message for event 3, or go to Step 18.

18. Press [FUNC] key to call up next parameter and enter present selection.

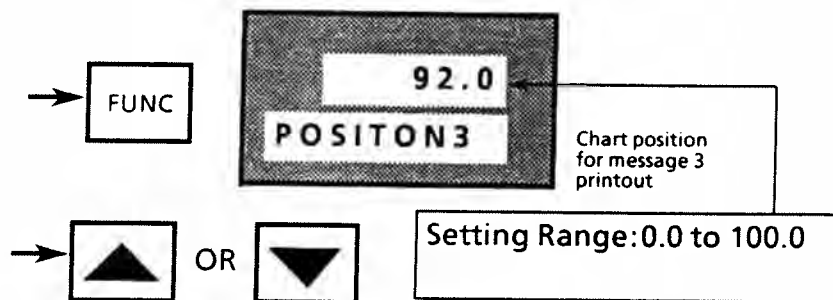

19. Use [RAISE] or [LOWER] key to set desired chart position for message 3 printing when triggered by event 3, or go to Step 20.

D-4. EVENT MESSAGE Configuration -- Continued

20. Press [FUNC] key to call up next parameter and enter present selection.

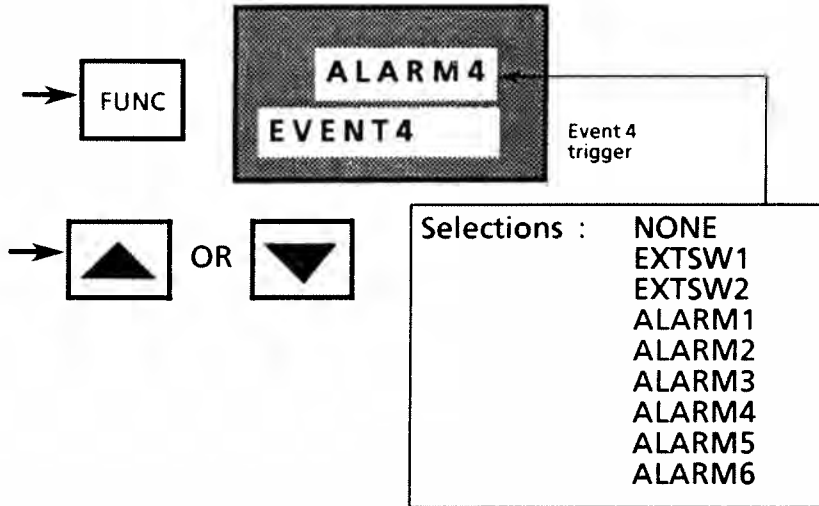

21. Use [RAISE] or [LOWER] key to select actuation to trigger event 4 message.

- If you select NONE, go to Step 26; otherwise, go to Step 22.

22. Press [FUNC] key to call up next parameter and enter present selection.

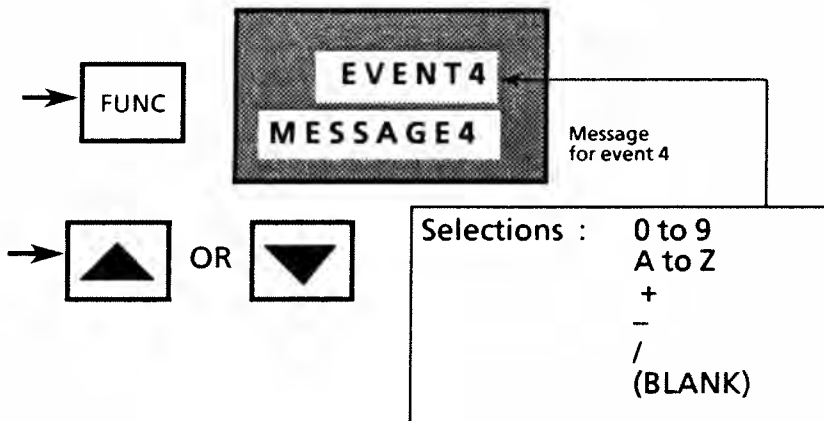

REMARKS
 Message for event 4 -- up to six characters.

NOTE: For alphanumeric entries, the display will cycle, from left to right, with highlighting (increased brightness) of each digit. The value of each digit can be changed only when it is highlighted.

23. Use [RAISE] or [LOWER] key to enter desired message for event 4, or go to Step 24.

D-4. EVENT MESSAGE Configuration -- Continued

24. Press [FUNC] key to call up next parameter and enter present selection.

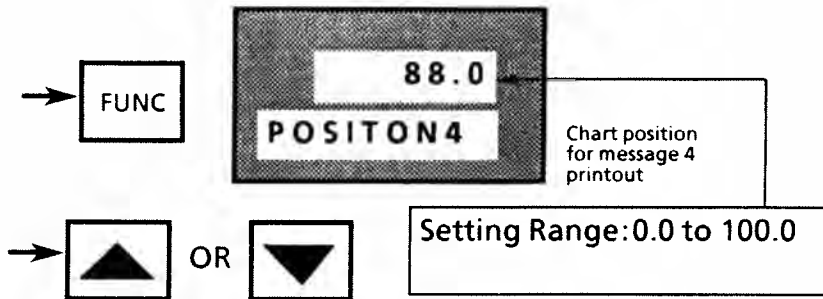

25. Use [RAISE] or [LOWER] key to set desired chart position for message 4 printing when triggered by event 4, or go to Step 26.

26. Press [FUNC] key to call up next parameter and enter present selection.

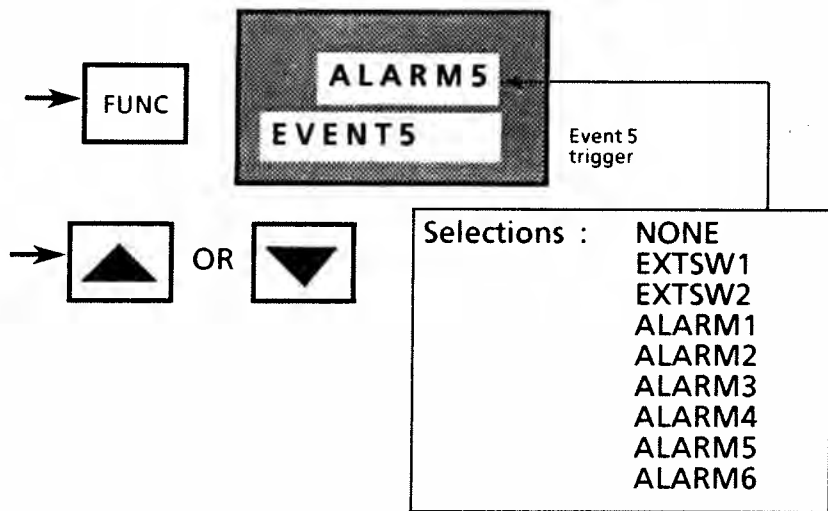

27. Use [RAISE] or [LOWER] key to select actuation to trigger event 5 message.
 • If you select NONE, go to Step 32; otherwise, go to Step 28.

D-4. EVENT MESSAGE Configuration -- Continued

28. Press [FUNC] key to call up next parameter and enter present selection.

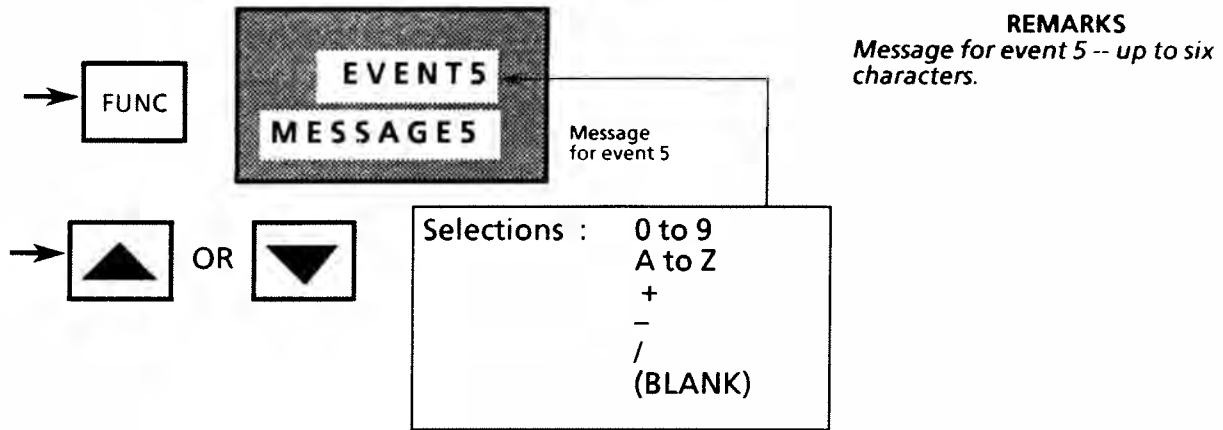

NOTE: For alphanumeric entries, the display will cycle, from left to right, with highlighting (increased brightness) of each digit. The value of each digit can be changed only when it is highlighted.

29. Use [RAISE] or [LOWER] key to enter desired message for event 5, or go to Step 30.

30. Press [FUNC] key to call up next parameter and enter present selection.

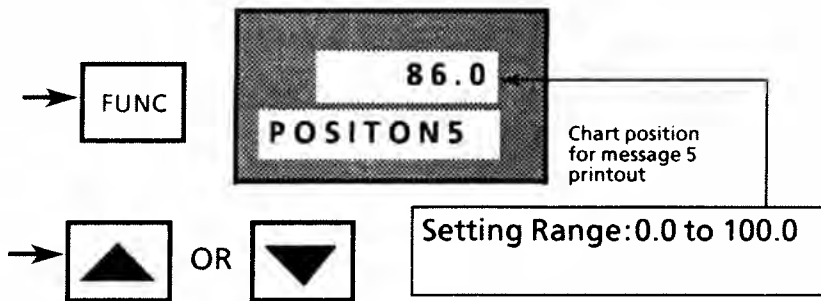

31. Use [RAISE] or [LOWER] key to set desired chart position for message 5 printing when triggered by event 5, or go to Step 32.

D-4. EVENT MESSAGE Configuration -- Continued

32. Press [FUNC] key to call up next parameter and enter present selection.

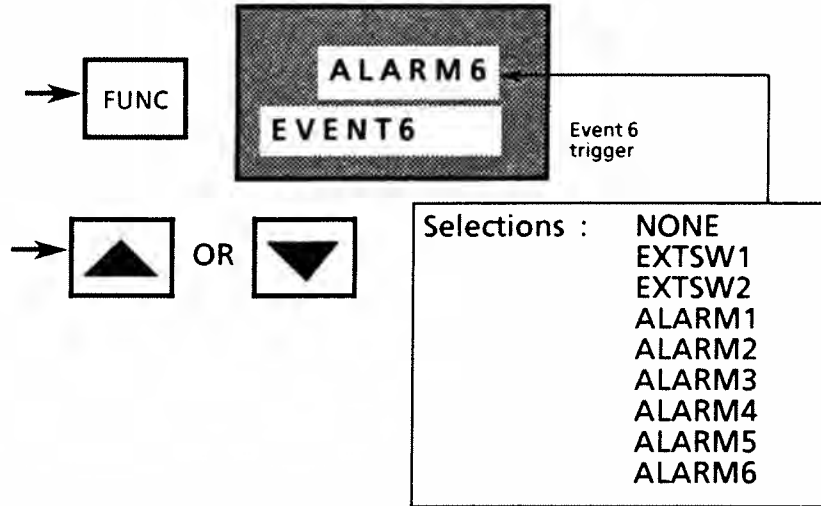

33. Use [RAISE] or [LOWER] key to select actuation to trigger event 6 message.

- If you select NONE, go to Step 38; otherwise, go to Step 34.

34. Press [FUNC] key to call up next parameter and enter present selection.

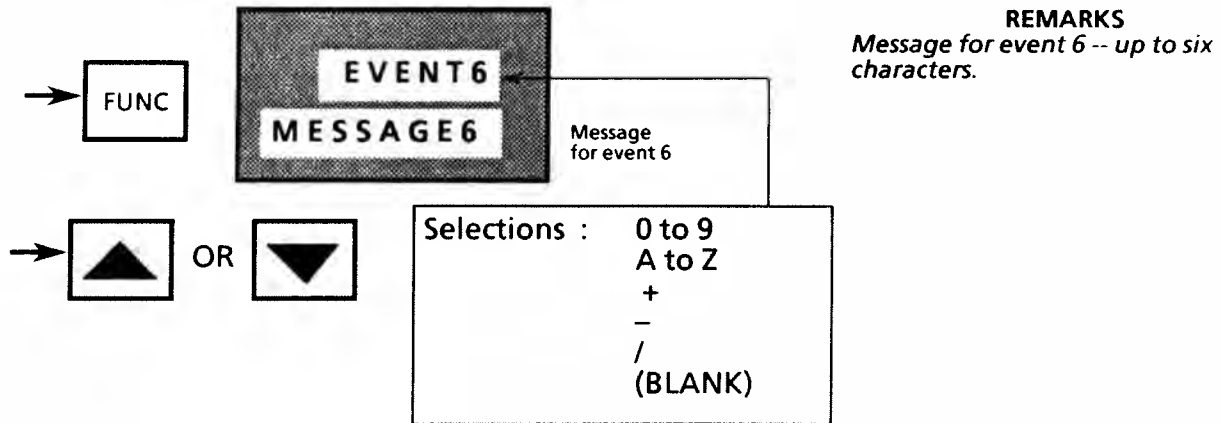

NOTE: For alphanumeric entries, the display will cycle, from left to right, with highlighting (increased brightness) of each digit. The value of each digit can be changed only when it is highlighted.

35. Use [RAISE] or [LOWER] key to enter desired message for event 6, or go to Step 36.

D-4. EVENT MESSAGE Configuration -- Continued

36. Press [FUNC] key to call up next parameter and enter present selection.

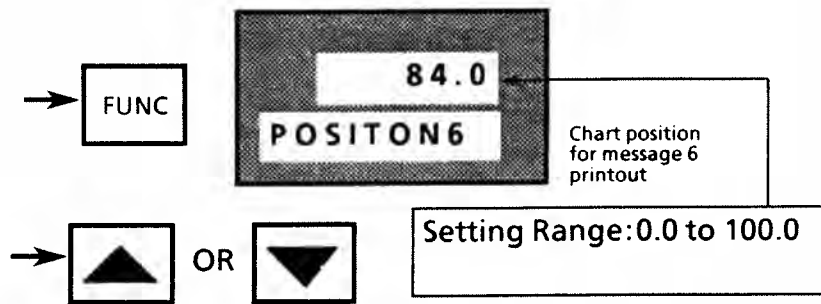

37. Use [RAISE] or [LOWER] key to set desired chart position for message 6 printing when triggered by event 6, or go to Step 38.
38. Press [SET UP] key to call up next group prompt and go to appropriate procedure in this section. Or, press [LOWR DISP] key to exit Configuration Mode.

5. Operation Additions

Add the following to table for Viewing Displays on page 5-5:

Prompt	Parameter Definition
F ₀	F ₀ sterilization time in lower display with appropriate input in upper display.

Add the following to table for Closing Remote Contact (Switch) on page 5-13:

REM SW Prompt Selection	Action on Contact Closure	Display Indication
FO RST	Resets F ₀ sterilization calculation -- if FO RESET prompt is enabled.	NONE

6. Worksheet Additions

Use worksheet on next page to identify prompts unique to model DR 450R recorder.

Configuration Worksheet DR 450R Truline Recorder

Group Prompt	Function Prompt	Value or Selection
ALARMS	A1S1 VAL	
	A1S2 VAL	
	A1S1 TYPE	
	A1S2 TYPE	
	A1S1 HL	
	A1S1 EV	
	A1S2 HL	
	A1S2 EV	
	AL1 HYST	
	A2S1 VAL	
	A2S2 VAL	
	A2S1 TYPE	
	A2S2 TYPE	
	A2S1 HL	
	A2S1 EV	
	A2S2 HL	
	A2S2 EV	
	AL2 HYST	
	A3S1 VAL	
	A3S2 VAL	
	A3S1 TYPE	
	A3S2 TYPE	
	A3S1 HL	
	A3S1 EV	
	A3S2 HL	
	A3S2 EV	
	AL3 HYST	
	A4S1 VAL	
	A4S2 VAL	
	A4S1 TYPE	
	A4S2 TYPE	
	A4S1 HL	
	A4S1 EV	
	A4S2 HL	
	A4S2 EV	
	AL4 HYST	
	A5S1 VAL	
	A5S2 VAL	
	A5S1 TYPE	
	A5S2 TYPE	
A5S1 HL		
A5S1 EV		

Group Prompt	Function Prompt	Value or Selection	
ALARMS (continued)	A5S2 HL		
	A5S2 EV		
	AL5 HYST		
	A6S1 VAL		
	A6S2 VAL		
	A6S1 TYPE		
	A6S2 TYPE		
	A6S1 HL		
	A6S1 EV		
	A6S2 HL		
	A6S2 EV		
	AL6 HYST		
	EVNT MSG	EVENT 1	
		MESSAGE 1	
POSITON 1			
EVENT 2			
MESSAGE 2			
POSITON 2			
EVENT 3			
MESSAGE 3			
POSITON 3			
EVENT 4			
MESSAGE 4			
POSITON 4			
LOCKOUT	PASSWORD		
	LOCKOUT		
	CHANGE		
FO RESET	RESET FO		
OPTIONS	STERILIZ		
	IN TEMP		
	STD TEMP		
	Z VALUE		
	REM SW		
	REM SW2		

DR 4500 Truline Circular Chart Recorder

Specification

Function

Honeywell's Truline recorder is a one to four-channel microprocessor-based, circular chart recorder. Its "one-pen" stylus printhead produces up to four analog traces and prints alphanumeric chart data on a blank heat-sensitive chart. All four traces share the *same time line* reference which the Truline prints. This eliminates the error caused by pen alignment offsets in conventional pen designs. Since the Truline prints the chart and generates the analog traces at the same time, there is no error due to variations in chart size caused by changes in temperature and humidity.

With microprocessor electronics and single printhead, the Truline recorder is easily configured by users to meet a variety of application requirements -- from metals to food processing. In addition to printing informative, accurate chart records, the Truline recorder alternately displays process variable values for all channels in the selected engineering units.

Models with up to four input channels accept inputs from any one of a variety of sensors or transmitters within the configurable range limits. Also, models are available with one or two independent digital controllers to generate controlled output signals to operate valves, dampers, heating elements, etc. for process control.

Features

- User configurable means the users can set and/or alter operating parameters to fit their requirements including type of input without recalibration.
- English language prompts coupled with simple keystroke sequences make configuring the recorder easy and straightforward.
- Comprehensive operator interface includes clear, brilliant alphanumeric displays, indicators, deviation bargraph, and keypad for visual and tactile interaction.
- One all-purpose blank chart eliminates the need for ordering and stocking several types of charts. And, users can design the chart to match their specific application.

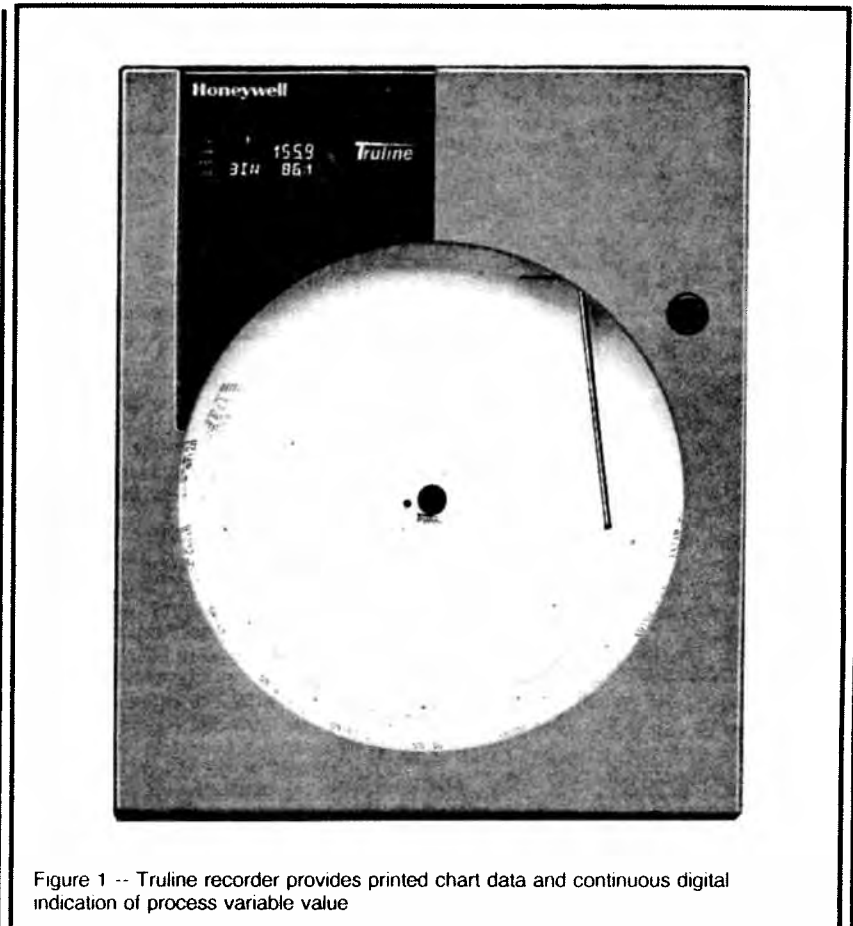

Figure 1 -- Truline recorder provides printed chart data and continuous digital indication of process variable value

- Up to four channels for monitoring process variables from a variety of sensor types helps reduce panel space requirements.
- "One-pen" printer prints configurable alphanumeric chart data including time and trend lines. This automatically compensates for chart width variations caused by changes in the ambient relative humidity.
- Real-time, clock, dates time of printing (hour, minutes, date and year) and any operator changes in real time to guard against unauthorized chart advancement.
- Up to two versatile PID digital controllers let users configure the exact control action needed for their process.
- A single set point ramp is user programmable and it is easily repeated and activated through the Run/Hold key.
- Up to six integral "soft" alarms are easily set by users to announce selected, out-of-limit conditions.
- Optional DMCS communication card supports bi-directional communication link between the recorder and host computer.

User Configurable

In the DR 4500 Series recorder, microprocessor control replaces conventional electro-mechanical recording techniques. This means that the recorder's capabilities are now primarily determined by its software. Since Honeywell has

preprogrammed a variety of functional capabilities into the recorder, a user only has to configure those functions that are specific for the given application. The user configures the recorder by following English language prompts in the digital displays.

The configuration data (type of input, chart speed, chart range, alarm settings, tuning constants, etc.) are stored in nonvolatile memory for safe keeping in the event of a power failure.

Operator Interface

Two digital displays present the process variable (PV) value and by key selection, the controller set point; controller output; deviation from reference input; dry bulb temperature; totalization value; or engineering units as desired. In configuration mode, digital displays are pre-empted by English language prompts and values for entering configuration data.

Indicators light to show alarm condition, which channel PV is on display, use of remote set point, which output relay is on, selected temperature unit, and controller's mode of operation. Deviation bargraph lets operators tell at a glance if the process variable is at, above, or below the controller's set point.

The keypad through which configuration data is entered also serves as an integral automatic/manual station that provides bumpless transfer for controllers.

Microprocessor Controlled Recording and Printing

Both the chart and the printhead are driven by stepper motors controlled by the microprocessor for precise maintenance free operation.

Since chart speed is configurable, users can easily alter the chart speed through the keypad -- gear changing or additional motors are no longer required.

The microprocessor uses the configured chart range data as well as the input data to determine the proper printhead position. The stepper motor accurately positions the printhead drive.

By using a "one-pen" printhead that is capable of printing alphanumeric characters, users can now set various "printed" chart data through configuration. This means that such chart data as range marking in engineering units, digital values for process variables, and trace identification are easily personalized for the application. This data plus printed time lines and engineering units of scale eliminate the need to maintain an inventory of a variety of preprinted charts.

The Truline recorder uses a dot fill technique from a microprocessor algorithm to produce a continuous analog trace of a process variable.

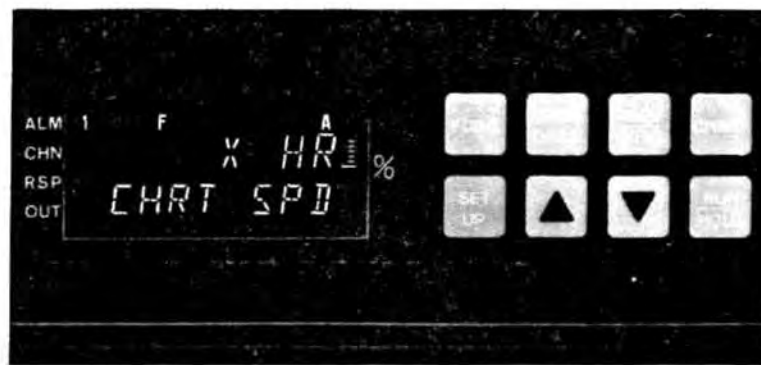

Figure 2 -- Operator interface includes displays and keypad for comprehensive interaction with the recorder and the process

Time/Date

An integral real-time clock provides accurate timing for the recorder's time and date printing. A 10-year life battery backup assures correct timing even when power fails.

Input Processing

The input can be one of many standard low-level electrical signals. Since inputs are isolated, users can connect different types of input signals to multi-channel models in any combination. And, for models with 2 or more channels, a relative humidity (wet/dry bulb) actuation is available using 100 ohm platinum bulbs ($\alpha = 0.00385$). The input type and range are user configurable for hassle free actuation changes in the field. Ranges are easily expanded and compressed within their span limitations to meet specific measurement needs. Users can select upscale or downscale sensor break protection for many of the actuations.

Each input is sampled at a rate of 3 times per second for 1 or 2 inputs, or 3 times in 2 seconds for 3 or 4 inputs. Each sample is amplified and then converted to a digital signal which is isolated and passed to the microprocessor. A digital filter with configurable time constants lets users apply input signal smoothing as desired. All non-linear inputs are linearized by the microprocessor.

An integral 24 Vdc power supply along with 4-20 mA input configuration allows direct operation with up to two transmitters without the need for any additional/external transmitter power supply.

To totalize a variable, such as a flow signal, users select the applicable input and set the digital display scaling factor through configuration. This eliminates the need for additional integration hardware including a mechanical counter. The totalizer has an eight digit display and 14 digit printing on the chart.

Digital Controller

The DR 4500 Series recorder controller includes an integral microprocessor-based, single-loop, PID controller. A variety of output types, including a duplex variation for heat-cool applications, lets users select the output that is right for their final control element. Depending on the output type users can configure the control action as on-off, PID-A, PID-B, PD with manual reset, or 3 position step control. As with the record functions, English language prompts quickly guide users through the entry of all the controller's configurable parameters.

Diagnostics

All DR 4500 Series recorders include self-diagnostic systems that check critical operations and provide error messages to alert users about detected faults.

Power-up self-diagnostics is a microprocessor controlled diagnostic program that runs tests on selected circuitry when the recorder is powered up.

A "key" test allows a user to initiate on demand a self-diagnostic routine that checks the keypad and front panel displays.

Construction

The DR 4500 Series recorder is housed in a molded case which can be panel or surface mounted. A glass (polycarbonate optional) windowed, gasketed door protects internal components from harsh industrial environments while allowing easy access to the chart and operator interface. Circuitry is partitioned on printed circuit boards for ease of service. A NEMA 4X Stainless Steel door is available as an option.

Process Interface

Power, input and output wiring connect to terminations inside the case. Knockouts in the sides and bottom of the case accept conduit connections for convenient wire entry.

Options*

- **Chart Illumination** -- Lights the chart area to improve readability in lower light areas.
- **Alarm Output** -- Ties "soft" alarms to up to six integral SPST relays to activate users external equipment.
- **Digital Input** -- Allows users to initiate selected recorder functions, such as switching from automatic to manual control mode, from direct to reverse controller action, or marking an event, from remote location through two dry contact closures.
- **DMCS Communication** -- Allows integration between recorder and host computer.

*Restrictions apply -- Not all of the options can be supplied together.

- **Set Point Ramp/Soak Programming** -- Lets users program and store 6 ramp and 6 soak segments. Run or Hold of program is keyboard or remote switch selectable.
- **Control** -- Two digital controllers available
- **Plastic Window**
- **Door Lock**
- **NEMA 4X Door**
- **UL Listing**
- **Customer ID Tag**
- **DR450R Model** for up to 6 relays and F_o calculation
- **DR450W Flow Model** for Weir and Parshall flume calculations and up to 4 totalizers
- **DR450H High Temperature Short Time (HTST) Model** for the dairy industry with lead seal provisions and FDA compliance

Specifications

Design

Digital Indication Accuracy	1 digit
Minimum Input Span	Range is fully configurable with span limitation of the operating range selected.
Input Impedance	4-20 mAdc: 250 ohms 0-10 Vdc: 200K ohms All others: 10 Megohms
Source Impedance	RTD: 100 ohms per lead maximum
Span Step Response Time	6 seconds maximum with no filtering
Sampling Rate	Each input sampled 3 times a second (1 or 2 inputs); 3 times in 2 seconds (3 or 4 inputs).
Input Filter	Software: Single pole low pass section with selectable time constants (off to 120 seconds).
Digital Displays	Vacuum fluorescent, alphanumeric. A six digit display dedicated to the process variable. Alternate information displayed during configuration mode. An eight digit display shows key selected operating parameters. Also provides guidance during configuration.
Indicators	Channel PV display (CHN 1, 2, 3, or 4) Alarm status (ALM 1, 2) Controller Output (OUT 1 or 2) Remote Set Point (RSP) Temperature unit (F or C) or Engineering units Controller's mode (A or MAN)
Deviation Bargraph	21 segment, color coded deviation bargraph: Green = On Control Red = Deviation to $\pm 10\%$ of PV
Controller Modes of Operation	Manual Operation Automatic with local set point Automatic with remote set point
Transmitter Supply Voltage	22 to 26 Vdc at input terminals (50 mAdc at 24 Vdc)

Specifications

Performance

Number of Inputs
One channel model: One input
Two channel model: Two inputs
Three channel model: Three inputs
Four channel model: Four inputs

Types of Input Actuation ¹

	Range		Reference Accuracy		Temp. Stability ± Degrees Error Per 1 Degree ΔT
	°F	°C	± °F	± °C	
Thermocouples²					
B	105 to 3300	41 to 1816			
	105 to 150	41 to 66	42.00	23.00	2.00
	150 to 500	66 to 260	14.00	7.70	2.00
	500 to 1000	260 to 538	3.00	1.70	0.50
	1000 to 3300	538 to 1816	1.50	0.80	0.20
E	-454 to 1832	-270 to 1000			
	-454 to -202	-270 to -130	18.00	10.00	0.70
	-202 to 1832	-130 to 1000	1.00	0.55	0.35
E (low)	-200 to 1100	-129 to 593	0.50	0.30	0.20
J	0 to 1600	-18 to 871	0.40	0.22	0.06
J (low)	20 to 770	-7 to 410	0.20	0.11	0.04
K	-320 to 2500	-196 to 1371			
	-320 to 0	-196 to -18	1.25	0.70	0.18
	0 to 2500	-18 to 1371	0.60	0.35	0.09
K (low)	-20 to 1000	-29 to 538	0.30	0.16	0.05
NNM (Ni Ni Moly)	32 to 2500	0 to 1371			
	32 to 500	0 to 260	0.75	0.40	0.09
	500 to 2500	260 to 1371	0.50	0.30	0.07
NIC (Nicrosil Nisil)	0 to 2372	-18 to 1300	1.0	0.55	0.01
R	0 to 3100	-18 to 1704			
	0 to 500	-18 to 260	2.00	1.10	0.25
	500 to 3100	260 to 1704	1.00	0.55	0.13
S	0 to 3100	-18 to 1704			
	0 to 500	-18 to 260	2.00	1.10	0.23
	500 to 3100	260 to 1704	1.00	0.55	0.13
T	-300 to 700	-184 to 371	0.60	0.35	0.07
T (low)	-200 to 600	-129 to 316	0.40	0.22	0.07
W5W26	0 to 4200	-18 to 2315			
	0 to 600	-18 to 316	1.40	0.77	0.17
	600 to 3600	316 to 1982	1.30	0.70	0.17
	3600 to 4200	1982 to 2315	1.60	0.90	0.29
W5W26 (low)	0 to 2240	-18 to 1227			
	0 to 600	-18 to 316	1.10	0.60	0.14
	600 to 2240	316 to 1227	1.00	0.55	0.10

Specifications (continued)

Types of Input Actuation ¹	Range		Reference Accuracy		Temp. Stability ± Degrees Error Per 1 Degree ΔT	
	°F	°C	± °F	± °C		
RTDs						
Platinum*						
100 ohms	-300 to 900	-184 to 482	0.40	0.22	0.05	
200 ohms (High)**	32 to 752	0 to 400	0.30	0.16	0.05	
200 ohms (Low)**	32 to 392	0 to 200	0.20	0.12	0.05	
500 ohms	-300 to 900	-184 to 482	0.20	0.11	0.05	
Linear						
Milliamperes dc	4 to 20	--	0.10%	--	0.004%/°F	
Millivolts dc	0 to 10	--	0.05%	--	0.004%/°F	
	10 to 50	--	0.05%	--	0.004%/°F	
Volts dc	1 to 5 (can be calibrated 0 to 5)	--	0.05%	--	0.004%/°F	
	0 to 10	--	0.10%	--	0.004%/°F	
Relative Humidity						
Platinum 100 ohm Wet/Dry Bulb*	Wet/Dry Input	-130 to 392	-90 to 200	0.30	0.20	0.03
	%RH ³	Measured %RH	Dry Bulb Range °F °C	Reference Accuracy ± °F ± °C	Temp. Stability 53 to 104°F/ 12 to 40°C	
		0 to <20	-103 to 212 -75 to 100	2% RH	0.11% RH/°F	
		20 to 100	35 to 40 2 to 4	2% RH	0.11% RH/°F	
			>40 to 100 >4 to 38	1% RH	0.06% RH/°F	
			100 to 212 38 to 100	1% RH	0.03% RH/°F	

¹Not all Input Actuators are available on all models of the Truline Recorder. Consult Model Selection Guide for information.

²Includes reference junction calibration of ±0.01 degrees using standard "ice bath" method of calibration. Factory calibration at reference ±1.2°F. Note that factory calibration may vary by as much as ±10 microvolts or ±0.3 ohms for RTDs which means recalibration may be required to achieve stated accuracy.

³The RH calculation is inoperative when temperature goes below 32°F (0°C) or above 212 °F (100 °C). However, the dry bulb temperature will be monitored to -103°F (-75°C). Accuracy stated is for Truline Recorder only and does not include remaining system accuracies.

*IEC Alpha (α) = 0.00385 Ω / Ω /°C

**Only available with Model DR450R

Specifications (continued)

Configurable Parameters: These parameters can be set through the keypad for Recorder DR450T -- Different parameters apply for DR450R, DR450W and DR450H Models.

GROUP	PARAMETERS	SETTING RANGE OR SELECTION	RESOLUTION
TUNING1 (2)	Gain (or Prop Band) Rate Min (or RPM) Reset Min MAN RSET CYC SEC	0.1 to 1000 0.00 to 10.00 0.02 to 50.00 -100 to 100% output 1 to 120 sec.	0.1 0.01 0.01 1 1
SPRAMP 1 (2)	SP Ramp (1 or 2) Time Min Final SP SP Program Start Segment End Segment Recycle (1 or 2) Soak Deviation Segment 1 Ramp (3,5,7,9,11) Segment 2 Ramp (4,6,8,10,12) Segment 2 Time (4,6,8,10,12) Program End State Ramp Unit	Disable or Enable 0 to 255 0 to 100% of Span Disable or Enable 1 to 12 2,4,6,8,10,12 0 to 99 0.0 to 99.0 0.00 to 99.59 0.0 to 500 0.00 to 99.59 Last SP or Failsafe Disable or Hold Time or Rate	1
CHART	Chart speed Hours per revolution Time Div Continue Chart Name Header Rem Chart Wake Minute Wake Hour	8 hrs, 24 hrs, 7 days, or selected hours per revolution 6 to 744 hrs 8 to 24 Yes or No (Chart rotation beyond 360 degrees) Up to six characters Yes or No None, Extsw1, Extsw2, Alarm1, Alarm2, Time, Shed 0 to 59 0 to 23	
TIME	Minutes Hours Day Month Year Day	1 to 59 0 to 23 1 to 31 1 to 12 4-digits Monday to Sunday	
PEN 1	Pen 1 Pen 1 input Chart 1 high range value Chart 1 low range value Major chart division Minor chart division Range 1 Tag Pen 1 On Pen 1 Off	Disable or Enable Input 1, Output, SP, Dgt1 or Dgt2 -999.0 to 9999 -999.0 to 9999 2 to 10 2 to 10 Up to five characters 0 to 100% of chart 0 to 100% of chart	0.1 0.1 1 1
PEN 2	SAME AS PEN 1 -- except for Input 2		
PEN 3	SAME AS PEN 1 -- except for Input 3		
PEN 4	SAME AS PEN 1 -- except for Input 4		

Specifications (continued)

GROUP	PARAMETERS	SETTING RANGE OR SELECTION	RESOLUTION
INPUT 1	Decimal point location	None, 1 (XXX.X), 2 (XX.XX), or 3 (X.XXX) -- one decimal place only for non-linear inputs	
	Units	°F, °C or engineering units	
	Actuation type	See input types	
	Transmitter characterization	All non-linear input types, linear, square root	
	High range value	-999.0 to 9999	0.1
	Low range value	-999.0 to 9999	0.1
	Input compensation	-999.0 to 9999	0.1
	Filter 1	0 to 120	1
	Sensor break protection (burnout)	None, Up or Down	
INPUT 2	SAME AS INPUT 1		
INPUT 3	SAME AS INPUT 1		
INPUT 4	SAME AS INPUT 1		
TOTAL 1	Total	Read only	
	Reset total	Yes or No	
	Total 1	Disable or Enable	
	Total engineering units	Desired alphanumeric title	
	Rate	Second, Minute, Hour, Day or Million/Day	
	Scaling factor	1, 10, 100, 1000, 10,000, 100,000 or 1E6	
	Resettable	Yes or No	
TOTAL 2	SAME AS TOTAL 1 -- except for input 2		
Controller			
CONTROL 1 (2)	PID tuning sets	1 or 2	
	Set point source	Local, remote, or 2 local	
	Ratio (input 2)	-20.00 to 20.00	0.01
	Bias	-999 to 9999	1
	SP tracking	None or RSP	
	Power-up mode recall	Manual, Auto LSP, or Auto RSP	
	High and low SP limits	0 to 100% of span in engineering units	
	Action	Direct or reverse	
	High and low output limits	-5 to 105% of output	1
	Dropoff value	-5 to 105% of output	1
	Deadband	-5.0 to 25	
	Output Hyst	0.0 to 5.0	
	Failsafe output value	Within the output limits	1
	Remote Switching	None, ToMan, ToLSP, To2SP, ToDir, RN/HLD	
	Man Key	Disable or Enable	
	PB or Gain	Proportional Band (%) or gain	1
	Reset units	Repeats/minute or minutes/repeat	
Control 1 Algorithm	PIDA, PIDB, PD + MR, 3PSTEP, ON-OFF		
Output 1 Algorithm	Current, Positn, TimeD, Cur TI, TI Cur, Time		
* Shed Mode	To Manual, Failsafe or Last		
* Shed SP	To LSP or To CSP		
OPTIONS	Input 1 (2,3,4)	Disable or Enable	
	Control 1 (2)	Disable or Enable	
	Reject Frequency	60 or 50 HZ	
	Relative Humidity	Yes or No	
	Atm. Pressure	590 to 800	
	Deviation	None, SetPnt, Chan 1	
	*COM State	Disable or Enable	
	*COM Address	0 to 99	
	*SHED Time	0 to 255	
	Units	Eng or Percent	

Specifications (continued)

Controller (continued)

GROUP	PARAMETERS	SETTING RANGE OR SELECTION	RESOLUTION
ALARMS (soft, indication only)	SP Value SP Type Alarm Type Alarm Hysteresis	0.0 to 9999 None, Input 1 (2,3,4), RH, Dev, Output, Dev2, Out2, Shed, EV1 ON, EV1 OFF, EV2 ON, EV2 OFF High or Low 0.0 to 5.0 % of span	0.1
LOCKOUT	Password Lockout Change	Up to four characters None, Calib, + Conf, + View, Max Used if changing Password	
STATUS	Version Failsafe RAM Test ConfigurationTest CalibrationTest * Comm Test Fact Crc (Factory Set Input Constants)	Latest Software Version Yes or No Pass or Fail Pass or Fail Pass or Fail Pass or Fail Pass or Fail	

Controller Output ¹
(Optional)

- *On-Off or Time Proportional*
One SPST electromechanical relay. Control action can be set for direct or reverse; N.O. or N.C. contact selectable.
- *On-Off Duplex, 3 position Step, or Time Proportional Duplex*
Two SPST electromechanical relays. Control action can be set for direct or reverse; N.O. or N.C. contact selectable.
- *Current Proportional*
21 mAdc maximum into a negative or positive grounded or non-grounded load of 0 to 1000 ohms. Output range can be set between 4 and 20 mA, and as direct or reverse action.
Resolution: 10 bits
Accuracy: 0.5% full scale
- *Position Proportional*
Two SPST electromechanical relays operate motor having a 100 ohm to 1000 ohm slidewire.
- *Current/Time Duplex and Time / Current Duplex*
Variation of time proportional duplex for Heat/Cool applications. Time proportional output (heat or cool) is a SPST electromechanical relay. Current proportional output (heat or cool) is a 4-20 mA signal that can be fed into a negative or positive grounded load of 0 to 1000 ohms and is operational over 50% of range or the entire range.
Time Proportional Relay Resolution: 4.4 mSec.
Relay Contact Ratings:
Resistive Load: 5A @ 120 Vac, 2.5A @ 240 Vac
Inductive Load: 50 VA @ 120 Vac or 240 Vac
Cycle Time: 1 to 120 seconds
Current Proportional:
Resolution: 10 bits
Accuracy: 0.5% full scale

Case	Molded, foamed-Noryl™ with gasketed door to meet NEMA 3 enclosure requirements. Stainless Steel NEMA 4X door available as an option.
Chart	12-inch (304.8mm) diameter chart. Plain thermal-sensitive paper.
Wiring Connections	Terminals inside the case.
Color	Case: Black Door (standard): Caribbean blue
Approval Bodies	U.L. approval depending on model. Consult Model Selection Guide for information. FM approved for Class I, Div 2, Groups A, B, C, D areas.

*Communications only

™Registered Trademark -- General Electric Co.

1. Not all controller outputs are available on all models of the Truline Recorder. Consult Model Selection Guide for information.

Specifications (continued)

Dimensions	See Figure 3
Weight	13.2 lbs (6 kg)
Mounting	Panel or surface mounted. Some kits available for existing panel cutouts.
Options	
Alarm Output	Two SPST electromechanical relays on DR450T & DR450W Two, four or six relays available on DR450R <i>Relay Contact Ratings:</i> First two relays, Resistive Load:1A @ 120 Vac, 1/2A @ 240 Vac. Relays 3 through 6, Resistive Load:5A @ 120 Vac, 2.5A @ 240Vac.
Digital Input	+ 20 Vdc source for external dry contact or isolated solid state contacts. Selects one configured input.
Totalizers	One or two totalizers on DR450T and DR450R Models. Up to four totalizers on DR450W Model. Eight digit "totals" with multiplier on digital display; 14-digit totalization printout on chart.
Calculations	F ₀ calculation available on DR 450R Model. Open channel flow calculations available on DR 450W Model.
Miscellaneous	<ul style="list-style-type: none"> ● NEMA 4X Stainless Steel door with glass or acrylic window ● Door Lock ● Chart Illumination ● U.L. Listing ● Control ● Plastic Window ● Customer ID Tag ● Pulse output counter alarm function on DR450W Model ● Lead seal provisions on DR450H Model with FDA compliance
DMCS Communications	<i>Baud Rate:</i> 19,200 <i>Protocol:</i> DMCS <i>Length of Link:</i> 4000 ft (1,219 m) maximum <i>Link Characteristics:</i> Two wire, multidrop

Specifications (continued)

Environmental and Operating Conditions

Parameter	Reference	Rated	Extreme	Transport and Storage
Ambient Temperature	67 to 77°F 19 to 25°C	58 to 131°F 15 to 55°C	32 to 131°F 0 to 55°C	-40 to 151°F -40 to 66°C
Relative Humidity (%RH)	0 to 55*	10 to 90*	5 to 90*	5 to 95*
Vibration				
Frequency (Hz)	0	0 to 70	0 to 200	0 to 200
Acceleration (g)	0	0.1	0.2	0.5
Mechanical Shock				
Acceleration (g)	0	1	5	20
Duration (ms)	0	30	30	30
Mounting Position from Vertical				
Tilted Forward	5°	5°	5°	Any
Tilted Backward	5°	30°	90°	Any
Tilted to Side (±)	5°	10°	20°	Any
Power Requirements				
Voltage (VRMS)	119 to 121 238 to 242	102 to 132 204 to 264	102 to 132 204 to 264	N/A N/A
Frequency (Hz)	49.8 to 50.2 59.8 to 60.2	49 to 51 59 to 61	48 to 52 58 to 62	N/A N/A
Power Consumption	24 watts maximum			

General Reference Data

Stray Rejection	<i>Common Mode Rejection Ratio:</i> 120dB or 1 LSB (whichever is greater) at 60 Hz with maximum source impedance of 100 ohms. <i>Normal Mode Rejection Ratio:</i> 60dB with 100% span peak to peak maximum at 60 Hz.
Static Charge Effects	Exposed panel surfaces capable of withstanding a discharge from a 250pf capacitor charged to 10KV through 100 ohms.
RFI Susceptibility	Capable of withstanding an EMI-field generated from a 5-watt transmitter being held at 1 meter, and operating at 151.685 and 450 MHz.
Line Noise Effects	Field terminals for connecting power line to recorder can withstand the IEEE Surge Withstanding Capability Test to a level of 2.5KV.
Stylus Life	Typically capable of printing one chart per day for five years under clean room conditions.
Warranty and Technical Assistance	DR 4500 carries a 2-year warranty, and toll-free 800 number puts technical assistance only a phone call away.

Dimensions: $\frac{\text{millimeters}}{\text{inches}}$

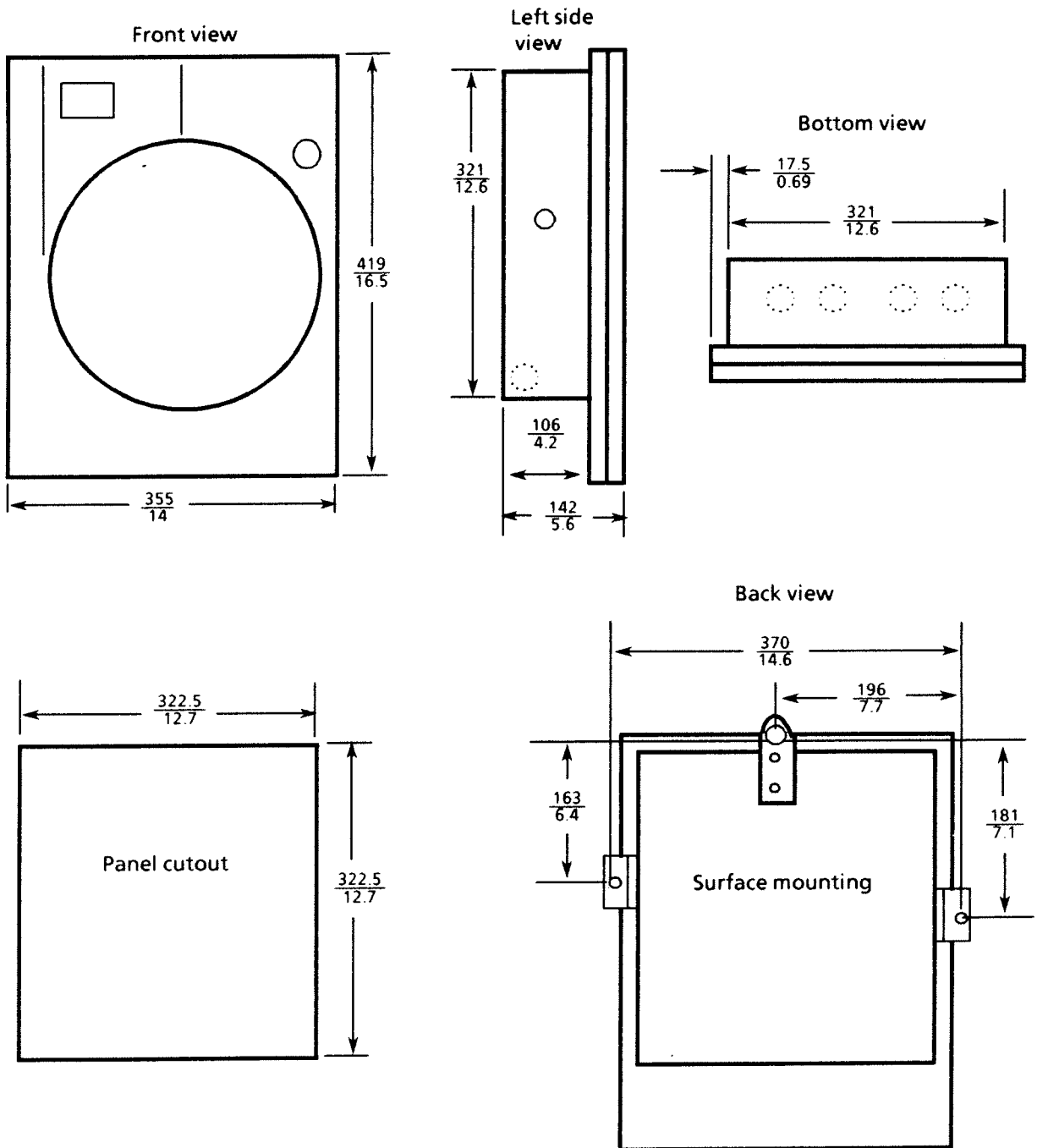

Figure 3 -- DR 4500 series recorder dimensions -- for reference only

Ordering Information

For complete ordering information, request Model Selection Guide 44-45-16-05 for DR 4500 Series Circular Chart Recorder.

Honeywell offers a full line of sensors and transmitters that produce a compatible range of dc voltage or current signals which can be used as inputs to the DR 4500 Series Recorder. These devices measure:

Temperature (Thermocouple or RTD)

Pressure

Flow { 4 to 20 mA dc or 1 to 5 Vdc process transmitter

Liquid Level

Relative Humidity

For more information, contact your nearest Honeywell Branch Office or

Honeywell Inc.
1100 Virginia Dr.
Fort Washington, PA 19034

In Canada,

Honeywell Limited
155 Gordon Baker Road
Willowdale, Ontario M2H 3N7

Specifications are subject to change without notice.

INDEX

A

- A-1 4-8 – 4-9
 A-2 4-9 – 4-10
 A1S1 4-6, PW-4, 5-11 – 5-12, 12-4, 12-48
 A1S1TYPE 5-12, 12-48
 A1S2 4-6, PW-4, 5-11 – 5-12, 12-4, 12-48
 A1S2TYPE 5-12
 A2S1 4-6, PW-4, 5-11 – 5-12, 12-4, 12-48
 A2S1TYPE 5-12
 A2S2 4-6, PW-4, 5-11 – 5-12, 12-4, 12-48
 A2S2TYPE 5-12
 A3S1 12-4, 12-48
 A3S2 12-4, 12-48
 A4S1 12-4 – 12-5, 12-48
 A4S2 12-4 – 12-5, 12-48
 A5S1 12-5, 12-48
 A5S2 12-5, 12-48
 A6S1 12-5, 12-48
 A6S2 12-5, 12-48
 abort 4-11, 4-16, 4-31, 4-35, 4-41, 4-46, 4-53, 4-57, 4-70, 4-78, 4-87, 5-10, 12-6, 12-10, 12-38
 abrasion 5-16
 abrasive 5-15
 AC 1, 3, 5
 access 3-9 – 3-10, 4-87, 6-16, 7-8, 12-3
 accessed 9-1
 accessories 3-3 – 3-4, 3-6 – 3-7
 accessory 4, 8-4
 accordance 9-2
 accumulating 12-7
 activate 4-34, 4-74, 12-7
 activates 4-86, 12-14, 12-19, 12-23, 12-28, 12-32, 12-37
 activation 4-34
 activity 6-5
 actuates 7-7 – 7-8
 actuating 7-6
 actuation 1-2, 4-48 – 4-49, 4-70 – 4-72, 6-1, 7-3, 12-38, 12-40 – 12-41, 12-43 – 12-44, 12-46
 actuations 1-2
 adapter 5-16
 adaption 2-2
 adaptors 8-2
 ADDR 4-6
 adequacy 2
 adjustable 9-8 – 9-10
 adjustment 2-5
 adjusts 9-2
 air-conditioning 3
 AL 4-6
 AL1 PW-4, 5-12, 12-4, 12-48
 AL2 PW-4, 5-12, 12-4, 12-48
 AL3 12-4, 12-48
 AL4 12-5, 12-48
 AL5 12-5, 12-48
 AL6 12-5, 12-48
 ALARM1 12-38, 12-40 – 12-41, 12-43 – 12-44, 12-46
 ALARM2 12-38, 12-40 – 12-41, 12-43 – 12-44, 12-46
 ALARM3 12-38, 12-40 – 12-41, 12-43 – 12-44, 12-46
 ALARM4 12-38, 12-40 – 12-41, 12-43 – 12-44, 12-46
 ALARM5 12-38, 12-40 – 12-41, 12-43 – 12-44, 12-46
 ALARM6 12-38, 12-40 – 12-41, 12-43 – 12-44, 12-46
 alarms 4-1, 4-6, 4-9, 4-78 – 4-86, PW-4, 5-11 – 5-12, 7-8, 12-4, 12-10 – 12-18, 12-48, 12-19 – 12-37
 alcohol 5-15 – 5-16
 ALG PW-3, 7-6 – 7-7
 algorithm 4-12 – 4-14, 4-57, 4-67 – 4-68, 4-74, 7-6 – 7-7, 9-2 – 9-3, 9-5, 9-8 – 9-11, 10-2
 algorithms 7-1
 align 2-4
 aligned 2-5
 alignment 5-16, 6-16 – 6-17
 ALIGNMNT 6-16
 ALM 4-7 – 4-10, 5-3
 ALOGRTHM 4-14
 Alpha 6-3
 alphanumeric 4-33, 4-45, 4-47, 4-54, 4-87, 12-39 – 12-40, 12-42 – 12-43, 12-45 – 12-46
 ALSP 4-60
 alternately 4-10, 5-6, 5-8 – 5-9
 ambient 6-3, 6-12
 amperes 6
 amplitude 10-1 – 10-3
 amps 6
 analog 1, 3, 7-3
 angled 1
 AnSnVAL 7-8
 appendix 1-1, 1-4 – 1-5, 3-11, 4-2, 4-6, 4-11, 4-16, 4-57 – 4-68, 4-75, 4-78, PW-1 – 5-2, 9-1, 9-4, 10-1, 11-1, 12-1
 applicable 1-2 – 1-3, 3-2 – 3-3, 3-5 – 3-10, 4-1, 4-10, 4-13, 4-15, 4-50, 4-67 – 4-68, 4-80 – 4-82, 4-84 – 4-86, 5-4, 5-9, 6-4 – 6-6, 6-11 – 6-13, 6-15, 7-7 – 7-8, 7-10, 8-3, 9-2, 9-8, 9-10, 10-2, 12-7, 12-9, 12-12 – 12-14, 12-17 – 12-18, 12-21 – 12-23, 12-26 – 12-27, 12-30 – 12-32, 12-35 – 12-36
 AR100 2-2
 ARSP 4-60
 ATM 4-6, 12-4
 atmosphere 5-15
 ATMPRES PW-4
 attaches 7-9
 attaching 2-5, 7-9

- attachment 7-5
- attenuate 3
- AUTO-MAN 5-14
- Autotune 4-88
- B**
- Badger 2-2
- bargraph 4-9, 5-4
- bayonet-type 5-16
- BD 4-11, 4-14, 4-66
- bias 4-5, 4-59, PW-3, 5-7, 7-4, 9-6
- Bladed 6-2
- blinks 4-11, 4-17, 4-32, 4-36 – 4-37, 4-42, 4-44, 4-50 – 4-51, 4-59, 4-61, 4-74 – 4-75, 4-78, 7-1, 12-10
- brackets 2-2 – 2-3, 2-5
- Bristol 2-2
- Brown-Outs 7-4
- BTC 4-49
- bumpless 4-69
- bundled 2
- Burned-Out 5-16
- burnout 4-4, 4-52, PW-2, 7-2, 9-8
- bypassing 3-1
- C**
- C-1 2-2 – 2-3
- C-2 2-2, 2-4
- C-J 6-12
- cabinets 4
- cabling 7-4 – 8-5
- CAL 4-6, 6-11, 7-2 – 7-3
- calculation 1-2, 4-6, 4-42, 4-74 – 4-75, 12-1, 12-6 – 12-9, 12-48
- CALIB 4-6, 4-88, 6-11, 6-14 – 6-16
- calibrate 3-2, 3-4 – 3-5, 3-7, 3-9, 6-2, 6-5, 6-11 – 6-13, 6-15, 7-3
- calibrated 5-1, 6-1, 6-12 – 6-13, 7-3
- calibrating 6-2 – 6-6, 6-11 – 6-14
- calibration 3-2, 3-4 – 3-5, 3-7, 3-9, 4-6, 4-10, 4-88, 6-1 – 6-2, 6-4 – 6-16, 7-2 – 7-4, 7-6 – 7-7, 7-10
- calibrator 6-2, 6-6, 6-10 – 6-13
- CALTEST 7-2
- capability 1-3
- capacitive 1 – 2
- capacitor 4, 6, 7-9
- capacitors 6
- capscrew 7-8 – 7-9
- Celsius 5-3
- CHAN1 4-75
- characterization 4-48, 4-50
- characterize 4-48
- CHART1HI 4-3, 4-44, PW-1
- CHART1LO 4-3, 4-44, PW-1
- CHART2HI PW-1
- CHART2LO PW-1
- CHART3HI PW-1
- CHART3LO PW-1
- CHART4HI PW-2
- CHART4LO PW-2
- charts 5-1, 5-16
- checksum 7-3
- CHN 4-7 – 4-10, 5-2 – 5-6, 5-8 – 5-11
- CHNge 5-2, 5-12
- CHNGE 5-8
- CHNGes 5-10
- CHNGing 5-8 – 5-9
- CHRT 4-2, PW-1
- CHT 5-16, 7-8
- CL 1-2
- CL-XXXX 1-3
- clamp-type 6-6
- clamps 3-1 – 3-12, 12-3
- Classic 8-6
- clears 7-2
- closure 4-42, 4-65, 5-6, 5-13, 12-9, 12-48
- codes 2
- cold-junction 7-4
- Com 4-6
- ComADDR PW-4
- COMMTEST 4-6
- Compensate 4-51
- compensation 4-51, 4-74
- computed 9-10
- computes 12-7
- ComSTATE 4-6, PW-4
- Condensor 6
- conductor 8-4
- conduit 3-1 – 2, 6-6
- conduits 2-1, 1 – 2
- CONF 4-6, 4-88
- configurable 5-11, 9-1, 12-7
- configuration 4-1, 4-9 – 4-88, 5-1, 5-8 – 5-12, 6-1, 6-11, 6-16, 7-3 – 7-8, 7-10, 9-1, 9-11, 11-1, 11-3, 12-1, 12-6 – 12-18, 12-38 – 12-47, 12-19 – 12-37
- configure 1-1, 4-86, 4-88, 9-4 – 9-5, 9-10, 11-1, 12-6, 12-14, 12-19, 12-23, 12-28, 12-32, 12-37
- configured 1-3, 3-11, 4-42, 4-48 – 4-49, 5-1 – 5-2, 5-5 – 5-6, 5-8 – 5-13, 5-16, 6-1, 6-11 – 6-12, 6-16, 7-2 – 7-3, 7-5 – 7-7, 9-4 – 9-5, 9-7 – 9-9, 10-2, 11-1, 12-7
- configuring 4-1, 4-7 – 4-88, 6-1
- conformance 7-4
- CONFTEST 7-2 – 7-3
- connections 1-2, 2-1, 3-9 – 3-10, 6-14 – 6-15, 7-4 – 7-5, 12-3
- connector 3-1 – 3-10, 3-12, 6-2, 6-4, 6-6, 6-13, 7-4 – 7-7, 7-9 – 7-10, 8-3, 8-6, 9-6, 12-3
- connectors 3-4, 3-7, 3-9, 3-11, 6-4, 6-15, 7-10
- constants 6-1, 6-12, 7-3, 9-2 – 9-3, 9-5, 10-1 – 10-2, 10-5
- CONT-ALG 9-9 – 9-10
- CONT1ALG 4-5, 4-12, PW-3, 9-9

- CONT2 PW-3
 CONT2ALG 9-9
 contactors 1-2, 4
 contacts 3-11, 4, 6, 5-11, 5-13, 9-10-9-11
 continuity 7-5
 CONTROL 4-57-4-59, 4-62
 CONTROL2 4-57
 controller 3-8-4-9, 4-29, 4-60, 4-63, 4-65-4-66, 4-69, 4-78-4-86, 5-2, 5-4-5-5, 5-8-5-11, 5-13, 6-1, 6-13, 6-15, 7-2, 7-6-7-7, 9-1-9-2, 9-4-9-10, 10-1, 10-4-10-5, 11-1, 12-9-12-36
 controller's 9-2, 9-8-9-9, 10-1, 10-3
 controllers 1-3, 5-2, 5-5, 5-8-5-11, 9-6-9-7, 9-9-9-10
 conversion 7-3
 copper 3-2, 3-5, 6-2, 6-6
 corrective 7-2, 9-2, 9-9
 cotton 5-15-5-16
 counterclockwise 5-16
 coupling 1-2
 CRC 4-6, 7-2-7-3
 crimp 3-12
 criteria 7-3
 crossover 2
 CSP 4-69
 CUR 4-68, 7-7
 CUR-TI 9-11
 CURRNT 4-68, 9-10
 cutout 2-1-2-4, 7-10
 Cutouts 2-2
 CYC 4-2, 4-15, PW-1
 CYC-SEC 9-3
 CYC2 4-2
 CYC2-SEC 9-3
 CYC2SEC PW-1
 CYCLE2 10-5
 cycled 7-1
D
 D-1 12-6
 D-2 12-7-12-9
 D-3 12-10-12-37
 D-4 12-38-12-47
 D1-1 12-1-12-2
 D4-1 12-4-12-5
 dc 3, 6-7, 6-3
 de-energize 9-8
 deactivate 4-74, 4-86, 12-7, 12-14, 12-19, 12-23, 12-28, 12-32, 12-37
 deadband 4-5, 4-64, PW-3, 9-5, 9-8-9-11, 10-2
 decode 1-1, 1-3
 decoded 4-1
 Decoding 1-1-1-5
 decreasing 5-10
 DECREMENT 5-14
 default 4-87-4-88, 6-16
 defective 4-9, 7-1
 Deg 4-20, 4-22-4-23, 4-25-4-26, 4-28, 4-30, 4-47
 Derivative 9-9, 10-1
 designate 11-1
 designates 11-2
 detection 5-3
 detects 5-13
 DEV 4-2, 4-10, 4-79-4-80, 4-83-4-84, 5-5, 11-4-11-5, 12-11-12-12, 12-16, 12-20-12-21, 12-25, 12-29-12-30, 12-34
 deviation 4-6, 4-9-4-10, 4-20, 4-75, 4-79-4-80, 4-83-4-84, PW-4, 5-4-5-5, 9-2, 10-1, 11-1-11-2, 11-4-11-5, 12-4, 12-8, 12-11-12-12, 12-16, 12-20-12-21, 12-25, 12-29-12-30, 12-34
 DEVSET 4-6, 12-4
 DEVSETPT PW-4
 DGTL 4-43-4-44
 DGTL1 4-42, 5-6
 DGTL2 4-42, 5-6
 diagnostic 4-7, 5-3, 5-7, 7-2
 dictate 5-1
 digital 1-1-1-5, 3-11, 1-4, 4-42-4-44, 5-6, 5-11, 5-13, 7-3, 7-8, 8-4, 12-1-12-3, 12-9
 diode 6-7
 DIR 4-65, 5-13, 12-9
 DISABL 4-2, 4-16, 4-18, 4-30, 4-41, 4-54, 4-70-4-73, 4-76, 6-11, 6-15, 9-4, 11-3
 disable 4-16, 4-18, 4-41, 4-54, 4-66, 4-70-4-73, 4-76, 5-8, 5-10, 9-4
 disabled 4-18, 4-30, 4-53, 5-3, 11-3
 Disables 9-4
 disabling 5-10
 disconnect 6-4, 6-13, 7-4, 7-9-7-10
 disconnected 6-15
 Disconnecting 6-4
 discreet 6
 DISP 4-8-4-11, 4-15-4-17, 4-30-4-31, 4-34-4-35, 4-40-4-41, 4-45-4-46, 4-52-4-53, 4-56-4-57, 4-69-4-70, 4-77-4-78, 4-86-4-88, 5-2, 5-4-5-6, 5-8, 5-10-5-12, 5-14, 5-16, 6-11, 6-13-6-14, 6-16-6-17, 7-2, 9-5-12-6, 12-9-12-10, 12-38, 12-47, 12-37
 Display 5-8, 5-12
 Displaying 5-6
 dissipated 6
 dissipation 6
 DIV 4-2-4-3, PW-1
 divider 8-3
 DMCS 3-12, 4-69, 4-76-4-77, 8-4
 DR450R 1-1-1-2, 4-13, 4-15
 DR450T 1-2
 dropoff 4-5, 4-63, PW-3, 5-8, 9-8
 dt 12-7
 Dual 7-7

duplex 3-10, 4-13 – 4-15, 4-57, 4-64,
4-68, 7-7, 9-2 – 9-3, 9-5, 9-9 – 9-11,
10-1 – 10-2, 10-5

dust-resistant 5-16

E

E1 4-53

EE 5-7

Electrocube 6

electrostatic 1

eliminates 9-2

EMI 1

energization 1

energize 9-8

Eng 4-4, 4-10, 4-77, PW-2

Engr 11-4 – 11-5

Ensuring 7-10

equivalents 6-2 – 6-3

ER 2-2

ERR 5-3

erroneous 1

establishes 9-6

ETCH 4-49

ETCL 4-49

EU 4-5, 4-10, 4-47, 4-53, PW-2 – PW-3,
5-5

EV 4-6, PW-4, 12-4 – 12-5, 12-48

EV1 4-78 – 4-80, 4-83 – 4-84,
12-10 – 12-12, 12-15 – 12-16,
12-19 – 12-21, 12-24 – 12-25,
12-28 – 12-30, 12-33 – 12-34

EV2 4-79 – 4-80, 4-82 – 4-84

EVNT 4-6, 12-5, 12-48, 12-38

exciters 1

exits 4-8, 5-14

expotential 4-53

EXT 4-34

extension 3-2, 3-5, 6-2, 6-6,
9-9 – 9-10

EXTSW1 12-38, 12-40 – 12-41,
12-43 – 12-44, 12-46

EXTSW2 12-38, 12-40 – 12-41,
12-43 – 12-44, 12-46

F

facilitate 7-10

Factory-set 7-3

failsafe 4-5 – 4-6, 4-29, 4-52, 4-65,
4-69, PW-3, 5-2, 5-7 – 5-8, 7-2, 9-8, 11-3

failures 5-7, 7-3

feedback 3-9, 6-15 – 6-16, 9-10

ferro-resonant 3

filler 2-1 – 2-3, 8-3

FILTER1 4-4

filtering 2

filters 2 – 3

FINAL-SP 9-4

fine-tuning 10-4

finger 7-9

Fischer 2-2

flat-faced 2-1

flat-head 2-5

Fo 4-2, 4-6, 12-4, 12-6, 12-9, 12-48,
12-48

form 9-10

format 4-36

Foxboro 2-2

FREQ 4-6, PW-4, 12-4

FRIDAY 4-38

FSAFE 4-69

FUNC 4-2 – 4-6, 4-8 – 4-48,
4-50 – 4-88, 5-9, 5-11 – 5-12, 5-14,
6-11 – 6-12, 6-14 – 6-17, 7-2, 9-1,
12-4 – 12-18, 12-38 – 12-47,
12-19 – 12-37

G

GAIN2 10-5

gasket 8-1, 8-6

generating 3

GIN 10-3

GPM 4-53

grid 2, 6-17

grounding 1

guarantees 11-1 – 11-2

guidelines 1

H

H2O 4-47

halts 11-2

header 4-2, 4-34, PW-1, 5-16

hex 2-2, 2-5

HG 1-2

Hierarchy 4-1 – 4-6, 12-4 – 12-5

highlighted 4-33, 4-45, 4-47, 4-54,
12-39 – 12-40, 12-42 – 12-43,
12-45 – 12-46

highlighting 4-33, 4-45, 4-47, 4-54,
12-39 – 12-40, 12-42 – 12-43,
12-45 – 12-46

HILIM 4-5, PW-3, 5-9, 9-7

HL 4-6, PW-4, 12-4 – 12-5, 12-48

HLD 4-65, 5-13

HP 1-2

HR 4-3 – 11-4

hrs 4-20 – 4-30, 11-1 – 11-2, 11-4

hubs 8-2

HYST 4-5 – 4-6, PW-3 – PW-4, 5-12,
9-8, 9-10 – 9-11, 12-4 – 12-5, 12-48

hysteresis 4-64, 4-86, 5-12, 9-5,
9-8 – 9-10, 12-14, 12-19, 12-23, 12-28,
12-32, 12-37

I

ID 1-2

identifier 4-33, 4-47, 4-54

identify 12-48

IEC 6-3

IEEE 2

- illumination 1-2 – 1-3
- immaterial 10-3
- immunity 2
- impair 2
- impedance 1, 7-6
- imply 11-1
- IN1 4-4, PW-2, 6-1, 6-11 – 6-12
- IN1TYPE 4-49
- IN2 PW-2, 6-1, 7-4
- IN2TYPE 4-49
- IN3 PW-2, 6-1
- IN3TYPE 4-49
- IN4 PW-2, 6-1, 6-11 – 6-12
- IN4TYPE 4-49
- incorporate 1
- INCREMENT 5-14
- increments 4-45
- indications 4-7 – 5-9, 5-14
- indicator 5-2 – 5-6, 5-8 – 5-11, 5-13, 7-7
- indicators 4-7 – 4-8, 5-1, 5-3 – 5-4, 5-14, 7-6 – 7-7
- inductive 1 – 2, 4 – 7
- infrequent 5-1
- initially 5-1
- Initiate 5-8
- initiated 4-65, 7-1, 12-9
- initiates 3-11, 4-42
- INP1FAIL 5-7, 7-3
- INP1RNG 5-7
- INP2FAIL 5-7, 7-3
- INP2RNG 5-7
- INP3FAIL 5-7, 7-3
- INP3RNG 5-7
- INP4FAIL 5-7, 7-3
- INP4RNG 5-7
- INPTCOMP 4-4, PW-2
- INPUT1 12-7
- INPUT2 12-7
- INPUT3 12-7
- INPUT4 12-7
- inputs 1-1 – 1-2, 1-5, 3-2 – 3-7, 3-11, 4-1, 4-43 – 4-44, 4-74, 5-1, 6-1 – 6-8, 6-10 – 6-12, 12-2 – 12-3, 12-7
- inserting 2-3
- inserts 2-4
- installation 1 – 2, 5-13, 6-1, 7-1, 7-4 – 7-8
- installations 3
- installer 2
- installing 5-1, 5-16
- instantaneous 5-3
- instrumentation 1
- insufficient 2
- insulated 2, 6-2
- integration 4-55, 5-7, 7-3
- integrity 5-7
- interact 10-1
- interaction 5-1
- interchange 3-2 – 3-7
- interface 1-2 – 3, 4-1, 5-1
- interfering 2
- internally 5-3
- interruption 4-60
- interrupts 6
- isolate 7-2
- J**
- J1 3-8, 3-12 – 6-13, 7-6 – 7-7
- J10 3-3, 3-6
- J2 3-2 – 3-7, 3-9, 6-4, 6-6, 6-12, 6-15, 7-6, 7-10, 9-6
- J3 3-11, 7-10
- J4 3-11, 7-5, 7-9
- J5 3-9 – 3-10, 6-15, 12-3
- J6 3-2 – 3-7, 6-4, 6-6, 6-12
- J7 7-9
- J8 7-9
- J9 3-1, 7-4
- Joules 5
- JTCH 4-49
- JTCL 4-49
- jumpers 3-9 – 3-11, 6-5, 7-10, 12-3
- junction 6-3, 6-6, 6-12
- K**
- Kent 2-2, 2-4
- keyboard 5-13, 7-5, 7-10, 9-5 – 9-6
- keypad 4-11, 4-16; 4-31, 4-35, 4-41, 4-46, 4-53, 4-57, 4-66, 4-70, 4-78, 4-87 – 4-88, 5-1, 5-9, 12-6, 12-10, 12-38
- keystroke 1-1
- knockout 2-1 – 3-8, 3-10 – 3-12, 12-3
- knockouts 2-1, 3-9, 12-3
- KTCH 4-49
- KTCL 4-49
- L**
- L1 3-1, 12-14
- L2 3-1, 12-19
- L3 3-1, 12-23
- L4 12-28
- L5 12-32
- L6 12-37
- LASTSP 4-29
- latch 8-1, 8-6
- leadwire 7-4
- leadwires 7-4 – 7-5
- left-most 9-4
- lethality 12-7
- lg 8-6
- LI 4-62
- lifter 5-15 – 5-16, 7-9 – 7-10, 8-6
- limiters 4
- LN 6-17

LO 4-4, 4-80 – 4-81, 4-84 – 4-85, PW-2, 5-9, 12-12 – 12-13, 12-17 – 12-18, 12-21 – 12-22, 12-26 – 12-27, 12-30 – 12-31, 12-35 – 12-36

Lo-Hi 4-34

local-key 9-6

lockout 4-1, 4-6, 4-11, 4-16, 4-31, 4-35, 4-41, 4-46, 4-53, 4-57, 4-70, 4-78, 4-87 – 4-88, PW-4, 6-1, 6-11, 6-16, 12-6, 12-10, 12-48, 12-38

lockwasher 2-2

lockwashers 2-5

LOLIM 4-5, PW-3, 5-9, 9-7 – 9-8

low-level 3-1

lower-left 7-10

LOWR 4-8 – 4-11, 4-15 – 4-17, 4-30 – 4-31, 4-34 – 4-35, 4-40 – 4-41, 4-45 – 4-46, 4-52 – 4-53, 4-56 – 4-57, 4-69 – 4-70, 4-77 – 4-78, 4-86 – 4-88, 5-2, 5-4 – 5-6, 5-8, 5-10 – 5-12, 5-14, 5-16, 6-11, 6-13 – 6-14, 6-16 – 6-17, 7-2, 9-5 – 12-6, 12-9 – 12-10, 12-38, 12-47, 12-37

LSP 4-29, 4-65, 4-69, 5-13, 9-7, 12-9

LWR 5-14

M

mA 1-2, 3-2 – 3-3, 3-5 – 3-6, 3-8, 3, 4-48 – 4-49, 6-3, 6-13, 6-15, 7-6 – 7-7, 9-10, 12-1 – 12-3

maintenance 5-1, 5-16, 7-9

MAJORDIV PW-1 – PW-2

malfunction 5-3, 5-7

malfunctions 5-3

MANual 5-5

manually 5-2, 5-8, 6-15, 7-6 – 7-7

MAX 4-88, 5-6, 6-11, 6-16

Maximizing 5-15

mfd 5

Micro 2-2

microfarad 4, 6

microfarads 6

microvolts 6-1

milliammeter 6-13 – 6-14, 7-6 – 7-7

milliampere 6-10

milliamperes 6-2 – 6-3, 6-6, 6-10, 6-13

millimeters 2-2, 2-5

millivolt 6-6, 6-11 – 6-12

millivolts 3, 6-2 – 6-3, 6-8

min 4-2 – 4-3, 4-5, 4-12, 4-14 – 4-15, 4-20 – 4-30, 4-67, PW-1, PW-3, 9-8, 11-1 – 11-2, 11-4

Minimal 10-1

minimize 1, 5-15 – 5-16, 10-2

MINORDIV 4-3, PW-1 – PW-2

MINorRPM 9-2, 9-8

miscellaneous 8-1 – 8-3, 8-6

misinterpreted 1

mmHg 4-74

mo 4-34

Momentarily 5-11

momentary 5-13

MONDAY 4-38

monitor 5-2 – 5-3, 5-6, 7-1

monitored 5-3

Monitoring 5-1, 5-3, 5-6

mother 1-4 – 1-5, 7-10, 12-1 – 12-2

motor's 3-9

MOV 4 – 6

MOVs 4

MR 4-13, 4-67, 9-2, 9-10

MSG 4-6, 12-5, 12-48, 12-38

MTR 6-15

mV 1-2 – 1-3, 3-2, 3-4 – 3-5, 3-7, 4-48 – 4-49, 6-3, 6-11 – 6-12

N

N-H 4-8

NAM 4-2, PW-1

nameplate 7-1, 8-1

NC 9-10 – 9-11

networks 1, 6

NIC-TC 4-49

Nicrosil-Nisil 4-49, 6-3

NiNiMoly 6-3

NNMTC 4-49

noise-free 1

noise-generating 1

nominal 9-8

non-linear 4-48

non-volatile 1-2, 5-7, 6-1, 7-3

nos 4-34

O

O-M 4-8

O-ring 8-6

OD 4-69

ohm 3-3 – 3-4, 3-6 – 3-7, 4, 4-49, 4-74, 6-2, 9-10

ohms 3-3, 3-6, 3-8 – 3-9, 5 – 6, 6-1 – 6-3, 7-6, 9-10

on-control 5-4

ON-OFF 4-64, 4-67, 9-8 – 9-9

One-pen 1-4

operational 4-1

optimum 7-1, 8-1

option 4-76, 5-13

options 1-2, 1-4 – 1-5, 4-1, 4-6, 4-42, 4-46, 4-57, 4-70 – 4-77, PW-4, 5-13, 8-3 – 8-4, 12-1 – 12-2, 12-4, 12-6 – 12-9, 12-48, 12-28

opto-isolators 2

ordering 8-1

orientation 7-8, 7-10

oscillate 10-2

oscillates 10-2

oscillation 10-1, 10-3

oscillations 10-2

OUT-ALG 9-10 – 9-11

out-of-range 5-7

- OUT1 PW-3
- OUT1ALG 4-5, 9-10
- OUT2 PW-3
- OUT2ALG 9-10
- OUTHILIM 5-8, 9-8
- outlets 3
- OUTLOLIM 5-8, 9-8
- OUTPT1 4-42
- OUTPT2 4-42
- outputs 1-1 – 1-2, 3-11, 6-1, 6-13, 12-1 – 12-3
- overbraid 2
- overranging 7-3
- overshoot 10-1
- overwrites 6-1

- P**
- P1 4-34
- P2 4-34
- P3 4-34
- P4 4-34
- panel 1-1, 2-1 – 2-5, 8-3
- parameter 4-1, 4-9 – 4-48, 4-50 – 4-88, 5-3, 5-5, 5-8 – 5-9, 5-12, 5-16, 7-3, 9-1 – 9-11, 10-1, 12-6 – 12-18, 12-38 – 12-48, 12-19 – 12-37
- parameters 4-1, 4-9 – 4-10, 4-57, 5-5, 5-8 – 5-9, 5-12, 9-1 – 9-3, 9-5 – 9-11, 10-1 – 10-3, 10-5
- Partlow 2-2
- password 4-6, 4-87 – 4-88, 12-48
- PB 4-2, 4-5, 4-11, 4-66, PW-1, PW-3, 5-2, 9-2, 9-8, 10-1 – 10-4
- PBorGAIN 9-2, 9-8
- PCB 1-4 – 1-5, 3-1 – 3-12, 5-6, 6-1, 6-13, 6-15, 7-1 – 7-10, 8-1 – 8-4, 9-6, 12-1 – 12-3
- PCBs 3-5 – 3-7, 8-4
- PCT 4-66, 9-8, 9-11
- PD 4-13, 4-67, 9-2, 9-10
- PEN1 PW-1
- PEN2 PW-1
- PEN2IN 4-74
- PEN3 PW-1
- PEN3IN PW-1
- PEN4 PW-2
- PERCNT 4-77
- periodic 5-16, 6-1
- Periodically 5-15
- pertinent 9-1, 9-3, 12-1
- PI 10-3
- PID 4-5, 4-14 – 4-15, 4-57, 4-67, PW-3, 5-8, 5-11, 9-3, 9-5, 9-8 – 9-9, 10-3, 10-5
- PID-A 4-12, 4-14, 9-2 – 9-3, 9-9
- PID-B 4-12, 4-14, 9-2 – 9-3, 9-9
- PIDSET1 5-11
- PIDSET2 5-11
- PIDSETS 5-11
- PIDSETX 4-10, 5-5
- plug-in 3-9 – 3-10, 12-3
- plugs 2-1 – 3-7, 3-9, 3-11, 6-2, 6-15, 7-10
- pm 7-1
- polarity 3-2 – 3-8, 6-4, 6-13
- POS 6-15
- positioned 6-15
- positioning 9-10 – 9-11
- POSITN 4-68, 7-6, 9-10
- POSITON 12-48
- POSITON1 12-5
- POSITON2 12-5
- POSITON3 12-5
- POSITON4 12-5
- POSITON5 12-5
- POSITON6 12-5
- power-down 9-8
- Power-Up 7-1
- power-up 4-60, 5-2, 7-1 – 7-3, 9-5, 9-7
- powered-up 4-34
- pre-determined 9-2
- precaution 1
- preferably 2
- Prerequisites 3-2 – 3-12, 4-11, 4-16, 4-31, 4-35, 4-41, 4-46, 4-53, 4-57, 4-70, 4-78, 4-87, 12-3, 12-6, 12-10, 12-38
- PRES 4-6, 12-4
- prevention 3-1 – 2
- printed-circuit 8-1
- printhead 1-4
- printout 12-41 – 12-42, 12-44 – 12-45, 12-47
- priority 5-13
- proceeding 5-1
- proficient 10-1
- profile 4-18 – 4-29, 5-10, 11-1, 11-3 – 11-4
- prog 1-2, 4-2, 4-79 – 4-86, PW-1, 11-4 – 11-5, 12-11 – 12-14, 12-16 – 12-18, 12-20 – 12-23, 12-25 – 12-27, 12-29 – 12-32, 12-34 – 12-36
- programming 1-2 – 1-3, 5-9 – 5-10, 11-1
- progs 1-2
- prompted 12-6
- prompts 1-1, 4-1 – 4-6, 4-10 – 4-11, 4-16, 4-31, 4-35, 4-41, 4-46, 4-53, 4-57, 4-70, 4-75, 4-78, 4-87, 5-5, 7-1 – 7-4, 9-1 – 9-2, 9-6, 9-10 – 9-11, 10-5, 12-4 – 12-6, 12-8, 12-10, 12-38, 12-48
- PROP-BD 9-2
- PROP-BD2 9-3
- proportional-only 10-1
- Propotional 7-6
- protrude 2-5
- proven 2
- PT 4-6, 4-49, 12-4
- purge 5-15 – 5-16
- PV 4-9 – 4-10, 4-46 – 4-47, 4-58, 4-64, 5-2 – 5-11, 6-3, 6-5, 7-2, 7-4, 7-7, 9-2, 9-4 – 9-5, 9-8 – 9-9, 10-2 – 10-4, 11-1
- PV-SP 9-9

PVLIMIT 5-7

PW 1-2

R

RA 4-10, 4-22 – 4-23, 4-25, 5-5, 5-10

ramp 4-1 – 4-2, 4-10, 4-16 – 4-30,
4-65, 4-88, PW-1 – 5-3, 5-5, 5-8 – 5-11,
5-13, 9-1, 9-4, 11-1, 11-3 – 11-5, 12-9

Ramp's 4-17

RAMP1 4-2, 4-16 – 4-18

RAMP2 4-2, 4-16 – 4-17

ramps 4-2, 4-20, 4-22 – 4-23,
4-25 – 4-26, 4-28, 11-1

RAMPUNIT 11-4 – 11-5

RAMPXXXM 5-10

randomly 5-1

RATE-MIN 9-2

RATE2 10-5

RATE2MIN 4-2, PW-1, 9-3

RC 4, 6

Read-Only 4-88

read-only 4-50

real-time 4-35 – 4-36

recalculate 7-3

recalibrate 6-1, 7-3 – 7-4, 7-6 – 7-7,
7-10

recalibrated 9-10

recalibration 6-1

receptacles 3-4, 3-7

Reconfigure 7-10

reconfiguring 1-2, 7-8

Reconnect 6-13, 7-10

recorder's 1-1 – 1-5, 4-1, 4-66, 5-1,
5-3, 6-10, 7-1 – 7-2, 8-1recorders 4-13, 4-15, 5-2, 5-5,
5-8 – 5-11, 6-1

Rectifiers 1

recurring 7-2

RECYC 4-10, 5-5, 5-10

recycle 4-19, 11-2

recycles 4-2, 4-10, 4-19, 5-5,
11-4 – 11-5

reenter 7-3

Ref 4-1

regularly-scheduled 6-1

reinstall 3-9 – 3-10, 6-6, 6-13, 12-3

REJ 4-6, PW-4, 12-4

rejection 2 – 3, 4-73

REL 4-42

relevant 4-1, 11-1

RELHUMID 4-6, PW-4, 12-4

reluctance 2

REM 4-2, 4-5, PW-1, PW-3, 5-13, 12-4,
12-6, 12-9, 12-48

reposition 3-2, 3-5, 3-11

reseat 7-5

reset 4-2, 4-12 – 4-13, 4-15, 4-53,
4-56, 4-67, 5-2, 5-8, 5-12, 7-2, 7-5,
9-2 – 9-3, 9-5, 9-8 – 9-10, 10-1 – 10-5,
12-4, 12-6, 12-9, 12-48, 12-48

RESET2 10-5

Resets 12-48

resettable 4-56, 5-12

Resetting 5-12

resistance-capacitance 4

resistor 3-3, 3-6, 4 – 6, 6-1 – 6-3,
6-5 – 6-7, 6-11 – 6-13, 8-3

resistors 3-4, 3-7, 6

resolution 3, 6-2

responds 5-13, 9-2, 10-1

Restart 9-7

restores 4-10, 6-1

Restoring 6-1

resume 5-16

retainer 8-6

retaining 5-16, 8-1, 8-6

REV 4-2, PW-1, 12-9

reverts 6-15

REVRSE 4-62, 9-8

rewiring 1-2

RFI 1

RG1782-3 6

RH 4-10, 4-42, 4-74, 4-79 – 4-80,
4-83 – 4-84, 5-5, 5-15, 6-3,
12-11 – 12-12, 12-16, 12-20 – 12-21,
12-25, 12-29 – 12-30, 12-34

ripple 5-15

RN 4-65, 5-13

RNG 4-5, PW-3, 9-11

RNG1TAG 4-3, PW-1

RNG2TAG PW-1

RNG3TAG PW-1

RNG4TAG PW-2

routed 2

RSET 4-2, 4-15, PW-1, 5-12, 9-2, 9-10

RSET-MIN 9-2

RSET-RPM 9-2

RSET2 PW-1

RSET2MIN 4-2 – 9-3

RSETABLE 4-5, 4-53, PW-2 – PW-3

RSP 4-7 – 4-10, 4-60, 5-3, 5-5, 5-9,
5-13, 9-7

RST 12-6, 12-9, 12-48

RST2RPM 9-3

RTC 4-49

RTD 1-2 – 1-3, 3-2, 3-4 – 3-5, 3-7, 3,
4-49 – 4-50, 4-74, 6-1 – 6-3, 6-5 – 6-6,
6-8

RTDs 6-1

rule-of-thumb 6

RUN-HOLD 5-14

RV 5-7, 7-4

RVLIMIT 5-7

S

SATDAY 4-38

scaler 4-5, 4-53, 4-55, PW-2 – PW-3

screwdriver 6-2

SCRs 1

SEC 4-2, 4-15, PW-1

- Seg 4-2, 11-4 – 11-5
- SEG1 11-4
- SEG10 11-4
- SEG11 11-4
- SEG12 11-4
- SEG1RAMP 4-2, 11-4 – 11-5
- SEG2 4-2, 11-4 – 11-5
- SEG2TIME 4-2, 11-4 – 11-5
- SEG3 11-4
- SEG3RAMP 11-4 – 11-5
- SEG4 11-4 – 11-5
- SEG4TIME 11-4 – 11-5
- SEG5 11-4
- SEG5RAMP 11-4 – 11-5
- SEG6 11-4 – 11-5
- SEG6TIME 11-4 – 11-5
- SEG7 11-4
- SEG7RAMP 11-4 – 11-5
- SEG8 11-4 – 11-5
- SEG8TIME 11-4 – 11-5
- SEG9 11-4
- SEG9RAMP 11-4 – 11-5
- segements 4-30
- selectable 4-9, 9-5
- selects 4-10, 5-13, 9-8
- self-diagnostic 7-1
- Self-Diagnostics 7-1
- sensor 4-51 – 4-52, 6-2 – 6-3, 6-5 – 6-6, 6-11 – 6-12, 7-2, 7-4 – 7-5
- sequenced 4-1
- sequential 4-7
- sequentially 1-2, 4-10, 5-2, 5-4 – 5-5, 5-8
- serial 7-1, 8-1
- servicing 6-1
- servo 7-4 – 7-5, 7-9, 8-2
- Servoline 8-3
- Set-Up 1-1
- set-up 1-1 – 9-11
- SETPNT 4-75
- SETPT1 4-42
- SETPT2 4-42
- setup 6-3, 6-6 – 6-10, 6-13
- Setups 6-5
- SG10 11-4 – 11-5
- SG10TIME 11-4 – 11-5
- SG11RAMP 11-4 – 11-5
- SG12 11-4 – 11-5
- SG12TIME 11-4 – 11-5
- SHEDMODE PW-3
- SHEDTIME 4-6, PW-4
- shielded 3-12, 3
- shielding 2
- SHLD 3-12
- Silicon 1
- SIMPLEX 9-10
- simulate 7-2
- SK 4-10, 5-5, 5-10
- slack 3-1
- slidewire 3-9, 6-15 – 6-16, 7-6, 9-10
- slotted 6-4, 6-13, 7-8 – 7-9
- soaks 4-2, 11-2
- software 1-1 – 1-3, 4-1, 7-1 – 7-2
- solenoid 5
- Solenoids 1
- SP 1-2, 4-1 – 4-2, 4-5, 4-10, 4-16 – 4-30, 4-58 – 4-59, 4-78 – 4-86, PW-1, PW-3, 5-2, 5-4 – 5-5, 5-8 – 5-11, 5-13, 7-7, 9-4 – 9-7, 9-9, 11-3 – 11-5, 12-10 – 12-36
- SP-PV 9-2
- SP-RAMP 9-4
- SP2 5-9
- Spacer 8-4
- SPD 4-2, PW-1
- spec 6-15
- Specifications 6-1
- specifies 4-38
- specify 4-1, 8-1
- SPs 5-8 – 5-9
- SPST 9-10 – 9-11
- SQROOT 4-49
- stalled 5-1
- start-up 5-1
- starters 1, 4
- Startup 6-10
- STC 4-49
- STD 12-4, 12-48
- steady-state 6
- STERIL 12-11 – 12-12, 12-16, 12-20 – 12-21, 12-25, 12-29 – 12-30, 12-34
- STERILIZ 12-4, 12-6, 12-48
- sterilization 12-6 – 12-9, 12-11 – 12-12, 12-16, 12-48, 12-20 – 12-21, 12-25, 12-29 – 12-30, 12-34
- straightforward 4-1, 5-1, 7-1
- stranded 2
- STRT 4-2, 11-4 – 11-5
- stylus 1-4, 7-9
- successively 4-11, 4-16, 4-31, 4-35, 4-41, 4-46, 4-53, 4-57, 4-70, 4-78, 4-87, 12-6, 12-10, 12-38
- summarized 6-1
- summarizes 5-13
- SUNDAY 4-38
- Supplier 5
- suppress 2
- suppressed 4
- suppression 3-1 – 2, 4 – 7
- suppressors 2, 4
- SW 4-5, 4-57, PW-1, PW-3, 5-13, 9-5, 12-4, 12-6, 12-9, 12-48
- SW1 4-34
- SW2 4-34, 12-4, 12-6
- swab 5-15 – 5-16

switchover 4-58, 9-5
 SYMPTOM 7-4 – 7-6, 7-8
 system's 1

T

Tb 12-7
 TEMP 6-12, 12-4, 12-48
 templates 2-5
 termination 4-29, 11-3
 TEST1 4-34
 TEST2 4-34
 TEST3 4-34
 TEST4 4-34
 thermocouple 1-3, 3-2, 3-4 – 3-5,
 3-7, 3, 4-49, 6-1 – 6-3, 6-5 – 6-7,
 6-11 – 6-13, 7-4
 thermocouples 6-1, 6-3
 THRDAY 4-38
 three-mode 9-9
 Thyristor 1
 TI 4-68, 7-7
 TI-CUR 9-11
 TIME-D 4-68
 TIME-MIN 9-4
 timer 11-1 – 11-2
 toggled 9-6
 tolerance 6-1
 tolerate 5-1
 TOT 4-5, 5-12
 totalization 1-2 – 1-3, 4-1, 4-
 53 – 4-55, 5-6
 totalized 4-56, 5-6, 5-12
 totalizer 4-53, 5-6, 5-8, 5-12
 totalizers 5-6
 TP 4-13
 tracking 4-60, 9-7
 transfers 9-7
 transformer 3 – 4, 7-4, 8-3
 transient 3 – 5

transmissions 1
 transmitters 3-3, 3-6, 2
 triggered 7-8, 12-39, 12-41 – 12-42,
 12-44 – 12-45, 12-47
 trip-point 7-8
 troubleshoot 7-1
 troubleshooting 4-7, 5-2, 5-7,
 7-1 – 7-2
 TRULIN 4-34
 Truline 8-1 – 8-2, 12-1
 Ts 12-7
 TTCH 4-49
 TTCL 4-49
 TUE DAY 4-38
 TUN 9-5
 TUNING2 4-67
 two-wire 3-2, 3-5
 TWO-YEAR 7-1

U

unacceptable 4-11, 4-17, 4-32,
 4-36 – 4-37, 4-42, 4-44, 4-50 – 4-51,
 4-59, 4-61, 4-74 – 4-75, 4-78, 12-10
 underranging 7-3
 Unguaranteed 11-2
 uniformity 1
 unitless 9-8
 unplug 7-10
 unpredictable 1
 Unscrew 5-16
 unwired 3-1 – 3-12, 12-3
 upsets 5-1
 user-supplied 2-5

V

V130LA10A 5
 V275LA15A 5
 Vac 3-1, 1, 4, 6

VAL 4-6, PW-4, 5-11, 6-14, 6-16,
 12-4 – 12-5, 12-48
 varistor 5
 varistors 4
 Vdc 1-2, 3-2 – 3-7, 3, 6, 4-49, 6-1, 6-5,
 8-3
 verify 1-1, 4-8, 5-1, 5-7, 5-14, 7-1,
 7-4 – 7-5, 7-7, 10-4
 versa 5-11
 versus 1-4 – 1-5, 11-1, 12-1 – 12-2
 Visually 7-5
 Volt 3-2, 3-5
 voltage 3-1, 1, 3 – 6, 4-73, 6-2 – 6-3,
 6-11 – 6-12, 7-4, 7-6
 voltmeter 7-6
 volts 6-2 – 6-3, 6-6, 6-8 – 6-9

W

W1 3-2 – 3-7, 3-11, 6-5 – 6-6, 6-13
 W2 3-2 – 3-7, 3-9 – 3-11, 6-5 – 6-6,
 12-3
 W3 3-9 – 3-11, 12-3
 W4 3-9 – 3-11, 12-3
 W5 3-9 – 3-10, 12-3
 W5W26 6-3
 warm-up 6-13, 6-15
 WARRANTY 7-1
 Watt 5
 WEDDAY 4-38
 windings 3
 wired 3-1 – 3-12, 4-1, 5-6, 5-13, 6-4,
 12-3
 wiring 1-1, 1-3, 2-1, 3-1 – 3-12, 1 – 4,
 6-4 – 6-5, 6-13, 6-15, 7-2, 7-4, 7-6 – 7-8,
 12-1, 12-3
 worksheet 4-1, 12-48
 worksurface 2-1, 2-3
 WTCH 4-49
 WTCL 4-49

X

X1 1-5, 4-68
X100 1-5, 12-2
X111 3-5
X11X 3-5
X1XX 3-5
X200 1-5, 12-2
X222 3-6
X22X 3-6
X2XX 3-6
X300 1-5, 12-2
X333 3-7
X33X 3-7
X3XX 3-7
X4 1-5, 4-16, 4-68
XHR 4-31 – 4-32
Xmitter 4-4, 4-49 – 4-50, PW-2
Xmtr 3-3, 3-6
XX 4-46, 11-1 – 11-2
XX1 1-4 – 1-5, 3-11, 4-78
XX10 1-5, 12-2
XX20 1-5, 12-2
XX30 1-5, 12-2
XXX 4-46, 5-12, 11-1
XXX1 1-5, 12-2
XXX2 1-5, 12-2
XXX3 1-5, 12-2
XXXX 1-2, 4-46, 4-87
XXXXX 4-47
XXXXXX 6-12

Y

yr 4-34
YY 11-1 – 11-2

Honeywell

Industrial Automation and Control
Honeywell Inc.
1100 Virginia Drive
Fort Washington, Pennsylvania 19034

Helping You Control Your World