

# ECONOMY VACUUM OVENS



110 – 120 Volts    220 – 240 Volts



## Installation - Operation Manual

SVAC1E    SVAC2E / SVAC1E-2    SVAC2E-2

Pictured on cover left to right:

SVAC1E, SVAC2E

The SVAC1E and SVAC2E ovens require a 110 – 120-volt NEMA 5-15R power outlet.

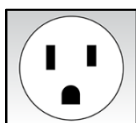

The SVAC1E-2 and SVAC2E-2 require a CEE7 220 – 240-volt power outlet compatible with CEE7/7 cords to plug in to.

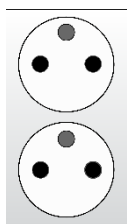

**Warning:** This product contains chemicals, including triglycidyl isocyanurate, known to the State of California to cause cancer as well as birth defects or other reproductive harm. For more information, go to [www.P65Warnings.ca.gov](http://www.P65Warnings.ca.gov).



**¡Advertencia!** Este producto contiene sustancias químicas, incluido el triglicidil isocianurato, que el estado de California sabe que causa cáncer, así como defectos de nacimiento u otros daños reproductivos. Para obtener más información, visite [www.P65Warnings.ca.gov](http://www.P65Warnings.ca.gov).

**Avertissement!** Ce produit peut vous exposer à des produits chimiques, dont l'isocyanurate de triglycidyle, reconnu par l'État de Californie pour provoquer le cancer, des anomalies congénitales ou d'autres problèmes de reproduction. Pour plus d'informations, visitez le site [www.P65Warnings.ca.gov](http://www.P65Warnings.ca.gov).

# Economy Vacuum Ovens

110 – 120 Voltage — SVAC1E SVAC2E

220 – 240 Voltage — SVAC1E-2 SVAC2E-2

Part Number (Manual): 4861658

Revision: November 22, 2021

*ISO CERTIFIED MANUFACTURER*



SHEL LAB is a brand of Sheldon Manufacturing, INC, an ISO 9001 certified manufacturer.

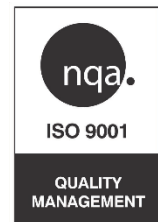

These units are vacuum ovens intended for professional, industrial, or educational use where the preparation or testing of materials is done at an ambient air pressure range of 22.14 – 31.3 inHg (75 – 106 kPa), and no flammable, volatile or combustible materials are being heated.

These models are compliant with the following standards:

CAN/CSA C22.2 No. 61010-1:2012

CAN/CSA C22.2 No. 61010-2-010/R:2009

UL 61010-1:2012

UL 61010A-2-010:2002

EN 61010-1:2010

EN 61010-2-010:2003

# TABLE OF CONTENTS

<b>INTRODUCTION .....</b>	<b>5</b>
<i>Read this Manual.....</i>	5
<i>Safety Considerations and Requirements .....</i>	5
<i>Contacting Assistance .....</i>	6
<i>Manufacturing Warranty .....</i>	6
<i>Engineering Improvements.....</i>	6
<i>Vacuum Supply Required .....</i>	7
<i>Gaskets .....</i>	8
<b>RECEIVING YOUR UNIT .....</b>	<b>9</b>
<i>Inspect the Shipment.....</i>	9
<i>Orientation Images .....</i>	10
<i>Record the Data Plate Information.....</i>	13
<b>INSTALLATION .....</b>	<b>15</b>
<i>Installation Procedure Checklist .....</i>	15
<i>Required Ambient Conditions.....</i>	16
<i>Required Clearances.....</i>	16
<i>Power Source Requirements .....</i>	17
<i>Lifting and Handling .....</i>	18
<i>Leveling.....</i>	18
<i>Install the Oven .....</i>	19
<i>Deionized and Distilled Water.....</i>	19
<i>Installation - Clean and Disinfect.....</i>	19
<i>Shelving Installation.....</i>	20
<i>Connect to the Vacuum Supply .....</i>	21
<b>GRAPHIC SYMBOLS .....</b>	<b>23</b>
<b>CONTROL OVERVIEW .....</b>	<b>25</b>
<b>OPERATION.....</b>	<b>27</b>
<i>Operating Precautions.....</i>	27
<i>Theory of Operation .....</i>	28
<i>Put the Oven into Operation .....</i>	30
<i>Evacuating the Oven Chamber.....</i>	32
<i>Select Approximate Oven Temperature.....</i>	33
<i>Temperature Matching.....</i>	34
<i>Maximum Obtainable Vacuum.....</i>	36
<i>Pressure Units Conversion Chart.....</i>	36
<b>USER MAINTENANCE.....</b>	<b>37</b>
<i>Cleaning and Disinfecting.....</i>	37
<i>Maintaining Atmospheric Integrity .....</i>	38
<i>Electrical Components .....</i>	38
<i>Vacuum Pump Maintenance.....</i>	38
<i>Storage.....</i>	38
<b>UNIT SPECIFICATIONS .....</b>	<b>39</b>
<i>Weight.....</i>	39
<i>Dimensions.....</i>	39
<i>Capacity .....</i>	40
<i>Shelf Capacity by Weight.....</i>	40
<i>Vacuum .....</i>	40
<i>Temperature .....</i>	41
<i>Power .....</i>	41
<b>PARTS LIST.....</b>	<b>43</b>
<i>Replacement Gaskets.....</i>	44

# INTRODUCTION

*Thank you for purchasing a SHEL LAB oven. We know you have many choices in today's competitive marketplace when it comes to constant temperature equipment. We appreciate you choosing ours. We stand behind our products and will be here if you need us.*

## ***READ THIS MANUAL***

Failure to follow the guidelines and instructions in this user manual may create a protection impairment by disabling or interfering with the unit safety features. This can result in injury or death.

Before using the unit, read the manual in its entirety to understand how to install, operate, and maintain the unit in a safe manner. Keep this manual available for use by all operators. Ensure all operators are given appropriate training before the unit begins service.

## ***SAFETY CONSIDERATIONS AND REQUIREMENTS***

Follow basic safety precautions, including all national laws, regulations, and local ordinances in your area regarding the use of this unit. If you have any questions about local requirements, please contact the appropriate agencies.

**SOPs:** Because of the range of potential applications this unit can be used for, the operator or their supervisors must draw up a site-specific standard operating procedure (SOP) covering each application and associated safety guidelines. This SOP must be written and available to all operators in a language they understand.

**Intended Applications and Locations:** SVAC economy ovens are engineered for constant temperature drying, curing, and baking applications under vacuum in professional, industrial, and educational environments. The ovens are not intended for use at hazardous or household locations.

**Power:** Your unit and its recommended accessories are designed and tested to meet strict safety requirements.

- The unit is designed to connect to a power source using the specific power cord type shipped with the unit.
- Always plug the unit power cord into a protective earth grounded electrical outlet conforming to national and local electrical codes. If the unit is not grounded properly, parts such as knobs and controls can conduct electricity and cause serious injury.
- Do not bend the power cord excessively, step on it, or place heavy objects on it.
- A damaged cord can be a shock or fire hazard. Never use a power cord if it is damaged or altered in any way.
- Use only approved accessories. Do not modify system components. Any alterations or modifications to your unit not explicitly authorized by the manufacturer can be dangerous and will void your warranty.

# INTRODUCTION

## ***CONTACTING ASSISTANCE***

Phone hours for Customer Support are 6 am – 4:30 pm Pacific Coast Time (west coast of the United States, UTC -8), Monday – Friday. Please have the following information ready when calling or emailing Customer Support: the **model number, serial number, and part number** (see page 13).

support@sheldonmfg.com  
1-800-322-4897 extension 4  
(503) 640-3000 extension 4  
FAX: (503) 640-1366

Sheldon Manufacturing, INC.  
P.O. Box 627  
Cornelius, OR 97113  
USA

## ***MANUFACTURING WARRANTY***

For information on your warranty and online warranty registration please visit:

- [sheldonmanufacturing.com/warranty](http://sheldonmanufacturing.com/warranty)

## ***ENGINEERING IMPROVEMENTS***

Sheldon Manufacturing continually improves all of its products. As a result, engineering changes and improvements are made from time to time. Therefore, some changes, modifications, and improvements may not be covered in this manual. If your unit's operating characteristics or appearance differs from those described in this manual, please contact your SHEL LAB dealer or customer service representative for assistance.

# INTRODUCTION

## VACUUM SUPPLY REQUIRED

The oven does not come with a vacuum pump. **A pump must be separately purchased for the oven.**

Consult a vacuum pump specialist to determine the pump type best suited to your baking application. The correct selection of a vacuum pump is critical for evacuating the chamber to the level required for your vacuum baking applications in a timely manner. The nature of the sample or product being heated should drive the selection of the pump, including the types of chemicals outgassed during the baking process. Common pump types include Chemical Duty PTFE Dry, Standard Duty Dry, Compact Direct-Drive, and specialty pumps for Corrosive gases. The selection of an application-specific pump can improve the overall oven performance and minimize pump maintenance costs.

Use of an oil trap plumbed on the vacuum line between the oven and the pump is strongly recommended. The trap protects the pump from any oils outgassed during your baking procedure. This extends the life of the pump. All maintenance and instructional information should be obtained from the pump manufacturer if not shipped with the pump. Use of clamps to secure vacuum tubing is also recommended.

### Pumping Capacity

Ensure that the selected vacuum pump is rated to a minimum flow capacity of 5 cubic feet per minute (cfm) greater than the chamber volume.

Model	Chamber Capacity	Minimum Pump Capacity	Minimum Pump Capacity
SVAC1Es	0.56 CuFt	6 cfm	170 Liters per Minute
SVAC2Es	1.67 CuFt	7 cfm	198 Liters per Minute

### Minimum Vacuum Draw

To seal completely, the oven chamber must be under a minimum vacuum draw of:

inHg	mmHg
3.0	76

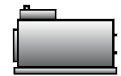

Or



**Building  
Vacuum Supply**

# INTRODUCTION

## ***GASKETS***

Gaskets are non-warranty, high-wear consumable items subject to compression forces, heat, and outgassed byproducts. Heavy usage rates may necessitate frequent replacements. The manufacturer strongly recommends keeping a spare gasket on hand during operation.

Each oven comes with a replaceable silicone gasket installed on the chamber liner. This gasket seals against the chamber door to maintain the vacuum integrity of the chamber. The gasket must be replaced periodically and is rated to 230°C. It is vulnerable to acids and solvents. The manufacturer also offers for sale *Viton*®, fluorosilicone, and Buna gaskets. See page 44 for information on gasket type suitability for baking applications.

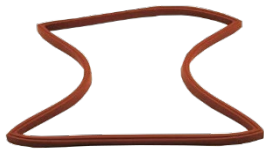



# RECEIVING YOUR UNIT

## ***INSPECT THE SHIPMENT***

- When a unit leaves the factory, safe delivery becomes the responsibility of the carrier.
- **Damage sustained during transit is not covered by the manufacturing defect warranty.**
- Save the shipping carton until you are certain that the unit and its accessories function properly.

When you receive your unit, inspect it for concealed loss or damage to its interior and exterior. If you find any damage to the unit, **follow the carrier's procedure for claiming damage or loss.**

1. Carefully inspect the shipping carton for damage.
2. Report any damage to the carrier service that delivered the unit.
3. If the carton is not damaged, open the carton and remove the contents.
4. The unit should come with an Installation and Operation Manual.
5. Verify that the correct number of accessories has been included.
6. Carefully check all packaging for loose accessories before discarding.

### **Included Accessories:**

**SVAC1Es**  
2 Shelves

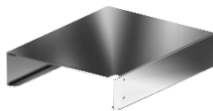

**SVAC2Es**  
2 Shelves

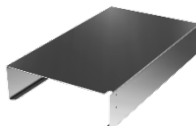

# RECEIVING YOUR UNIT

## ORIENTATION IMAGES

SVAC1Es

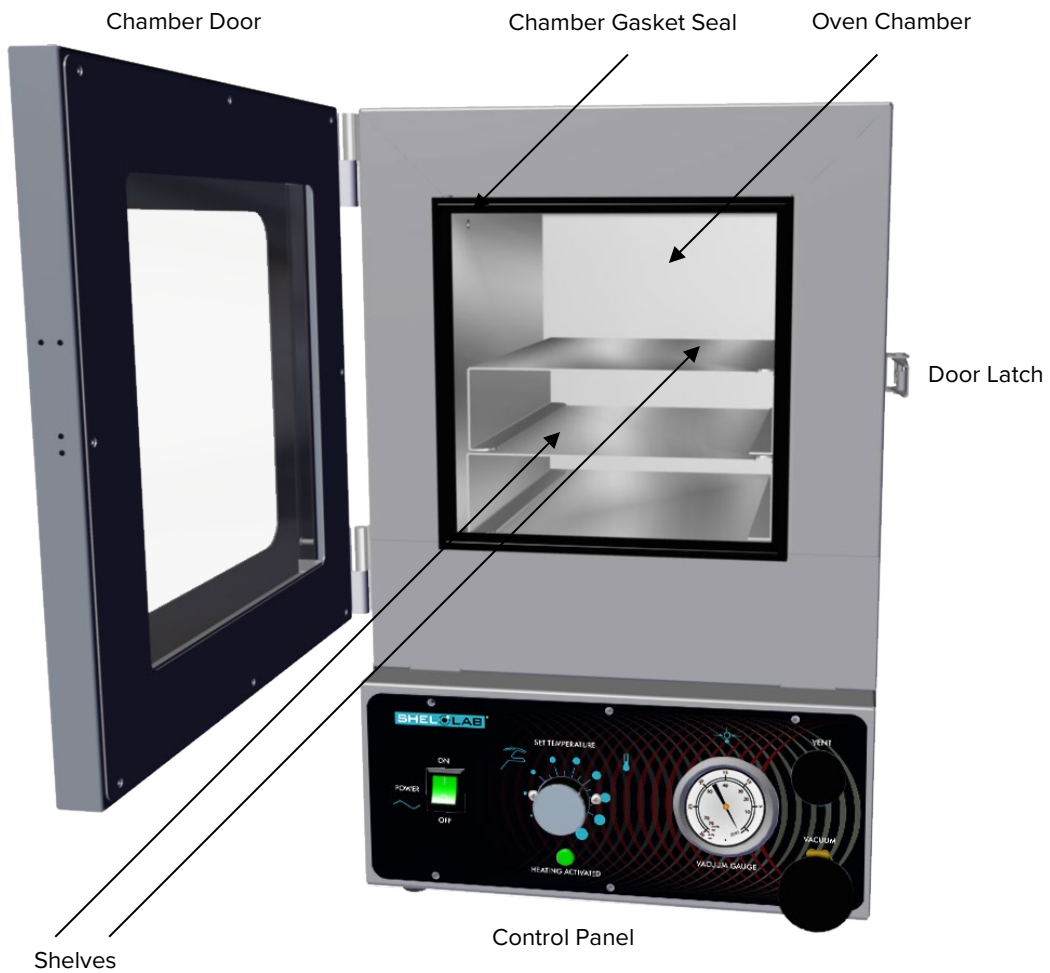

# RECEIVING YOUR UNIT

SVAC2Es



# RECEIVING YOUR UNIT

**Figure 1:** Unit Back

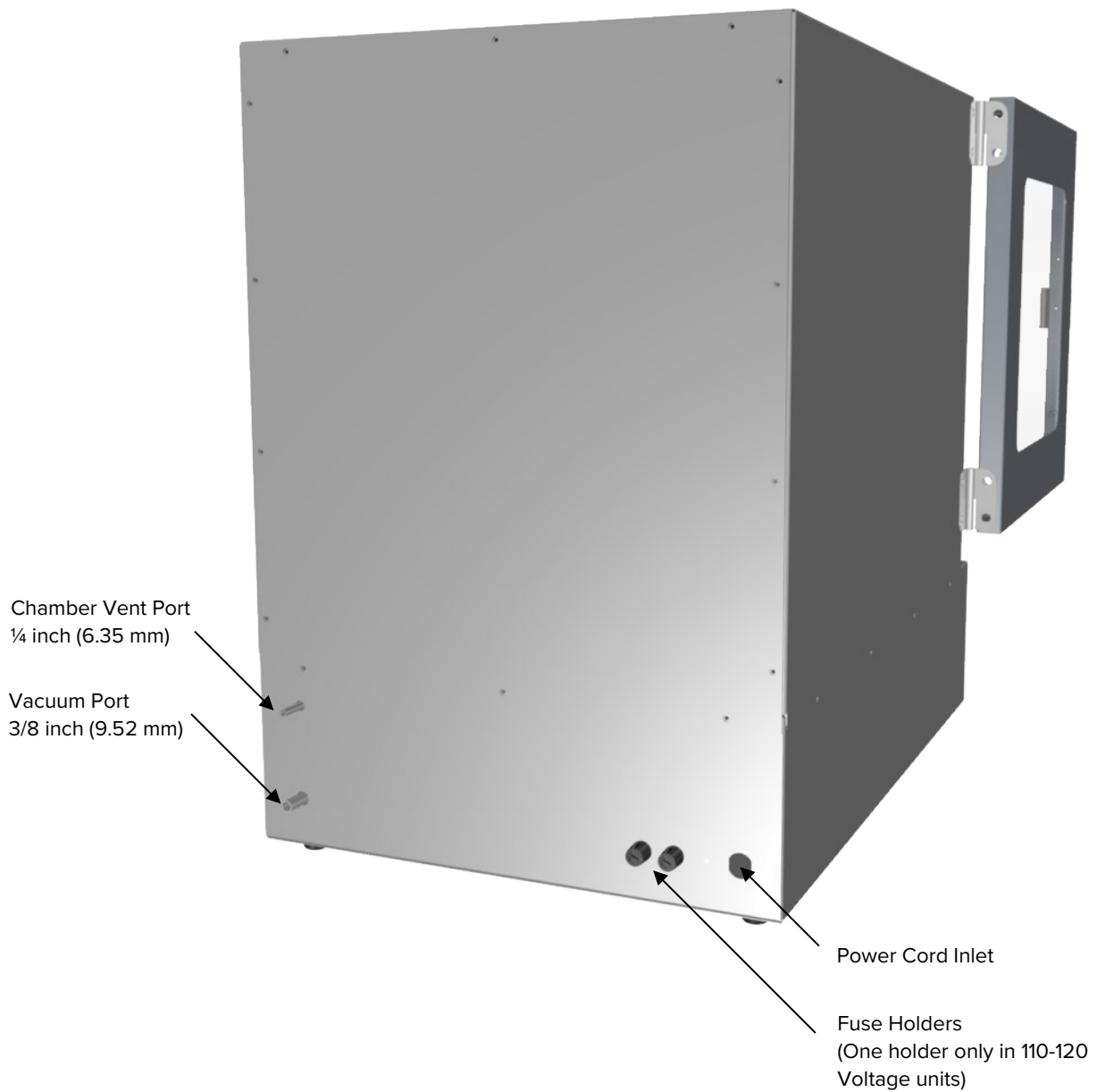

# RECEIVING YOUR UNIT

## *RECORD THE DATA PLATE INFORMATION*

The data plate contains the unit **model number**, **part number**, and **serial number**. Tech Support will need this information during any support call. Record it below for future reference.

- The data plate is located on the back of the oven above the power inlet.

<b>Model Number</b>	
<b>Serial Number</b>	
<b>Part Number</b>	



## *INSTALLATION PROCEDURE CHECKLIST*

Carry out the procedures and steps listed below to install the oven in a new workspace location and prepare it for use. All procedures are found in the Installation section of this manual.

### Pre-Installation

- ✓ Verify a vacuum supply source suitable for your application is available and can be connected to the oven.
  - See page 21 for the oven gas and vacuum port locations.
- ✓ Check that the required ambient conditions for the unit are met, page 16.
- ✓ Check that the spacing clearance requirements are met, page 16.
  - Unit dimensions may be found on page 39.
- ✓ Check that a suitable electrical outlet and power supply is present, page 17.

### Installing the oven in a suitable workspace location

- ✓ Review the lifting and handling instructions, page 18.
- ✓ Install the oven in its workspace location, page 19.
- ✓ Make sure the oven is level, page 18.

### Set up the oven for use

- ✓ Clean the oven shelving. Clean the chamber if needed, page 19.
- ✓ Install the shelving in the oven chamber, page 20.
- ✓ Connect the oven to its vacuum supply source, page 21.
- ✓ **Optional:** Connect the oven to an inert backfill gas. See page 21.

# INSTALLATION

## ***REQUIRED AMBIENT CONDITIONS***

When selecting a location to install the unit, consider all environmental conditions that can adversely impact its temperature performance. These include:

- Proximity to other ovens, autoclaves, and any device that produces significant radiant heat
- Heating and cooling vents or other sources of fast-moving air currents
- High-traffic areas
- Direct sunlight

This oven is intended for use indoors, at room temperatures between **15°C and 40°C (59°F and 104°F)**, at no greater than **80% Relative Humidity** (at 25°C / 77°F). Operating these units outside of these conditions may adversely affect temperature stability and effective operating range.

## ***REQUIRED CLEARANCES***

These clearances are required to provide airflows for ventilation and cooling.

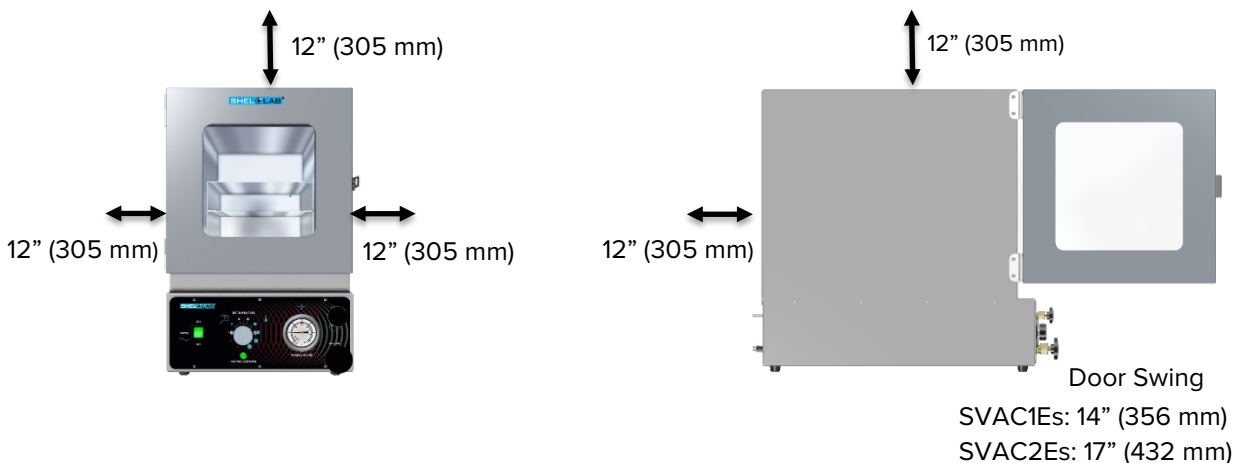

**12 inches (305 mm)** of clearance is required on the sides and back.

**12 inches (305 mm)** of headspace clearance between the top of the unit and any overhead partitions.

Do not place objects on top of the oven.



# INSTALLATION

## POWER SOURCE REQUIREMENTS

When selecting a location for the unit, verify each of the following requirements is satisfied.

**Power Source:** The wall power outlet must meet the power requirements listed on the unit data plate.

Model	AC Voltage	Amperage	Frequency
SVAC1E	110 – 120	5.0	50/60 Hz
SVAC2E	110 – 120	10.0	50/60 Hz
SVAC1E-2	220 – 240	2.5	50/60 Hz
SVAC2E-2	220 – 240	5.5	50/60 Hz

- Wall power sources must be protective earth grounded and **single phase**.
- Wall power sources must conform to all national and local electrical codes.
- **Supplied voltage must not vary more than 10% from the data plate rating.** Damage to the unit may result if the supplied voltage varies more than 10%.
- **The recommended wall circuit breakers for 110 – 120 VAC units are 15 amps.**
- **The recommended wall circuit breakers for 220 – 240 VAC units are 16 amps.**
- Use a separate circuit to prevent loss of product due to overloading or circuit failure. The circuit must match or exceed the amperage requirement listed on the unit data plate.

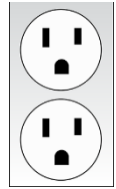

Standard NEMA 5-15R wall socket

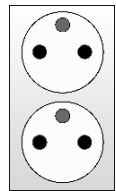

CEE7 Sockets compatible with CEE7/7 Plugs

**Power Cord:** The unit must be positioned so that all end-users can quickly unplug the oven in the event of an emergency.

- SVAC1E and SVAC2E units come provided with a 125-volt, 15 amp, 8ft 2 in (2.5m) NEMA 5-15P integrated power cord.
- SVAC1E-2 and SVAC2E-2 units come provided with a 250-volt, 16 amp 8ft 2 in (2.5m) CEE 16P integrated power cord.
- Always use this cord or an identical replacement.



**Fuses:** SVAC1Es and SVAC2Es each ship with a fuse installed in a fuse holder next to the power cord inlet. SVAC1E-2s and SVAC2E-2s each ship with 2 fuses installed in holders next to the cord inlet.

- Fuses must be installed and intact for the unit to operate.
- Always find and fix the cause of a blown fuse prior to putting the unit back into operation.
- Fuse types:
  - SVAC1Es: 250V, T6.3, 5X20mm
  - SVAC2Es: 250 V, T10A 5X20mm

# INSTALLATION

## ***LIFTING AND HANDLING***

The oven is heavy. Use appropriate lifting devices that are sufficiently rated for these loads. Follow these guidelines when lifting the oven:

- Lift the oven only from its bottom surface.
- Doors, handles, and knobs are not adequate for lifting or stabilization.
- Restrain the oven completely while lifting or transporting so it cannot tip.
- Remove all moving parts, such as shelves and trays, and lock doors in the closed position during transfers to prevent shifting and damage.

## ***LEVELING***

The oven is equipped with rubber feet to raise it off the counter and prevent sliding. Ensure that the oven is on a flat and level surface, prior to placing the unit in operation.



## ***INSTALL THE OVEN***

Place the unit in a workspace location that meets the criteria discussed in the previous entries of the Installation section.

## ***DEIONIZED AND DISTILLED WATER***

**Do not use deionized water** to clean the unit. The use of deionized water may corrode metal surfaces and voids the warranty. The manufacturer recommends the use of distilled water in the resistance range of 50K Ohm/cm to 1M Ohm/cm, or a conductivity range of 20.0 uS/cm to 1.0 uS/cm, for cleaning.

## ***INSTALLATION - CLEAN AND DISINFECT***

Cleaning and disinfecting the unit chamber and shelving components now reduces the risk of contamination. The chamber and shelving were cleaned and disinfected at the factory; however, the unit may have been exposed to contaminants during shipping.

- Remove all protective wrappings from shelving components prior to cleaning.
- See the [Cleaning and Disinfecting](#) entry on page 37 for information on how to clean and disinfect without damaging the unit or its components.

# INSTALLATION

## *SHELVING INSTALLATION*

SVAC economy ovens are provided with 2 identical stacking shelves. Install both shelves.

Never place samples or product on the oven chamber floor. The floor runs hotter than the shelf temperatures. All heating specifications for the oven are for shelving temperatures.

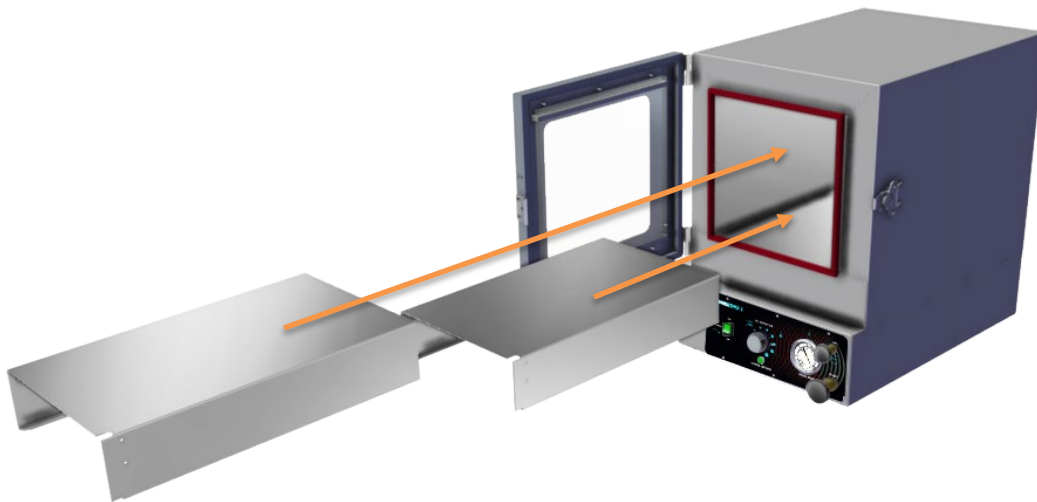

1. Carefully slide one shelf into position on the chamber floor.
2. Place the second shelf on top of it.

# INSTALLATION

## CONNECT TO THE VACUUM SUPPLY

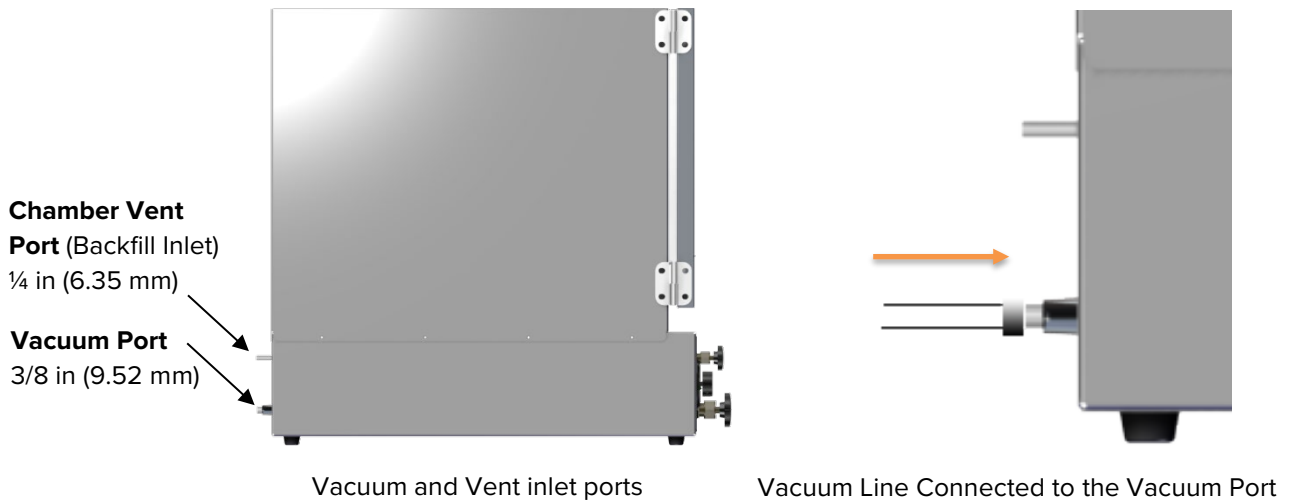











Use clamps to secure tubing to the Vacuum Port and Chamber Vent Port (backfill inlet).

- **The Vacuum Port – 3/8 Inch (9.52 mm) OD**
  - Connect a vacuum supply capable of supplying up to -29 inches of mercury (inHg) of vacuum to this port. Chamber atmosphere is evacuated through this port.
  - This port is opened and closed by the Vacuum Valve control on the front control panel.
- **The Chamber Vent Port (Backfill Inlet) – 1/4 Inch (6.35 mm) OD**
  - This intake port allows external atmosphere to backfill the oven chamber when the chamber Vent Valve control on the front control panel is set to open.
  - Optional: An inert backfill gas supply source may be connected to this port. **The maximum allowed pressure for a backfilling gas is 15 psi measured at the inlet port.**

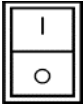

# GRAPHIC SYMBOLS

The unit is provided with multiple graphic symbols on its exterior. The symbols identify hazards and the functions of the adjustable components, as well as important notes in the user manual.

Symbol	Definition
	Consult the user manual Consulter le manuel d'utilisation
	Temperature display Indique l'affichage de la température
	Potential shock hazard Risque de choc électrique
	AC Power Repère le courant alternatif
	I/ON O/OFF I indique que l'interrupteur est en position marche. O indique que le commutateur est en position d'arrêt.
	Protective earth ground Terre électrique
	Manually adjustable Indique un réglage manuel
	Recycle the unit. Do not dispose of in a landfill. Recycler l'unité. Ne jetez pas dans une décharge.
	Caution hot surface Attention surface chaude
	Indicates the oven is heating Le four chauffe





# CONTROL OVERVIEW

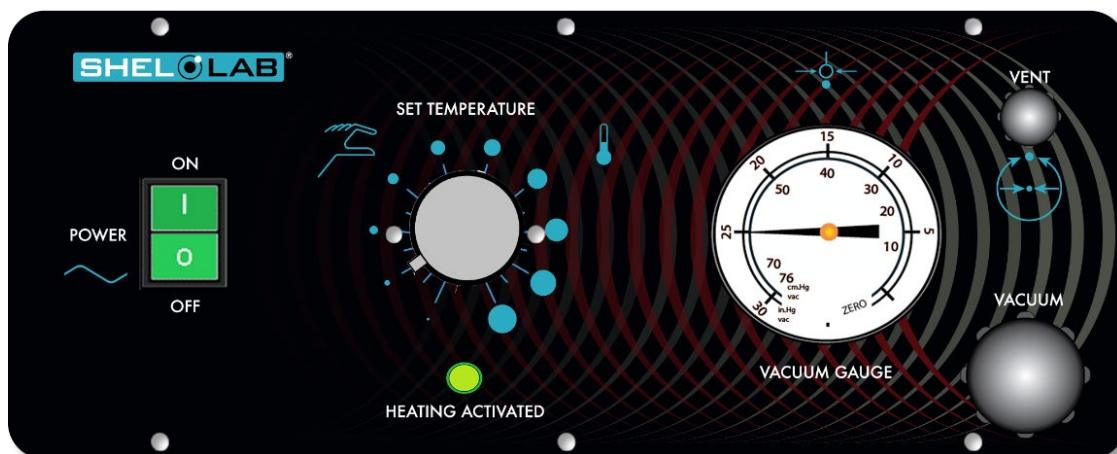

Figure 2: Control Panel

## Power Switch

Power is supplied to the unit when the switch is in the ( I ) ON position.



## Temperature Control Dial

This graduated dial sets the oven operating temperature. The dial is marked with 10 major increments and 9 minor increments, which can be used as index points for setting and returning to temperature levels.

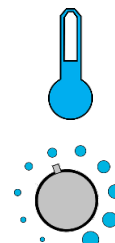

## Heating Activated Light

The green light located above the label HEATING ACTIVATED and illuminates whenever the oven elements are being powered to heat the chamber.



# CONTROL OVERVIEW



## Vacuum Gauge

This gauge indicates the level of vacuum within the chamber. The dial displays a vacuum pressure range of 0 – 76 cmHg and 0 – 30 inHg, with 30 inHg. Zero indicates ambient atmospheric pressure and 30 indicates a perfect vacuum level.

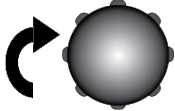

Close

## Vacuum Control Valve

This valve adjusts the level of vacuum draw applied to the oven chamber through the 3/8in Vacuum Port on the back of the oven.

- When **open**, this valve allows a connected vacuum supply to evacuate the oven chamber.
- In the **closed** position, the valve closes off the vacuum draw.

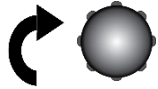

Close

## Vent Control Valve

This valve controls the oven chamber Vent Port (backfill inlet) on the back of the oven.

- In the **open** position, the oven chamber is open to external atmosphere through the Vent Port.
  - Optional: An inert or clean backfilling gas supply connected to the Vent Port will flow gas from the pressurized supply to the oven chamber when the Vent Valve is open.
- When the valve control is in the **closed** position, the chamber is cut off from external atmosphere and any backfill gas supply.
  - **The vent valve must be closed before evacuating the chamber.** Failure to do so may result in damage to the vacuum pump.

Safe operation of the oven is dependent on the actions and behavior of the oven operators.

**Operating personnel must read and understand the Operating Precautions in this section prior to operating the oven.** The operators must follow these instructions to prevent injuries and to safeguard their health, environment, and the materials being treated in the oven, as well as to prevent damage to the oven. Failure to adhere to the Operating Precautions, deliberately or through error, is a hazardous behavior on the part of the operator.



Le fonctionnement sûr du four dépend des actions et du comportement des opérateurs du four. Le personnel d'exploitation doit lire et comprendre les consignes de sécurité et les précautions d'utilisation de cette section avant d'utiliser le four. Les opérateurs doivent suivre ces instructions pour prévenir les blessures et protéger leur santé, leur environnement et les matériaux traités dans le four, ainsi que pour éviter d'endommager le four. Le non-respect des consignes de sécurité et des précautions d'utilisation, délibérément ou par erreur, est un comportement dangereux de la part de l'opérateur.



## ***OPERATING PRECAUTIONS***

- Do not use this oven in unsafe improper applications that produce flammable or combustible gases, vapors, liquids, or fuel-air mixtures in quantities that can become potentially explosive.
- Outgassed byproducts may be hazardous to or noxious for operating personnel. Vacuum pump exhaust should be vented to a location outside the workspace in a safe manner in accordance with all applicable laws, ordinances, and regulations. Do not operate the oven in an unsafe area with noxious fumes.
- Do not use this oven for applications heating hazardous fibers or dust. These items can become airborne and come into contact with hot surfaces.
- Individual ovens are not rated to be explosion proof. Follow all building certification requirements and laws for Class I, II, or III locations as defined by the US National Electric Code.
- The bottom surface of the chamber should not be used as a work surface. It runs hotter than the shelf temperatures. Never place samples or product on the oven chamber floor.
- Do not place sealed or filled containers in the oven. These may burst open when the chamber is under vacuum.
- Do not place alcohol or mercury thermometers in the oven. With improper use, they can rupture.
- Do not move the oven until it has finished cooling.

---

**Warning Hot Surfaces:** These areas are marked with Hot Surface labels. Proper protective equipment should be employed to minimize the risk of burns.

**Avertissement Surface Chaude:** Ces zones sont marquées avec des étiquettes de surface chaude. Un équipement de protection approprié devrait être utilisé pour minimiser le risque de brûlures.

---



## *THEORY OF OPERATION*

These units are intended for use in closed-cycle, under-vacuum applications.

### **Vacuum**



The oven chamber is evacuated by a vacuum pump or building system. The vacuum supply is connected to the Vacuum Port on the back of the oven. The current level of relative vacuum is displayed on the Vacuum Gauge on the main control panel.

The oven chamber is pressure rated to -0.09 inHg gauge pressure at near sea level. Vacuum levels obtained in the oven chamber are dependent on pump performance, valve settings, and the nature of the application or process, including the volume of material outgassed. The maximum attainable vacuum is governed by altitude above sea level (see page 36 for more information).

The chamber must be sealed off from the room atmosphere prior to the start of a vacuum baking application. The oven is not built to operate with the chamber exposed to free atmosphere or to circulate air within the chamber. Running the oven with the door or the vent control valve open risks destroying the vacuum pump and damaging the integrity of the oven chamber.

Vacuum pumps and door gaskets should be selected based on the application or process. Some gaskets are vulnerable to different chemicals, and vacuum pumps vary in suitability and safety depending on the outgassed byproduct types and moisture level produced in the oven chamber.

### **Gas Backfill**



An inert gas supply, such as gas nitrogen ( $\text{GN}_2$ ) can be connected to the vent intake port located on the back of the oven. The gas is used to backfill an evacuated oven chamber to avoid particulate contamination or oxidation. The maximum allowed backfill pressure is 15 psi of delivery at the oven vent port.

## Heating in a Vacuum

In conventional ovens, a powered element transfers heat into the chamber air. The heated air then circulates by natural convection or blower fan action, and surrounds the product on the shelves, gradually bringing it to temperature. In a vacuum oven, there is no atmosphere to transport heat evenly from the elements to the product. Instead, heat transport takes place primarily by conduction. The oven heating elements are located inside the chamber walls, which in turn transfer heat to the shelves. Each shelf then transports heat to the products or samples resting on it.



Direct radiant heating through infrared emission in a vacuum environment provides poor temperature uniformity compared to conductive heating.

SVAC economy ovens rely on natural heat radiation for cooling. The oven can achieve a low-end operating temperature of the ambient room temperature plus the oven waste heat.

Allowing the oven to heat up with atmosphere in the chamber can result in a significant heat spike when the chamber is brought under vacuum.

# OPERATION

**Note:** You may place a dial thermometer in the oven chamber prior to turning on the oven if you will be setting the oven to a specific temperature. See page 34 for thermometer requirements.

## *PUT THE OVEN INTO OPERATION*

Verify all the required procedures in the Installation section have been carried out. Then perform the following steps and procedures to prepare the oven for use in a new location.

### 1. Plug in the Oven



### 2. Verify the Oven Valves are Set to Closed

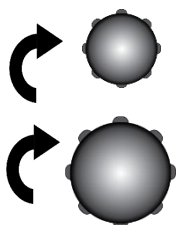

Check that the oven chamber door is closed and latched and that the vent and vacuum valves are both in the closed position.

Always verify the oven chamber is sealed prior to starting the oven to help safeguard your vacuum pump from prolonged exposure to streaming atmosphere.

### 3. Turn on the Oven

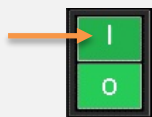

Place the oven **Power Switch** in the ON ( I ) position.

### 4. Turn on the Vacuum Pump



### 5. Verify the vacuum system integrity

**Evacuate the Oven Chamber** for 10 minutes to verify the integrity of the vacuum supply system. See page 32.



Minimum 10 Minutes

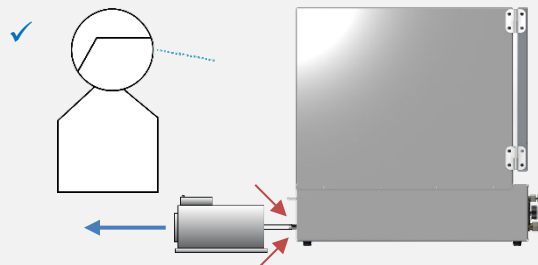

Continued next page

Continued from the previous page

## 6. Set the Oven Chamber to an Approximate Temperature

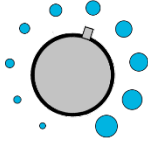

See the [Select Approximate Oven Temperature](#) procedure on page 33.



### Optional: Temperature Matching

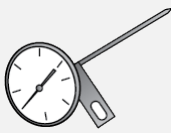

Set the oven to a specific temperature using a reference thermometer.

- See the [Temperature Matching](#) procedure on page 34.

The oven is now ready for use

# OPERATION



## EVACUATING THE OVEN CHAMBER

Put the oven chamber under vacuum for at least 10 minutes when first putting the oven into operation in a new location to verify the integrity of the vacuum supply system.

### Evacuate the Oven Chamber

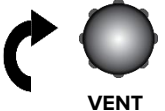
- 

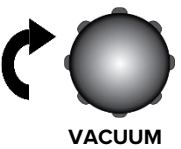
Verify the Vent Valve control is in the closed position (all the way clockwise)
- 

Verify the Vacuum Valve control is in the closed position (all the way clockwise).

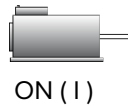
**Note:** Always make sure the Vacuum and Vent valves are closed prior to applying vacuum to the chamber.
- 

Turn on the pump if it is not already on.

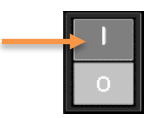
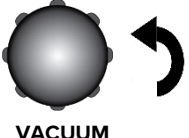
- 

Open the oven Vacuum Valve, turning it all the way counterclockwise to bring the oven chamber under vacuum draw.

  - The Vacuum Gauge needle on the front panel should begin rotating counterclockwise as the chamber evacuates.

### Hold At Vacuum

- 

Keep the oven chamber under vacuum throughout your baking application to help evacuate outgassed byproducts.

The achievable vacuum level in the oven chamber is dependent on altitude above sea level as well as the vacuum pump flow rate and the volume of outgassed byproducts.

### Backfill the Oven Chamber

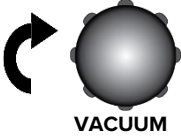
- 

Turn the Vacuum Valve control back to the closed position (clockwise) to protect the vacuum pump from exposure to streaming atmosphere.

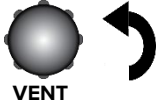
  - The pump may remain on.
- 

Slowly turn the Vent Valve control to the Open position to backfill the oven chamber with atmosphere or gas.

End of procedure



# OPERATION

## SELECT APPROXIMATE OVEN TEMPERATURE



### 1. Set the Approximate Oven Temperature

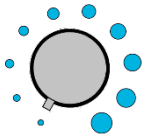

Low Temp

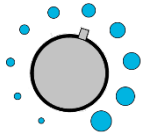

Med Temp

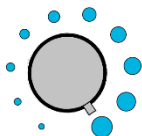

High Temp

Turn the Temperature controller knob to the approximate position for your application, using the graduated dial as a reference guide.

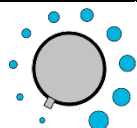
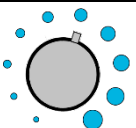
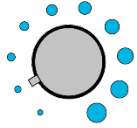
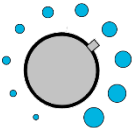
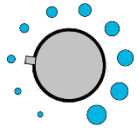
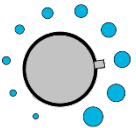
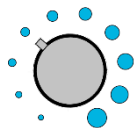
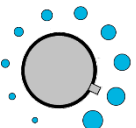
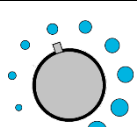
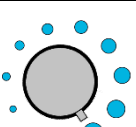
Controller Position	Approximate Temperature	Controller Position	Approximate Temperature
	30 – 48°C*		125 – 143°C
	49 – 67°C		144 – 162°C
	68 – 86°C		163 – 181°C
	87 – 105°C		182 – 200°C
	106 – 124°C		200 – 210°C*

\*The achievable low- and high-end operating temperatures are partly dependent on the ambient room temperature.

## *TEMPERATURE MATCHING*

This procedure sets the oven to a specific temperature using a reference thermometer.

**Required Thermometer Type:** A dial style bimetallic thermometer. Do not use an alcohol or mercury thermometer. These can rupture under vacuum.

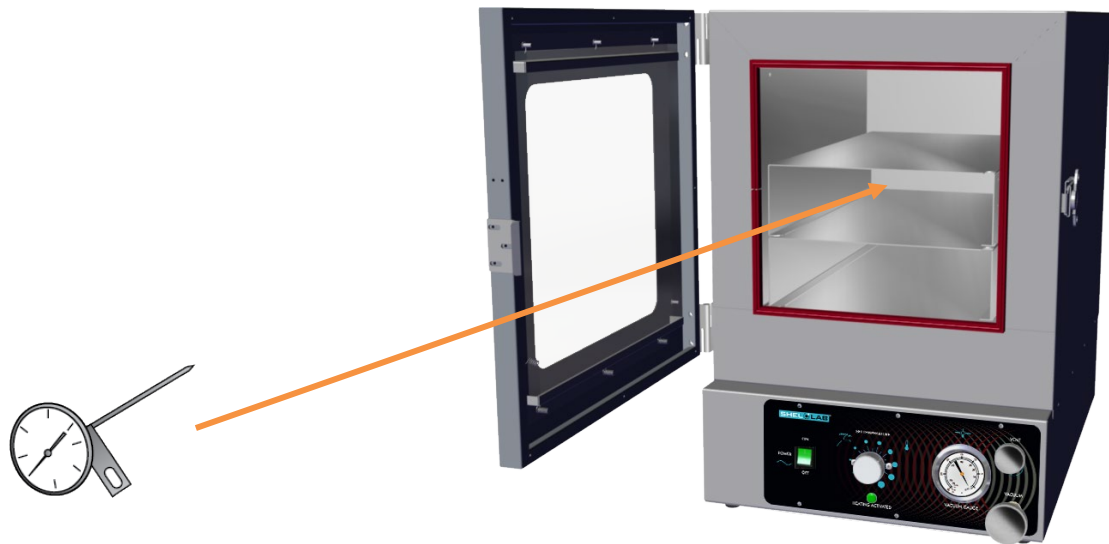

1. Place the thermometer on the top shelf of the oven where the face will be visible through the glass door.
  - Make sure the temperature sensing probe is in maximum surface area contact with the middle of the shelf.
  - **No alcohol or mercury thermometers.**
2. Evacuate the oven chamber, see page 32.
3. Set the approximate oven temperature, see page 33.

## Temperature Matching (continued)

### 4. Wait 45 minutes for the chamber temperature to stabilize



- The chamber must be evacuated to accurately match the dial setting to a specific temperature.

### 5. Check the thermometer temperature

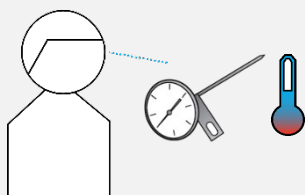

- If the thermometer temperature matches your application temperature or is close enough, the temperature matching procedure is now complete.

Record the controller dial position.

**-OR-**

- See the next step if the difference falls outside the acceptable range of your application.

### 6. Adjust the temperature dial

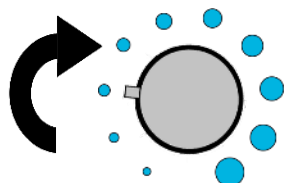

- Adjust the dial up or down and wait 20 minutes before re-checking the reference thermometer.
- If the oven fails to achieve your application temperature in 5 attempts, contact Technical Support.

End of Procedure

# OPERATION

## ***MAXIMUM OBTAINABLE VACUUM***

The maximum vacuum obtainable is set by the altitude of the oven workspace or laboratory environment. The atmosphere is less dense at higher altitudes than at sea level. While a vacuum pump will evacuate the same percentage of atmosphere from the oven chamber, less overall pressure is expelled because of the reduced density.

Altitude (Feet)	Altitude (Meters)	Atmospheric Pressure	Maximum Vacuum Level Attainable*
Sea Level	Sea Level	14.70 psi	-29.9 inHg
1000ft	305m	14.16 psi	-28.9 inHg
2000ft	610m	13.66 psi	-27.8 inHg
3000ft	914m	13.16 psi	-26.8 inHg
4000ft	1219m	12.68 psi	-25.8 inHg
5000ft	1524m	12.22 psi	-24.9 inHg
6000ft	1829m	11.77 psi	-24.0 inHg
7000ft	2134m	11.33 psi	-23.1 inHg
8000ft	2438m	10.91 psi	-22.2 inHg
9000ft	2743m	10.50 psi	-21.4 inHg
10,000ft	3048m	10.10 psi	-20.6 inHg

\*In gauge pressure

## ***PRESSURE UNITS CONVERSION CHART***

	InHg	kPa	Kgf/cm <sup>2</sup>	bar	psi	mmHG	mmH <sub>2</sub> O
1 inHg	1	3.3863	0.0345	0.3386	0.4911	25.400	345.32
1 kPa	0.2953	1	0.0102	0.01	0.1450	7.5006	101.97
1 Kgf/cm <sup>2</sup>	28.9590	98.0665	1	0.9806	14.2233	735.55	10000.27
1 bar	29.5300	100	1.0197	1	14.5037	750.06	10197.44
1 psi	2.0360	6.8947	0.0703	0.0689	1	51.7150	703.09
1 mmHG	0.0394	1.3332	0.0014	0.0013	0.0193	1	13.5954
1 mmH <sub>2</sub> O	0.0028	0.0098	0.0001	0.0001	0.0014	0.0029	1

---

**Warning:** Disconnect the unit from its power supply prior to maintenance or cleaning of this unit.

**Avertissement:** Avant d'effectuer toute maintenance ou entretien de cet appareil, débrancher le cordon secteur de la source d'alimentation.

---



## ***CLEANING AND DISINFECTING***

If a hazardous material or substance has spilled in the unit, immediately initiate your site Hazardous Material Spill Containment protocol. Contact your local Site Safety Officer and follow instructions per the site policy and procedures.

- Periodic cleaning is required.
- Do not use spray-on cleaners or disinfectants. These can leak through openings and coat electrical components.
- Do not use cleaners or disinfectants that contain solvents capable of harming paint coatings or stainless-steel surfaces. **Do not use chlorine-based bleaches or abrasives; these will damage the chamber liner.**
- Consult with the manufacturer or their agent if you have any doubts about the compatibility of decontamination or cleaning agents with the parts of the equipment or with material contained in it.

---

**Warning:** Exercise caution if cleaning the unit with alcohol or flammable cleaners. Always allow the unit to cool down to room temperature prior to cleaning and make sure all cleaning agents have evaporated or otherwise been completely removed prior to putting the unit back into service.

**Avertissement:** Soyez prudent lorsque vous nettoyez l'appareil avec de l'alcool ou des produits de nettoyage inflammables. Laissez toujours refroidir l'appareil à la température ambiante avant le nettoyage et assurez-vous que tous les produits de nettoyage se sont évaporés ou ont été complètement enlevés avant de remettre l'appareil en service.

---



### **Oven Chamber Cleaning Guidelines**

1. Disconnect the unit from its power supply.
2. Remove any removable chamber accessory items such as shelving if present.
3. Use 99% isopropyl alcohol to clean chamber surfaces and shelving. Apply using lint-free wipes.
4. Take special care when cleaning around temperature sensor probes. Do not clean the probes.
5. Clean all removable accessories and components.
6. Verify the cleaning alcohol has evaporated completely from all chamber surfaces and accessories prior to reconnecting the unit to its power source.

## Oven Exterior Cleaning Guidelines

1. Disconnect the unit from its power supply.
2. The manufacturer recommends cleaning the unit with a mild soap and water solution.
  - **Do not use abrasive cleaners**, these will damage metal surfaces.
  - Cleaning agents must be compatible with steel and powder coat paint surfaces.
  - Do not use deionized water to rinse or clean with.
3. Rinse with distilled water and wipe dry with a soft cloth.

**Cleaning Agents Warranty Statement:** *The manufacturing warranty is void if the oven is cleaned using acids or other corrosive cleaners capable of harming cold rolled steel, painted steel, or stainless-steel surfaces. These include chlorides and cleaners containing chlorides as well as hydrobromic, hydrochloric, and hydrofluoric acids. Nitric acid cleaners may be used in small amounts and may help maintain or restore the passivation of stainless-steel surfaces. If nitric acid is used, ensure all cleaner residue is removed from the chamber before restoring the oven to operation.*

*The manufacturer recommends isopropyl alcohol for cleaning the chamber surfaces and shelving.*

## ***MAINTAINING ATMOSPHERIC INTEGRITY***

Periodically, inspect the door latch, trim, catch, and gasket for signs of deterioration. Failure to maintain the integrity of the door system shortens the lifespan of the unit.

The gasket should be replaced if it is dry, cracked, or otherwise showing a loss of elasticity.

## ***ELECTRICAL COMPONENTS***

Electrical components do not require maintenance. If the oven fails to operate as specified, please contact your distributor or [Customer Support](#) for assistance.

## ***VACUUM PUMP MAINTENANCE***

Refer to the operation manual supplied with your vacuum pump for recommended maintenance routines such as oil levels, replacement of sorbent charge, and exhaust filter change-outs. **Contact your vacuum pump supplier if you do not have an operation manual.**

## ***STORAGE***

To prepare the unit for storage, remove all shelves, dry the chamber completely, and disconnect the power supply. Be certain that the door is positively locked in the closed position.

# UNIT SPECIFICATIONS

SVAC1E and SVAC2E units are 110-120 VAC. SVAC1E-2 and SVAC2E-2 units are 220-240 VAC. Please refer to the oven data plate for individual electrical specifications.

Technical data specified applies to units with standard equipment at an ambient temperature of 25°C and at nominal voltage. The temperatures specified are determined in accordance with factory standards following DIN 12880 respecting the recommended wall clearances of 10% of the height, width, and depth of the inner chamber. All indications are average values, typical for units produced in the series. We reserve the right to alter technical specifications at all times.

## *WEIGHT*

Model	Shipping Weight	Unit Weight
SVAC1E	93 lb / 43 kg	59.4 lb / 27.0 kg
SVAC2E	154 lb / 70 kg	108.0 lb / 49.0 kg
SVAC1E-2	93 lb / 43 kg	59.4 lb / 27.0 kg
SVAC2E-2	154 lb / 70 kg	108.0 lb / 49.0 kg

## *DIMENSIONS*

### Inches

Model	Exterior W × D × H	Interior W × D × H
SVAC1E	15.5 x 19.0 x 22.5 in	9.0 x 12.0 x 9.0 in
SVAC2E	18.5 x 27.8 x 25.3 in	12.0 x 20.0 x 12.0 in
SVAC1E-2	15.5 x 19.0 x 22.5 in	9.0 x 12.0 x 9.0 in
SVAC2E-2	18.5 x 27.8 x 25.3 in	12.0 x 20.0 x 12.0 in

### Millimeters

Model	Exterior W × D × H	Interior W × D × H
SVAC1E	394 x 483 x 572 mm	228 x 304 x 228 mm
SVAC2E	470 x 705 x 641 mm	304 x 508 x 304 mm
SVAC1E-2	394 x 483 x 572 mm	228 x 304 x 228 mm
SVAC2E-2	470 x 705 x 641 mm	304 x 508 x 304 mm

# UNIT SPECIFICATIONS

## *CAPACITY*

Model	Cubic Feet	Liters
SVAC1E	0.56	15.9
SVAC2E	1.67	47.2
SVAC1E-2	0.56	15.9
SVAC2E-2	1.67	47.2

## *SHELF CAPACITY BY WEIGHT*

Model	Per Shelf	Max Total Load	Max No. Shelves
SVAC1E	35.0 lb / 15.8 kg*	70.0 lb / 31.7 kg**	2
SVAC2E	35.0 lb / 15.8 kg*	70.0 lb / 31.7 kg**	2
SVAC1E-2	35.0 lb / 15.8 kg*	70.0 lb / 31.7 kg**	2
SVAC2E-2	35.0 lb / 15.8 kg*	70.0 lb / 31.7 kg**	2

\*35 lb / 15.8 kg with weight evenly distributed across the shelf.

\*\*70 lb / 31.7 kg total load. Exceeding this limit risks damaging the chamber liner.

## *VACUUM*

### **Operational Vacuum Range**

inHg	cmHg
3.0 – 29.9	0 – 76

### **Vacuum Gauge Range**

inHg	cmHg
0.0 – 30.0	0.0 – 76.0



# UNIT SPECIFICATIONS

## *TEMPERATURE*

### Range, Stability, and Uniformity

Model	Range	Stability	Uniformity
SVAC1E	Ambient +15° to 210°C	±0.5°C @ 100°C	±9.0 @ 110
SVAC2E	Ambient +15° to 210°C	±0.5°C @ 100°C	±9.0 @ 110
SVAC1E-2	Ambient +15° to 210°C	±0.5°C @ 100°C	±9.0 @ 110
SVAC2E-2	Ambient +15° to 210°C	±0.5°C @ 100°C	±9.0 @ 110

**Time to Temperature:** From an ambient temperature of +20°C.

Model	Heat up to 80°C	Heat up to 150°C	Heat up to 210°C
SVAC1E	30 Minutes	45 Minutes	120 Minutes
SVAC2E	30 Minutes	45 Minutes	120 Minutes
SVAC1E-2	30 Minutes	45 Minutes	120 Minutes
SVAC2E-2	30 Minutes	45 Minutes	120 Minutes

## *POWER*

Model	AC Voltage	Amperage	Frequency
SVAC1E	115	5.0	50/60 Hz
SVAC2E	115	10.0	50/60 Hz
SVAC1E-2	230	2.5	50/60 Hz
SVAC2E-2	230	5.5	50/60 Hz



# PARTS LIST

See next page for gaskets.

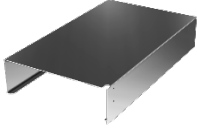
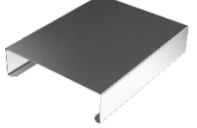
Description	Parts Number	Description	Parts Number
Shelf, SVAC2Es	 <b>5680567</b>	Shelf, SVAC1Es	 <b>5680566</b>

### *Ordering Parts and Consumables*

If you have the Part Number for an item, you may order it directly from Sheldon Manufacturing by calling 1-800-322-4897 extension 3. If you are not certain that you have the correct Part Number, or if you need that specific item, please contact Sheldon Technical Support for help at 1-800-322-4897 extension 4 or (503) 640-3000. Please have the **model** and **serial number** of the oven ready, as Tech Support will need this information to match your unit to its correct part.

# PARTS LIST

## REPLACEMENT GASKETS

Available Gasket Types	Part Number
<p><b>Silicon</b>, black or red, (comes with oven), rated to 230°C</p> <p><b>Applications:</b> General and high temperature</p> <p><b>Resistant to:</b> Moderate or oxidizing chemicals, ozone, and concentrated sodium hydroxide</p> <p><b>Attacked by:</b> Many solvents, oils, concentrated acids, and diluted sodium hydroxide</p>	<p><b>SVAC1Es:</b> 3450706</p> <p><b>SVAC2Es:</b> 3450707</p>
<p><b>Buna</b> rated to 105°C</p> <p><b>Applications:</b> Solvent</p> <p><b>Resistant to:</b> Many hydrocarbons, fats, oils, greases, and hydraulic fluids.</p> <p><b>Attacked by:</b> Ozone (except PVC blends), ketones, esters, aldehydes, chlorinated, and nitro hydrocarbons.</p>	<p><b>SVAC1Es:</b> 3450712</p> <p><b>SVAC2Es:</b> 3450708</p>
<p><b>Fluorosilicone</b> rated to 175°C</p> <p><b>Applications:</b> Acidic</p> <p><b>Resistant to:</b> Moderate or oxidizing chemicals, ozone, aromatic chlorinated solvents, and bases.</p> <p><b>Attacked by:</b> Brake fluids, hydrazine, and ketones.</p>	<p><b>SVAC1Es:</b> 3450610</p> <p><b>SVAC2Es:</b> 3450611</p>
<p><b>Viton®</b> rated to 205°C</p> <p><b>Applications:</b> Acidic</p> <p><b>Resistant to:</b> All aliphatic, aromatic, and halogenated hydrocarbons, acids, and animal and vegetable oils.</p> <p><b>Attacked by:</b> Ketones, low molecular weight esters, and compounds containing nitro.</p>	<p><b>SVAC1Es:</b> 3450669</p> <p><b>SVAC2Es:</b> 3450670</p>
<p><b>Gasket Dimensions</b></p> <p><b>SVAC1Es</b> – 9.2 X 9.3 Inches (229 x 229 mm)</p> <p><b>SVAC2Es</b> – 12 x 12 Inches (305 x 304 mm)</p>	





**SHELDON**  
MANUFACTURING, INC

P.O. Box 627  
Cornelius, OR 97113  
USA

[support@sheldonmfg.com](mailto:support@sheldonmfg.com)  
[sheldonmanufacturing.com](http://sheldonmanufacturing.com)

1-800-322-4897  
(503) 640-3000  
FAX: 503 640-1366