



DOC342.53.80534

# TL2310

03/2021, Edition 5

**User Manual**

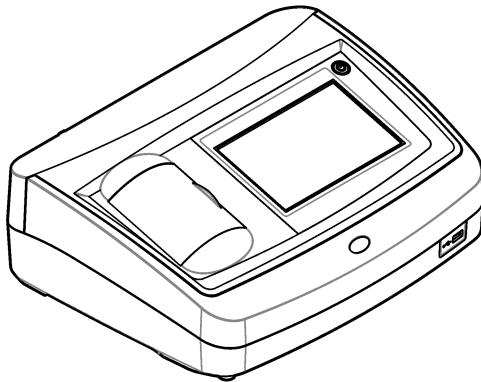



|  |    |
|--|----|
| <b>Section 1 Specifications</b> .....                        | 3  |
| <b>Section 2 General information</b> .....                   | 4  |
| 2.1 Safety information .....                                 | 4  |
| 2.1.1 Use of hazard information .....                        | 4  |
| 2.1.2 Precautionary labels .....                             | 5  |
| 2.1.3 Certification .....                                    | 5  |
| 2.1.4 Korean certification .....                             | 6  |
| 2.2 Product overview .....                                   | 6  |
| 2.3 Product components .....                                 | 7  |
| <b>Section 3 Installation</b> .....                          | 8  |
| 3.1 Installation guidelines .....                            | 8  |
| 3.2 Connect to external devices (optional) .....             | 8  |
| <b>Section 4 Startup</b> .....                               | 9  |
| <b>Section 5 User interface and navigation</b> .....         | 9  |
| <b>Section 6 Operation</b> .....                             | 11 |
| 6.1 Configure the instrument settings .....                  | 11 |
| 6.1.1 Configure the measurement settings .....               | 12 |
| 6.1.2 Add operator IDs .....                                 | 12 |
| 6.1.3 Add sample IDs .....                                   | 13 |
| 6.1.3.1 Import sample IDs (optional) .....                   | 13 |
| 6.2 Calibrate the turbidimeter with StablCal Standards ..... | 14 |
| 6.2.1 Calibration notes .....                                | 14 |
| 6.2.2 Prepare the StablCal standards .....                   | 14 |
| 6.2.3 Configure the calibration settings .....               | 15 |
| 6.2.4 StablCal calibration procedure .....                   | 16 |
| 6.2.5 StablCal standards storage .....                       | 17 |
| 6.3 Calibration verification .....                           | 17 |
| 6.3.1 Optical system check .....                             | 17 |
| 6.3.2 Configure the verification settings .....              | 18 |
| 6.3.3 Gelex notes .....                                      | 18 |
| 6.3.4 Measure the Gelex secondary turbidity standards .....  | 18 |
| 6.3.5 Verification procedure .....                           | 19 |
| 6.4 Turbidity measurement .....                              | 20 |
| 6.4.1 Measurement notes .....                                | 20 |
| 6.4.2 Sample collection .....                                | 21 |
| 6.4.3 Clean the sample cell .....                            | 21 |
| 6.4.4 Turbidity measurement procedure .....                  | 22 |
| 6.5 Data management .....                                    | 23 |
| 6.5.1 Show the recorded data .....                           | 23 |
| 6.5.2 Send data to a connected device .....                  | 23 |
| 6.5.3 Delete data from the data log .....                    | 24 |
| 6.5.4 Backup the instrument settings .....                   | 24 |
| 6.6 Measurement techniques .....                             | 24 |
| 6.6.1 Indexing a single sample cell .....                    | 25 |
| 6.6.2 Matching sample cells .....                            | 26 |

## Table of Contents

---

|  |           |
|--|-----------|
| 6.6.3 Prepare dilution water .....                       | 27        |
| 6.6.4 Using a flow cell .....                            | 27        |
| 6.6.4.1 Prepare the flow cell .....                      | 28        |
| 6.6.4.2 Flow cell operation .....                        | 29        |
| 6.6.4.3 Adjust the flow .....                            | 29        |
| 6.6.4.4 Flow cell maintenance .....                      | 29        |
| 6.6.4.5 Clean a flow cell assembly .....                 | 29        |
| 6.6.4.6 Flow cell storage .....                          | 29        |
| 6.6.5 Remove air bubbles from the sample .....           | 30        |
| 6.6.6 Prevent condensation on a sample cell .....        | 30        |
| 6.6.7 Using the air purge system .....                   | 30        |
| <b>Section 7 Maintenance .....</b>                       | <b>31</b> |
| 7.1 Clean spills .....                                   | 31        |
| 7.2 Clean the instrument .....                           | 31        |
| 7.3 Instrument utilities .....                           | 32        |
| 7.4 Install an instrument update .....                   | 32        |
| <b>Section 8 Troubleshooting .....</b>                   | <b>32</b> |
| <b>Section 9 Replacement parts and accessories .....</b> | <b>34</b> |

## Section 1 Specifications

Specifications are subject to change without notice.

| Specification               | Details  |
|-----------------------------|--|
| Measurement method          | Nephelometric  |
| Regulatory                  | Meets ISO 7027, DIN EN 27027 and DIN 38404<br>ASTM D7315 - Standard Test Method for Determination of Turbidity Above 1 Turbidity Unit (TU) in Static Mode<br>ASTM D6855 - Standard Test Method for Determination of Turbidity Below 5 NTU in Static Mode |
| Dimensions (W x D x H)      | 39.5 x 30.5 x 15.3 cm (15.6 x 12.0 x 6.02 in.)   |
| Weight                      | 2.9 kg (6.4 lb)  |
| Enclosure                   | IP30; indoor use only  |
| Protection Class            | External power supply: Protection Class I; instrument: Protection Class II   |
| Pollution degree            | 2  |
| Installation category       | External power supply: Category II; instrument: Category I   |
| Power requirements          | Instrument: 12 VDC, 3.4 A; power supply: 100–240 VAC, 50/60 Hz   |
| Operating temperature       | 0 to 40 °C (32 to 104 °F)  |
| Storage temperature         | –20 to 60 °C (–4 to 140 °F)  |
| Humidity                    | 5 to 95% relative humidity, non-condensing   |
| Display                     | 17.8 mm (7 in.) color touch screen   |
| Light source                | Light-emitting diode (LED) at 860 ± 30 nm  |
| Measurement units           | FNU and NTU  |
| Range                       | NTU/FNU: 0–1000  |
| Accuracy <sup>1, 2, 3</sup> | ±2% of reading plus 0.01 FNU/NTU from 0–1000 FNU/NTU   |
| Resolution                  | Turbidity: 0.001 FNU/NTU (on lowest range)   |
| Repeatability               | ±1% of reading or 0.01 FNU/NTU, whichever is greater (under reference conditions)  |
| Response time               | Signal averaging off: 6.8 seconds<br>Signal averaging on: 14 seconds (when 10 measurements are used to calculate the average)  |
| Stabilization time          | Immediately  |
| Reading modes               | Single, continuous, Rapidly Settling Turbidity™, signal averaging on or off  |
| Communication               | USB  |

<sup>1</sup> Turbidity specifications identified using recently prepared formazin standard and matched 1-inch sample cells.

<sup>2</sup> Intermittent electromagnetic radiation of 3 volts/meter or greater may cause slight accuracy shifts.

<sup>3</sup> Reference conditions: 23 (± 2) °C, 50 (± 10)% RH noncondensing, 100–240 VAC, 50/60 Hz

| Specification       | Details   |
|---------------------|---|
| Interface           | 2 USB-A ports for USB flash drive, Seiko DPU-S445 printer, keyboard and barcode scanner   |
| Datalog             | Maximum 2000 total logs, includes reading log, verification log and calibration log   |
| Air purge           | Dry nitrogen or instrument grade air (ANSI MC 11.1, 1975)<br>0.1 scfm at 69 kPa (10 psig); 138 kPa (20 psig) maximum<br>Hose barb connection for $\frac{1}{8}$ -inch tubing |
| Sample cells        | Round cells 95 x 25 mm (3.74 x 1 in.) borosilicate glass with rubber-lined screw caps   |
| Sample requirements | 25 mm sample cell: 20 mL minimum<br>0 to 70 °C (32 to 158 °F)   |
| Certification       | CE, KC, RCM   |
| Warranty            | 1 year (EU: 2 years)  |

## Section 2 General information

In no event will the manufacturer be liable for direct, indirect, special, incidental or consequential damages resulting from any defect or omission in this manual. The manufacturer reserves the right to make changes in this manual and the products it describes at any time, without notice or obligation. Revised editions are found on the manufacturer's website.

### 2.1 Safety information

The manufacturer is not responsible for any damages due to misapplication or misuse of this product including, without limitation, direct, incidental and consequential damages, and disclaims such damages to the full extent permitted under applicable law. The user is solely responsible to identify critical application risks and install appropriate mechanisms to protect processes during a possible equipment malfunction.

Please read this entire manual before unpacking, setting up or operating this equipment. Pay attention to all danger and caution statements. Failure to do so could result in serious injury to the operator or damage to the equipment.

Make sure that the protection provided by this equipment is not impaired. Do not use or install this equipment in any manner other than that specified in this manual.

#### 2.1.1 Use of hazard information

##### **▲ DANGER**

Indicates a potentially or imminently hazardous situation which, if not avoided, will result in death or serious injury.

##### **▲ WARNING**

Indicates a potentially or imminently hazardous situation which, if not avoided, could result in death or serious injury.

##### **▲ CAUTION**



Indicates a potentially hazardous situation that may result in minor or moderate injury.

##### **NOTICE**

Indicates a situation which, if not avoided, may cause damage to the instrument. Information that requires special emphasis.

## 2.1.2 Precautionary labels

Read all labels and tags attached to the instrument. Personal injury or damage to the instrument could occur if not observed. A symbol on the instrument is referenced in the manual with a precautionary statement.

|   |   |
|---|---|
|  | This symbol, if noted on the instrument, references the instruction manual for operation and/or safety information.   |
|  | This symbol indicates the presence of a light source that may have the potential to cause minor eye injury. Obey all messages that follow this symbol to avoid potential eye injury.                                |
|  | Electrical equipment marked with this symbol may not be disposed of in European domestic or public disposal systems. Return old or end-of-life equipment to the manufacturer for disposal at no charge to the user. |

## 2.1.3 Certification

### EN 55011/CISPR 11 Notification Warning

This is a Class A product. In a domestic environment this product may cause radio interference in which case the user may be required to take adequate measures.

### Canadian Radio Interference-Causing Equipment Regulation, ICES-003, Class A:

Supporting test records reside with the manufacturer.

This Class A digital apparatus meets all requirements of the Canadian Interference-Causing Equipment Regulations.

Cet appareil numérique de classe A répond à toutes les exigences de la réglementation canadienne sur les équipements provoquant des interférences.

### FCC Part 15, Class "A" Limits

Supporting test records reside with the manufacturer. The device complies with Part 15 of the FCC Rules. Operation is subject to the following conditions:

1. The equipment may not cause harmful interference.
2. The equipment must accept any interference received, including interference that may cause undesired operation.

Changes or modifications to this equipment not expressly approved by the party responsible for compliance could void the user's authority to operate the equipment. This equipment has been tested and found to comply with the limits for a Class A digital device, pursuant to Part 15 of the FCC rules. These limits are designed to provide reasonable protection against harmful interference when the equipment is operated in a commercial environment. This equipment generates, uses and can radiate radio frequency energy and, if not installed and used in accordance with the instruction manual, may cause harmful interference to radio communications. Operation of this equipment in a residential area is likely to cause harmful interference, in which case the user will be required to correct the interference at their expense. The following techniques can be used to reduce interference problems:

1. Disconnect the equipment from its power source to verify that it is or is not the source of the interference.
2. If the equipment is connected to the same outlet as the device experiencing interference, connect the equipment to a different outlet.
3. Move the equipment away from the device receiving the interference.
4. Reposition the receiving antenna for the device receiving the interference.
5. Try combinations of the above.

## 2.1.4 Korean certification

 업무용을 위한 EMC 등급 A 장치에 대한  
사용자 지침  
사용자안내문  
A 급 기기 ( 업무용 방송통신기자재 )  
이 기기는 업무용 (A 급 ) 전자파적합기기로서 판매자 또는 사용자는 이 점을 주의하시기 바라며 , 가정  
외의 지역에서 사용하는 것을 목적으로 합니다.

## 2.2 Product overview

| <b>⚠ CAUTION</b>   |   |
|--|---|
|  | Fire hazard. This product is not designed for use with flammable liquids. |

The TL2310 laboratory turbidimeter measures the scattered light from water samples to determine the turbidity value of the samples. The instrument uses one detector at a 90-degree angle from the light source. The user can calibrate the instrument and verify the calibration at regular intervals.

The user interface uses a touch screen display. A Seiko DPU-S445 printer, USB flash drive or keyboard can connect to the USB ports. Refer to [Figure 1](#). The real-time clock with battery puts a time-date stamp on all of the data that is transmitted or recorded (i.e., reading log, calibration log and verification log).



**Figure 1 Product overview**

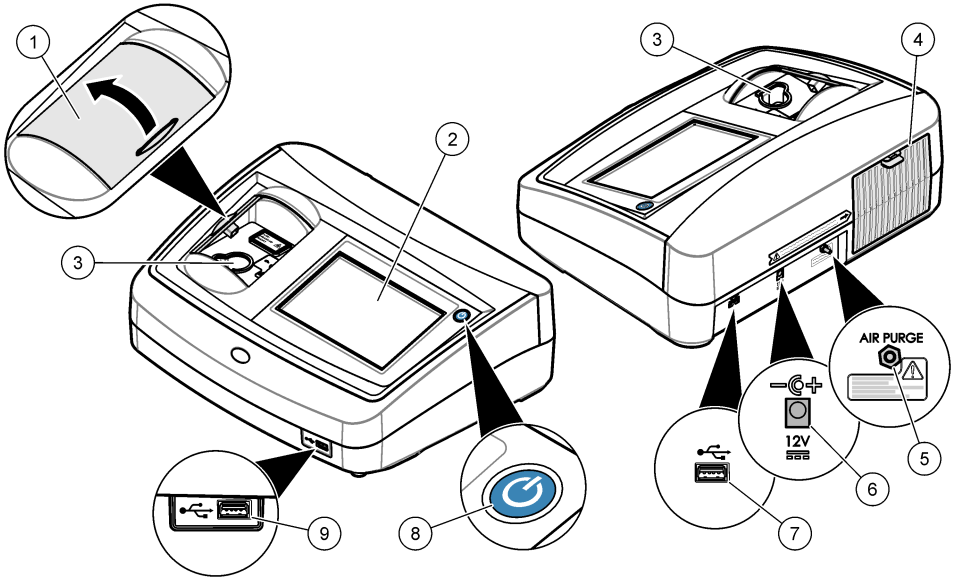

|                          |                    |
|--------------------------|--------------------|
| 1 Sample compartment lid | 6 Power connection |
| 2 Touch screen display   | 7 USB port         |
| 3 Sample cell holder     | 8 Power button     |
| 4 Lamp cover             | 9 USB port         |
| 5 Air purge              |                    |

### 2.3 Product components

Make sure that all components have been received. Refer to [Figure 2](#). If any items are missing or damaged, contact the manufacturer or a sales representative immediately.

**Figure 2 Instrument components**

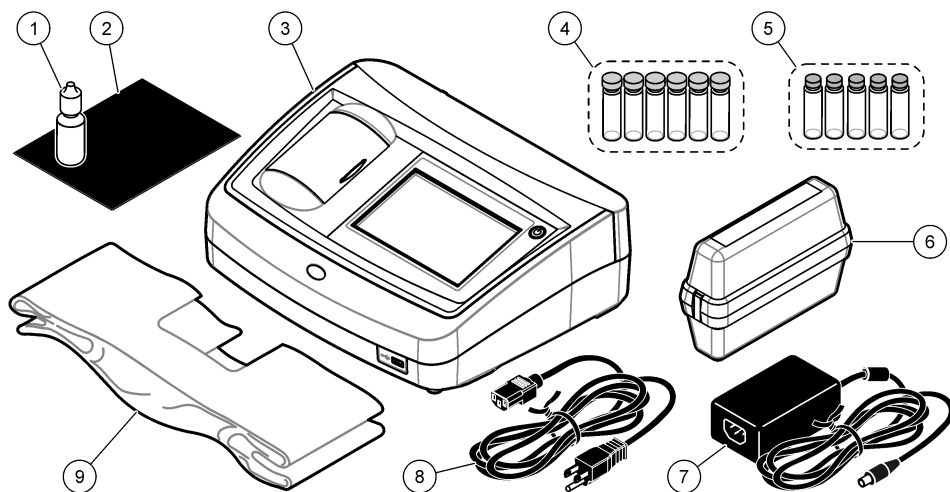

|   |                            |
|---|----------------------------|
| 1 Silicone oil                                  | 6 StablCal Calibration kit |
| 2 Oiling cloth                                  | 7 Power supply             |
| 3 TL2310 turbidimeter                           | 8 Power cord               |
| 4 1-inch sample cells (30 mL) with caps (6x)    | 9 Dust cover               |
| 5 Gelex secondary turbidity standardization kit |                            |

## Section 3 Installation

### ⚠ CAUTION



Multiple hazards. Only qualified personnel must conduct the tasks described in this section of the document.

This instrument is rated for an altitude of 3100 m (10,710 ft) maximum. Use of this instrument at an altitude higher than 3100 m can slightly increase the potential for the electrical insulation to break down, which can result in an electric shock hazard. The manufacturer recommends that users with concerns contact technical support.

### 3.1 Installation guidelines

Install the instrument:

- On a level surface
- In a clean, dry, well ventilated, temperature controlled location
- In a location with minimum vibrations that has no direct exposure to sunlight
- In a location where there is sufficient clearance around it to make connections and to do maintenance tasks
- In a location where the power button and power cord are visible and easily accessible

### 3.2 Connect to external devices (optional)

Use the USB ports to connect the instrument to a Seiko DPU-S445 printer, barcode handset scanner, USB flash drive or keyboard. Refer to [Figure 1](#) on page 7. The maximum length of a

connected USB cable is 3 m (9.8 ft). As an alternative to the touchscreen, use a keyboard to enter text into text boxes on the display (e.g., passwords and sample IDs).

## Section 4 Startup

### ▲ CAUTION

**Infrared Light Hazard.** The infrared light produced by this instrument can cause eye injury. The infrared light source in this instrument only receives power when the sample cell cover is closed.

Refer to the illustrated steps that follow to supply power to the instrument and start the instrument. The self-check will start.

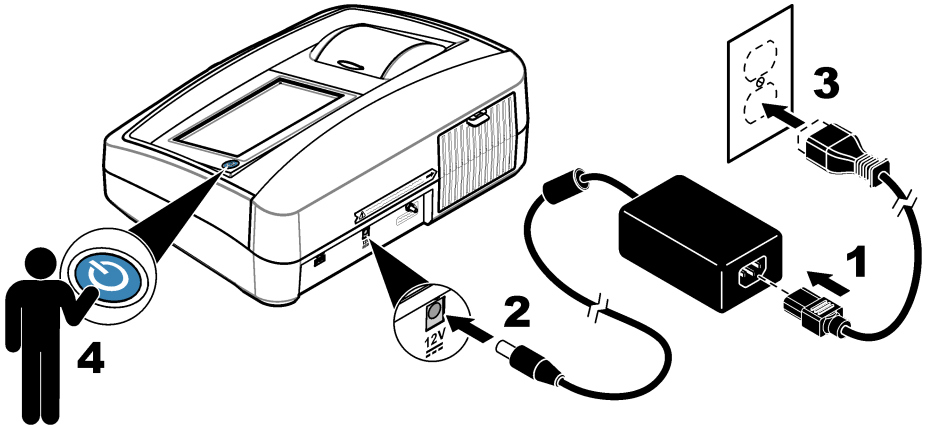

## Section 5 User interface and navigation

The instrument display is a touch screen. Only use a clean, dry finger tip to navigate the functions of the touch screen. Do not use writing tips of pens or pencils or other sharp objects to make selections on the screen or damage to the screen will occur.



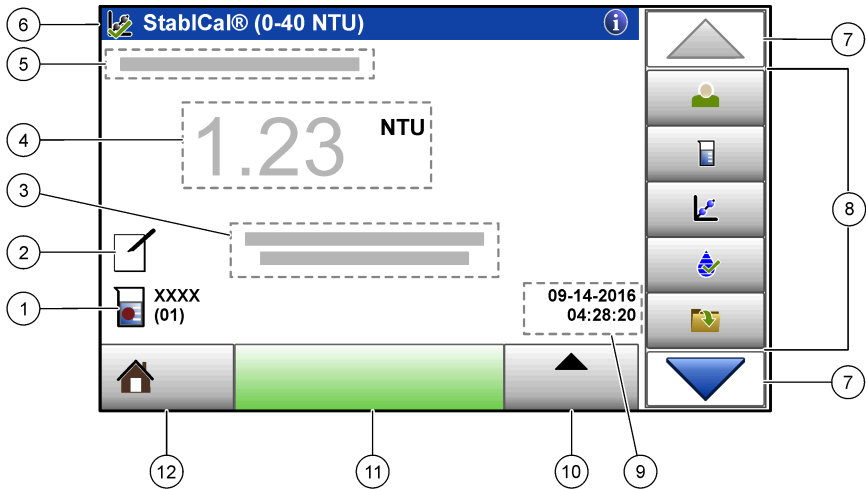

Refer to [Figure 3](#) for an overview of the home screen.

**Figure 3 Display overview**







|   |                                       |
|---|---------------------------------------|
| 1 Sample ID and measurement number <sup>4</sup> | 7 UP/DOWN navigation arrows           |
| 2 User comments                                 | 8 Sidebar menu (refer to Table 1)     |
| 3 Instructions                                  | 9 Time and date                       |
| 4 Turbidity value, unit and reading mode        | 10 Options button                     |
| 5 Warning or error message                      | 11 Read button                        |
| 6 Calibration status icon and calibration curve | 12 Home/Instrument information button |

**Table 1 Sidebar menu icons**

| Icon  | Description  |
|---|--|
| <br>Login          | Logs in or logs out an operator. To log in, select an operator ID and then push <b>Login</b> . To log out, push <b>Logout</b> .<br><i>Note: When an operator is logged in, the Login icon changes to the icon selected for the operator ID (e.g., fish, butterfly or soccer ball) and the text "Login" changes to the operator ID.</i> |
| <br>Sample ID    | Selects the sample ID.   |
| <br>Calibration  | Starts a calibration.  |
| <br>Verification | Starts a verification.   |

<sup>4</sup> The measurement number increases by one each time a measurement is completed.

**Table 1 Sidebar menu icons (continued)**

| Icon   | Description  |
|--|--|
| <br>Data Log    | Shows the reading log, calibration log and verification log. Refer to <a href="#">Show the recorded data</a> on page 23. |
| <br>Setup       | Configures the instrument settings. Refer to <a href="#">Configure the instrument settings</a> on page 11.               |
| <br>Diagnostics | Shows the firmware information, instrument backup, instrument updates, signaling information and factory service data.   |
| <br>Timer       | Sets a timer.  |

## Section 6 Operation

### 6.1 Configure the instrument settings

1. Push , then push **Setup**.
2. Select an option.

| Option                 | Description   |
|------------------------|---|
| <b>Location</b>        | Sets the location name of the instrument. The location is sent with measurements to the USB drive. The location is not saved to the data log.   |
| <b>Date &amp; Time</b> | Sets the date format, the time format and the date and time. Enter the current date and time. <b>Date Format</b> —Sets the date format. Options: dd-mm-yyyy (default), yyyy-mm-dd, dd-mm-yyyy or mm-dd-yyyy. <b>Time Format</b> —Sets the time format. Options: 12 or 24 hours (default).   |
| <b>Security</b>        | <p>Enables or disables password protection for the settings and tasks in the security list. <b>Security Password</b>—Sets or changes the security (administrator) password (10 characters maximum). Passwords are case sensitive. <b>Security List</b>—Sets the security level for each setting and task in the security list.</p> <ul style="list-style-type: none"> <li>• <b>Off</b>—All operators can change the setting or do the task.</li> <li>• <b>One key</b>—Only operators with a one-key or two-key security level can change the setting or do the task. Refer to <a href="#">Add operator IDs</a> on page 12.</li> <li>• <b>Two keys</b>—Only operators with a two-key security level can change the setting or do the task.</li> </ul> <p><i>Note: The Security setting is not set to on until Close is pushed.</i></p> |
| <b>Sound Settings</b>  | Enables or disables the sound settings for individual events. To enable or disable all of the sound settings, select All and then push <b>Setup</b> .   |

| Option                  | Description  |
|-------------------------|--|
| <b>Peripherals</b>      | Shows the connection status of attached devices such as a Seiko DPU-S445 printer, USB memory (flash drive) or keyboard.  |
| <b>Power Management</b> | Sets when the instrument is automatically set to sleep mode or off after a period of no activity. <b>Sleep Timer</b> —Sets when the instrument is set to sleep mode. Options: OFF, 30 minutes, 1 (default), 2 or 12 hours. |

### 6.1.1 Configure the measurement settings

Select the reading mode, measurement units, data log settings and more.

1. At the main reading screen, push **Options>Reading Setup**.
2. Select an option.

| Option                | Description   |
|-----------------------|---|
| <b>Reading Mode</b>   | Sets the reading mode to single, continuous or RST mode. <b>Single (default)</b> —The measurement stops when the reading is stable. <b>Continuous</b> —The measurement continues until the user pushes <b>Done</b> . <b>RST</b> —The Rapidly Settling Turbidity (RST) mode calculates and continuously updates the turbidity reading of the sample to a confidence of 95%, based on the accumulated trend of the real time measured values. The RST mode is best used on samples that settle rapidly and continuously change in value. The reading is based on a correctly prepared sample that is homogeneous at the beginning of the reading. It is best applied to samples that are greater than 20 NTU. The sample must be mixed thoroughly by inversion immediately before inserting it into the instrument. <b>Signal Avg</b> —The turbidity reading that shows on the display is an average of the values measured during the time interval selected. Options: For single measurement mode, 5 to 15 seconds. For continuous measurement mode, 5 to 90 seconds. |
| <b>Unit</b>           | Selects the measurement units that show on the display and that are recorded to the data log. Options: NTU (default), FNU.  |
| <b>Bubble Reject</b>  | Sets the bubble reject to on (default) or off. When set to on, high turbidity readings caused by bubbles in the sample are not shown or saved to the data log.  |
| <b>Data Log Setup</b> | Sets the data log settings. <b>Auto Store</b> —Measurement data is automatically recorded in the reading log. Default: On. If Auto Store is off, push Options>Store to manually save a reading in the data log. <b>Send Data Format</b> —Sets the output format of measurement data that is sent to external devices (CSV, XML or BMP). Default: XML. <b>Print Format</b> —Sets the output format of measurement data that is sent to a printer (Quick Print or Detailed Print (GLP)). <b>Comments</b> —Lets users add comments to log entries. <b>Auto Send</b> —Measurement data is automatically sent to all of the devices (e.g., printer and USB flash drive) that are connected to the instrument after each measurement. Options: Off, new file or continue file: off—do not auto send data, new file—send data and save it in a new file, continue file—send data and save all data in one file.  |

### 6.1.2 Add operator IDs

Add a unique operator ID for each person who will measure samples (30 maximum). Select an icon, operator password and security level for each operator ID.

1. Push **Login**.
2. Push **Options>New**.
3. Enter a new operator ID (20 characters maximum), then push **OK**.
4. Push the **LEFT** and **RIGHT** arrows to select the icon for the operator ID (e.g., fish, butterfly or soccer ball).

5. Push **Operator Password**, then enter a password for the operator ID.

*Note: Passwords are case sensitive.*

6. Push **Security Level**, then select the security level for the operator ID.

- **Off**—The operator cannot change the settings or do the tasks in the Security settings that have a security level of one key or two keys.
- **One key**—The operator can change all the settings and do all the tasks in the Security settings that have a security level of off or one key.
- **Two keys**—The operator can change all the settings and do all the tasks in the Security settings.

*Note: Before a security level can be selected, the Security setting must be set to on. Refer to [Configure the instrument settings](#) on page 11.*

7. Push **OK>Close**.

8. To edit an operator ID, select the operator ID and then push **Options>Edit**.

9. To delete an operator ID, select the operator ID and then push **Options>Delete>OK**.

### 6.1.3 Add sample IDs

Add a unique sample ID for each sample (1000 maximum). The sample ID identifies the sample location or other sample specific information.

As an alternative, import sample IDs from a spreadsheet file to the instrument. Refer to [Import sample IDs \(optional\)](#) on page 13.

1. Push **Sample ID**.

2. Push **Options>New**.

3. Enter a new sample ID (20 characters maximum).

4. Push **OK**.

5. Select an option.

| Option               | Description  |
|----------------------|--|
| <b>Add Date/Time</b> | Adds the date and time that the sample was collected to the sample ID (optional). The date and time entered for each sample ID show on the Sample ID menu.   |
| <b>Add Number</b>    | Adds a measurement number to the sample ID (optional). Select the first number used for the measurement number (0 to 999). The measurement number shows in parenthesis after the sample ID on the home screen. Refer to <a href="#">User interface and navigation</a> on page 9. |
| <b>Add Color</b>     | Adds a colored circle to the sample ID icon (optional). The sample ID icon shows before the sample ID on the home screen. Refer to <a href="#">User interface and navigation</a> on page 9.  |

6. Push **OK>Close**.

7. To edit a sample ID, select the sample ID and then push **Options>Edit>OK**.

8. To delete a sample ID, select the sample ID and then push **Options>Delete>OK**.

*Note: To delete all sample ID's, select the sample ID and then push **Options>Delete All Sample IDs>OK**.*

#### 6.1.3.1 Import sample IDs (optional)

Import sample IDs from a spreadsheet file on a USB flash drive.

*Note: Imported sample IDs cannot be edited.*

1. On a PC, make a new spreadsheet file.

2. At the top of the first column, enter #Reading Number,#Sample ID,#Date and Time for the heading.

3. Enter the information for one sample ID in each row after the heading. Make sure that there are no spaces.

**Example:**

#Reading Number,#Sample ID,#Date and Time

0,Aeration,13.09.2016 10:03

0,Outlet,13.09.2016 06:30

0,Feed,13.09.2016 18:00

*Note: The date of sample collection is optional.*

4. Make a new folder on a USB flash drive. Give the folder the name "SampleID".
5. Save the spreadsheet file to the SampleID folder as a CSV (comma-separated value) or TXT (text) file.
6. Connect the USB flash drive to a USB port on the instrument.
7. On the instrument, push **Sample ID>Options>Import Sample ID list**.  
The filename of the spreadsheet file(s) in the SampleID folder shows.
8. Select the applicable spreadsheet file, then push **OK**.  
The sample IDs are added to the instrument.

## 6.2 Calibrate the turbidimeter with StabCal Standards

Calibrate the turbidimeter before it is used for the first time using the StabCal sealed vial standards provided.

Calibrate the turbidimeter at least every 3 months or as specified by the regulating authority when data is used for ISO 7027 reporting.

*Note: Unknown results may occur if standards other than the recommended calibration points are used. The recommended calibration points (< 0.1, 20, 200 and 1000 NTU) provide the best calibration accuracy. Use of standards other than StabCal, or user-prepared formazin, may result in less accurate calibrations. The manufacturer cannot guarantee the performance of the instrument if calibrated with co-polymer styrenedivinylbenzene beads or other suspensions.*

### 6.2.1 Calibration notes

- Make sure that the instrument is in the same ambient conditions as where it is used.
- Make sure that the standards are at the same ambient temperature as the instrument before use.
- Use only the provided silicone oil. This silicone oil has the same refractive index as the vial glass and masks minor glass differences and scratches.
- Store the oiling cloth in a plastic storage bag to keep the cloth clean.
- If power is lost during calibration, the new calibration data is lost and the last calibration data is used.
- In Calibration mode, automatic range and signal averaging on are selected. When calibration is completed, all operational modes go back to the last settings.
- All nephelometric (turbidity units of measure) calibrations are done at the same time.
- The FNU values of StabCal standards and formazin standards are calculated using the conversion factors of 1 FNU = 1 NTU.

### 6.2.2 Prepare the StabCal standards

When received and at intervals:

1. Clean the exterior surface of the StabCal vials with laboratory glass cleaning detergent.
2. Rinse the vials with distilled or deionized water.
3. Dry the vials with a lint-free cloth.

*Note: Never shake or invert the < 0.1 NTU standard. If the standard has been mixed or shaken, do not move the vial for 15 minutes or more before using.*

*Note: Do not remove the caps from the sealed vials.*



Make sure that the StablCal standards are at ambient instrument temperature before use (and no greater than 40 °C (104 °F)).

Invert the standards (except < 0.1 NTU) before use. Refer to the user instructions that are supplied with the StablCal standards.

### 6.2.3 Configure the calibration settings

Change the calibration settings as necessary before the instrument is calibrated. The instrument must be calibrated when the calibration curve is changed.

1. Push **Calibration**.
2. Push **Options>Calibration Setup**.
3. Select the calibration curve range and type of calibration standard.

| Option                              | Description   |
|-------------------------------------|---|
| <b>StablCal RapidCal (0–40 NTU)</b> | Calibration with 20-NTU StablCal standard (default).<br><i>Note: The dark current in the instrument is used as the zero point of the calibration curve. The calibration curve is linear from 0-40 NTU, thus low turbidity measurements are very accurate.</i> |
| <b>StablCal (0–1000 NTU)</b>        | Full-range calibration (<0.1 NTU, 20 NTU, 200 NTU, 1000 NTU) with StablCal.   |
| <b>Formazin RapidCal (0–40 NTU)</b> | Calibration with 20-NTU formazin standard.<br><i>Note: The dark current in the instrument is used as the zero point of the calibration curve. The calibration curve is linear from 0-40 NTU, thus low turbidity measurements are very accurate.</i>           |
| <b>Formazin (0–1000 NTU)</b>        | Full-range calibration (20 NTU, 200 NTU, 1000 NTU and dilution water) with formazin.  |
| <b>SDVB (0–1000 NTU)</b>            | Full-range calibration (20 NTU, 200 NTU, 1000 NTU and dilution water) with spherical styrene divinylbenzene.  |
| <b>EU Pharm (0–30 NTU)</b>          | Full-range calibration (<0.1 NTU, 3 NTU, 6 NTU, 18 NTU, 30 NTU).  |

4. Select the remaining calibration options.

| Option                              | Description   |
|-------------------------------------|---|
| <b>Verify after Cal.</b>            | Sets the instrument to start a verification immediately after the instrument is calibrated. When set to on, the verification standard is measured immediately after a calibration is done. The value of the verification standard shows on the display as the last standard during calibration.             |
| <b>Calibration Reminder</b>         | Sets the time interval between calibrations. When a calibration is due, the display will show a reminder and a question mark on the calibration icon at the top of the display. Options: Off (default), 1 day, 7 days, 30 days or 90 days. When a calibration is done, the calibration time is set to zero. |
| <b>Reset to Factory Calibration</b> | Sets the calibration settings to the factory defaults.  |

## 6.2.4 StabiCal calibration procedure

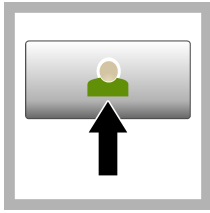

1. Push **Login** and select the applicable Operator ID. If login is not necessary, go to step 3.

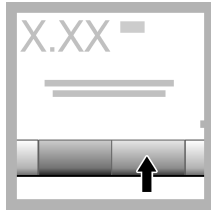

2. Push **Login** and enter the password. Push **OK**.

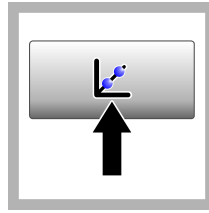

3. Push **Calibration**. The standard values for the selected calibration curve (and verification standard, if Verify after Cal is on) show on the display. To select a different calibration curve, refer to [Configure the calibration settings](#) on page 15.



4. Get the StabiCal standard that shows on the display. Clean the vial with a soft, lint-free cloth to remove water spots and fingerprints.



5. Apply a small drop of silicone oil from the top to the bottom of the vial.



6. Use the oiling cloth to apply the oil equally to the surface of the vial. Remove most of the oil. Make sure that the vial is almost dry.

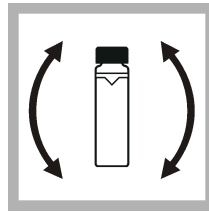

7. Carefully and slowly invert the vial to fully mix the standard (do not invert the <0.1 NTU vial). Be careful not to add air bubbles.

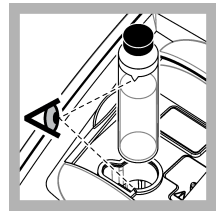

8. Put the vial in the sample cell holder with the triangle on the vial aligned with the reference mark on the sample cell holder. Push the lid closed until a click is heard.

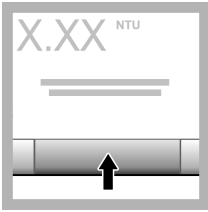

**9. Push Read.** Wait 1 minute for the instrument to complete the measurement.

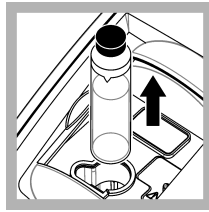

**10. Open the lid and remove the vial from the sample cell holder.**

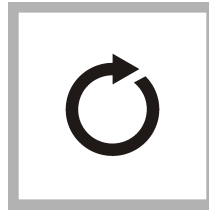

**11. Do steps 4–10 for the other StablCal vials (from lowest to highest NTU standard). When complete, the measured values are shown.**

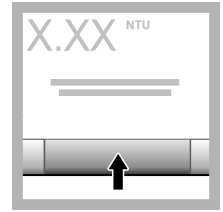

**12. If Verify after Cal is set to on, the value of the verification standard shows. Push Read to measure the verification standard.**

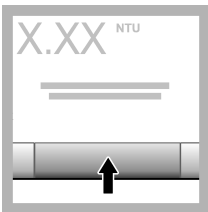

**13. Push Store** to save the new calibration data.

## 6.2.5 StablCal standards storage

- Do not move a StablCal standard to a different container for storage. Keep StablCal standards in the plastic case provided with the cover closed.
- Store at 5 to 25 °C (41 to 77 °F).
- For long-term storage (more than one month between use), keep at 5 °C (41 °F).

## 6.3 Calibration verification

At intervals, measure the Gelex secondary turbidity standard that is closest in value to the turbidity range to be measured. Do the steps in [Measure the Gelex secondary turbidity standards](#) on page 18, but do not change the value that is recorded on the vial.

If the measured value is within  $\pm 5\%$  of the value recorded on the Gelex vial, calibration is verified. If not, calibrate the instrument.

**Note:** The StablCal primary turbidity standards can also be used to do a calibration check. Prepare the StablCal vials before use. Refer to [Prepare the StablCal standards](#) on page 14. Do not use the < 0.1 NTU StablCal vial as it does not have an accurately identified NTU value. The instrument is calibrated if the measured value is within  $\pm 5\%$  of the StablCal value.

### 6.3.1 Optical system check

Measure the Gelex stray light standard when the instrument is first received. Record the value on the Gelex vial with a permanent marker one time.

At intervals, measure the Gelex stray light standard to inspect the integrity of the optical system. Do not change the value that is recorded on the vial.

If the value measured is similar to the value recorded on the Gelex stray light standard (within  $\pm 0.02$  NTU), the instrument works correctly. If not, contact Customer Service.

### 6.3.2 Configure the verification settings

Select the acceptance range and measurement units for calibration verification and more.

1. Push **Verification**.
2. Push **Options>Verification Setup**.
3. Select an option.

| Option                       | Description   |
|------------------------------|---|
| <b>Secondary Standard</b>    | Sets the value of the verification standard. Enter the value of the Gelex vial or StablCal standard to be used for verification.  |
| <b>Verify after Cal.</b>     | Sets the instrument to start a verification immediately after the instrument is calibrated. When set to on, the verification standard is measured immediately after a calibration is done.  |
| <b>Acceptance Range</b>      | <b>Value</b> —Sets the maximum difference permitted between the recorded value of the verification standard and the measured value of the verification standard during verification. <b>Unit</b> —Sets the acceptance range for verification to a percentage (1 to 20%) or an NTU value (0.001 to 20% of the maximum range limit). Options: % or NTU. |
| <b>Verification Reminder</b> | Sets the time interval between calibration verifications. The display will show a reminder when a verification is due. Options: OFF(default), 1 day, 7 days, 30 days or 90 days. When a verification is done, the verification time is set to zero.   |

### 6.3.3 Gelex notes

- Measure the Gelex secondary standards on the instrument on which they will be used. The measured values can only be used for one instrument due to small differences in glass and instrument optical systems.
- Do not keep a Gelex vial in the instrument for more time than is necessary to complete measurement. The heat from the lamp can change the turbidity value of a Gelex vial.
- Keep the Gelex standards at room temperature. Do not let Gelex standards freeze or become warmer than 50 °C (122 °F). High temperatures may cause Gelex suspensions to divide.
- Make sure that the Gelex standards are at ambient instrument temperature before measurement.

### 6.3.4 Measure the Gelex secondary turbidity standards

**Pre-requisites:** Make sure that the units show NTU and Signal Avg is not selected. Refer to [Configure the measurement settings](#) on page 12.

Measure the Gelex secondary turbidity standards each time the instrument is calibrated and record the new values on the Gelex vials with a water soluble marker.



1. Clean the Gelex vials with a soft, lint-free cloth to remove water spots and fingerprints.



2. Apply a small drop of silicone oil from the top to the bottom of the vial.



3. Use the oiling cloth to apply the oil equally to the surface of the vial. Remove most of the oil. Make sure that the vial is almost dry.

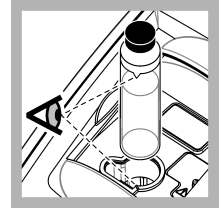

4. Put the 0–2 NTU Gelex vial in the sample cell holder with the triangle on the vial aligned with the reference mark on the sample cell holder. Push the lid closed until a click is heard.



5. When the value is stable, push **Read**.

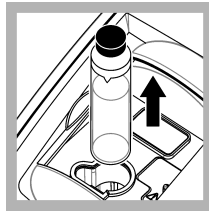

6. Open the lid and remove the vial from the instrument.

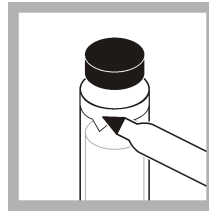

7. Record the value on the white diamond space on the vial using a water soluble marker.

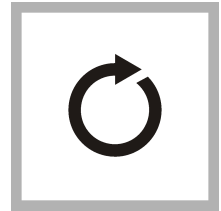

8. Do all steps again for the other Gelex vials (but not the stray light standard). Measure from lowest to highest NTU.

### 6.3.5 Verification procedure

Use the verification procedure to measure the same Gelex or StablCal vial at regular intervals to determine if the reading stays within the acceptance range. Use the Verification Setup menu to set a reminder for the verification.

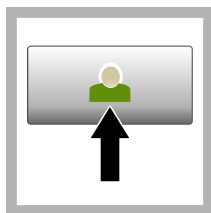

1. Push **Login** and select the applicable Operator ID. If login is not necessary, go to step 3.

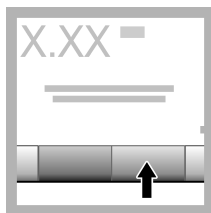

2. Push **Login** and enter the password. Push **OK**.

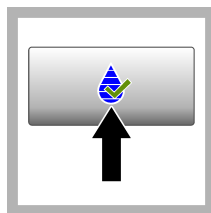

3. Push **Verification**. The verification standard value is shown. Push **Options>Verification Setup** to change the value of the verification standard.



4. Clean the Gelex vials with a soft, lint-free cloth to remove water spots and fingerprints.



5. Apply a small drop of silicone oil from the top to the bottom of the vial.



6. Use the oiling cloth to apply the oil equally to the surface of the vial. Remove most of the oil. Make sure that the vial is almost dry.

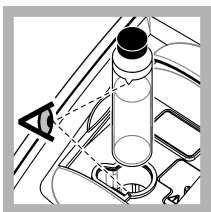

7. Put the vial in the sample cell holder with the triangle on the vial aligned with the reference mark on the sample cell holder. Push the lid closed until a click is heard.

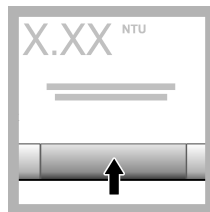

8. Push **Read**. The value and pass or fail status shows. The data is automatically stored in the instrument.

## 6.4 Turbidity measurement

For accurate turbidity readings use clean sample cells and remove air bubbles. Refer to [Clean the sample cell](#) on page 21 and [Remove air bubbles from the sample](#) on page 30.

### 6.4.1 Measurement notes

Proper measurement techniques are important in minimizing the effects of instrument variation, stray light and air bubbles. For accurate and repeatable measurements:

#### Instrument

- Make sure that the instrument is on a level, stationary surface that is free of vibration during the measurement.
- Instrument stabilization is immediate. No warm-up time is necessary.
- Always close the sample compartment lid during measurement, calibration and verification.
- Remove the sample cell from the instrument and turn off the instrument if the instrument is stored for an extended time period (more than a month).
- Keep the sample compartment lid closed to keep dust and dirt out.

#### Sample cells

- Always cap the sample cell to prevent spillage of the sample into the instrument.

- Always use clean sample cells in good condition. Dirty, scratched or damaged cells can result in readings that are not accurate.
- Make sure that cold samples do not “fog” the sample cell. Refer to [Prevent condensation on a sample cell](#) on page 30.
- Store sample cells filled with distilled or deionized water and cap tightly.
- For the best accuracy, use a single sample cell for every measurement or a flow cell.

**Note:** As an alternative, matched sample cells may be used for measurements but do not provide as good of accuracy or precision as a single indexed sample cell or flow cell. When using matched sample cells, align the orientation mark on the sample cell with the reference mark on the sample cell holder.

## Measurement

- Measure samples immediately to prevent temperature changes and settling. Before a measurement is taken, always make sure that the sample is homogeneous throughout.
- Avoid sample dilution when possible.
- Avoid instrument operation in direct sunlight.

### 6.4.2 Sample collection

- Collect samples in clean glass or plastic bottles with tight-fitting caps.
- Rinse the container a minimum of three times with the sample.
- When collecting a sample from a water tap in a distribution system or treatment plant, turn the water on for at least five minutes, then collect the sample. Do not adjust the flow because this can add particles.
- When collecting a sample from a body of water (e.g., a stream or storage tank), collect at least one liter (1 quart) and fully mix before taking an aliquot for measurement. If the quality of the sample source is not constant, collect samples at many locations at different depths as necessary. Then, mix the samples together to prepare one sample for measurement.
- Fill the container. Let the container overflow with the sample and then immediately put the cap on the sample container so that there is no headspace (air) above the sample.
- Write the sample information on the container.
- Start analysis as soon as possible to prevent temperature changes, bacteria growth and settling.

### 6.4.3 Clean the sample cell

#### ▲ CAUTION



Chemical exposure hazard. Obey laboratory safety procedures and wear all of the personal protective equipment appropriate to the chemicals that are handled. Refer to the current safety data sheets (MSDS/SDS) for safety protocols.

#### NOTICE

Do not air dry the sample cells. Always store the sample cells with caps on to prevent the cells from drying. For storage, fill the sample cell with distilled or demineralized water.

1. Clean the internal and external surfaces of the sample cell and cap with a laboratory glass cleaning detergent.
2. Clean the internal and external surfaces of the sample cell and cap with 1:1 hydrochloric acid.
3. Fully rinse the sample cell many times with distilled or deionized water.

**Note:** If the sample cell will be used to measure low range turbidity samples or dilution water, rinse with dilution water (not distilled or deionized water). Refer to [Prepare dilution water](#) on page 27.

4. Dry the external surface of the sample cell with a soft, lint-free cloth.
5. Fill the sample cell with distilled or deionized water.

**Note:** If the sample cell will be used to measure low range turbidity samples or dilution water, fill the sample cell with dilution water (not distilled or deionized water).

6. Immediately put the cap on the sample cell.

**Note:** Hold the sample cell by the top only to minimize dirt and fingerprints.

### 6.4.4 Turbidity measurement procedure

To include an operator ID and sample ID with the measurement data, refer to [Add sample IDs](#) on page 13 and [Add operator IDs](#) on page 12.

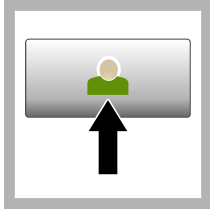

1. Push **Login** and select the applicable Operator ID. If login is not necessary, go to step 3.

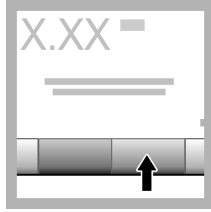

2. Push **Login** and enter the password. Push **OK**.

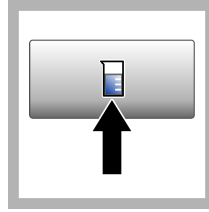

3. Push **Sample ID**. Select the applicable sample ID, then push **Select**. The selected sample ID shows on the display.



4. Rinse a clean, empty sample cell two times with the solution to be measured and drain to waste. Fill to the line (about 30 mL) with sample and immediately put the cap on the sample cell.



5. Clean the sample cells with a soft, lint-free cloth to remove water spots and fingerprints.



6. Apply a small bead of silicone oil from the top to the bottom of the sample cells.

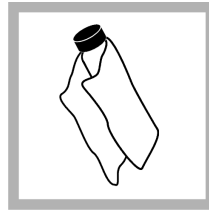

7. Use the oiling cloth provided to apply the oil equally to the surface of the sample cells. Remove the excess oil. Make sure that the sample cells are almost dry.

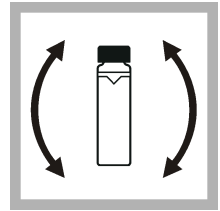

8. Gently and slowly invert the sample cell to fully mix the sample. Be careful not to add air bubbles.



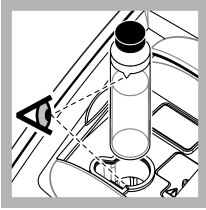

9. Put the sample cell in the sample cell holder with the triangle on the sample cell aligned with the reference mark on the sample cell holder. Push the lid closed until a click is heard.

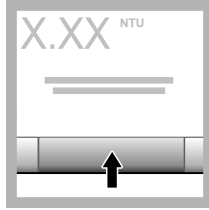

10. Push **Read** (or **Done** if in continuous mode). Wait for the instrument to read the sample.

**Note:** If auto store is off, push **Options > Store** to save the data.

## 6.5 Data management

### 6.5.1 Show the recorded data

All the recorded data is kept in the data log. There are three types of data logs:

- **Reading log**—Shows the recorded measurements.
- **Calibration log**—Shows the calibration history.
- **Verification log**—Shows the verification history.

1. Push **Data Log** and select the applicable data log.
2. To show the details of a log entry, select the log entry and then push **View Details**.  
**Note:** To add a comment to the log entry, push the comments icon.
3. To show only some of the data, push **Filter**, then select On. The Filter Settings window opens.
4. Select an option.

| Option               | Description   |
|----------------------|---|
| <b>Time Interval</b> | Selects only the data that was stored during a specific time interval.                |
| <b>Operator ID</b>   | Selects only the data that was stored with a specific operator ID.                    |
| <b>Sample ID</b>     | Selects only the data from the Reading Log that was stored with a specific sample ID. |

### 6.5.2 Send data to a connected device

The instrument can send data to a USB memory device or Seiko DPU-S445 printer. For best results, use only USB 2.0 memory devices. The instrument makes a logger folder on the device and saves the data as a .bmp, .csv or .xml file.

1. Connect a USB memory device or cable to a USB port on the instrument.
2. Connect the other end of the cable to the printer, if applicable. Refer to [Figure 4](#).
3. Go to **Setup>Peripherals**. The connection status shows Connected. If the status shows Not Connected, make sure to use the recommended devices.
4. Push **Data Log** and select the applicable log.

5. To send only some of the data, use the filter settings or select a single data point. Refer to [Show the recorded data](#) on page 23.
6. Push **Options>Send Data Log**. Select single data point, filtered data or all data. Push **OK**. The instrument sends the selected data to the connected devices.

**Figure 4 Connect the printer to the instrument**

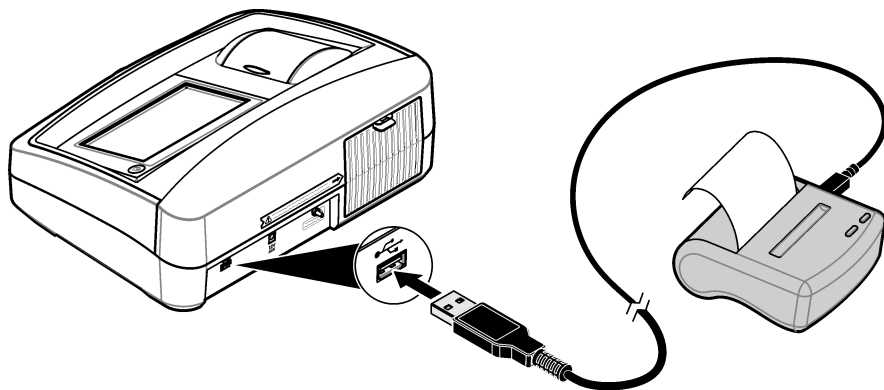

### 6.5.3 Delete data from the data log

The instrument automatically deletes the oldest data record when the data log is full. The user can also delete data manually. Make sure to save the data to an external device, then delete the data in the data log.

1. Push **Data Log** and select the applicable log.
2. To delete only some of the data, use the filter settings. Refer to [Show the recorded data](#) on page 23.
3. To delete the data, push **Options>Delete Data**. Select single data point, filtered data or all data. Push **OK**.  
The instrument deletes the selected data from the data log.

### 6.5.4 Backup the instrument settings

Save instrument settings such as Operator ID to a USB memory device, then install the settings on a different instrument of the same model.

1. Install a USB memory device in the USB port on the instrument.
2. Push **Settings>Instrument Backup**. Push **OK**. The settings are saved to the USB memory device.

## 6.6 Measurement techniques

Measurements may be made with different operation mode settings and optional accessories. Calibrate the instrument whenever the sample cell pathlength is changed.

### 6.6.1 Indexing a single sample cell

When measuring very low turbidity samples, use a single indexed sample cell or a flow cell for all measurements to get precise and repeatable measurements. As an alternative, optically matched sample cells can be used. Refer to [Matching sample cells](#) on page 26. Matched sample cells do not provide as good of accuracy and precision as a single indexed sample cell that is used for every measurement or a flow cell.



**1.** Rinse a clean, empty sample cell two times with dilution water and drain to waste. Fill the sample cell to the line (about 30 mL) with dilution water and immediately put the cap on the sample cell. Refer to [Prepare dilution water](#) on page 27.

Let the sample cell sit for at least five minutes to degas.



**2.** Clean the sample cell with a soft, lint-free cloth to remove water spots and fingerprints.



**3.** Apply a small bead of silicone oil from the top to the bottom of the sample cell.



**4.** Use the oiling cloth provided to apply the oil equally to the surface of the sample cell. Remove the excess oil. Make sure that the sample cell is almost dry.

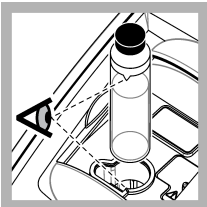

**5.** Put the sample cell in the sample cell holder. Push the lid closed until a click is heard.

Record the value when stable.

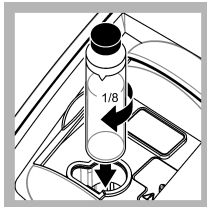

**6.** Remove the sample cell, turn it about  $\frac{1}{8}$  of a turn and put it in the sample cell holder again. Push the lid closed until a click is heard.

Record the value when stable.

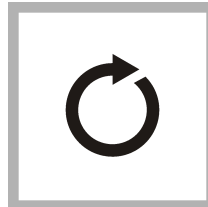

**7.** Repeat step **6** until the lowest value is shown on the display.

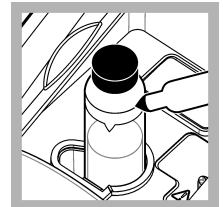

**8.** Put an orientation mark on the marking band near the top of the sample cell where the lowest value is shown.

## 6.6.2 Matching sample cells

To decrease the effects that optical differences among sample cells can have on turbidity measurements, measure samples in matched sample cells. It may not be possible to match all sample cells due to the differences in glass.

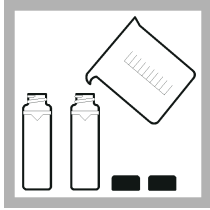

**1.** Rinse two or more clean, empty sample cells two times with dilution water and drain to waste. Fill the sample cells to the line (about 30 mL) with filtered dilution water and immediately put the cap on the sample cell. Refer to [Prepare dilution water](#) on page 27.

Let the sample cell sit for at least five minutes to degas.



**2.** Clean the sample cells with a soft, lint-free cloth to remove water spots and fingerprints. Do not invert the sample cell.



**3.** Apply a small bead of silicone oil from the top to the bottom of the sample cells.



**4.** Use the oiling cloth provided to apply the oil equally to the surface of the sample cells. Remove the excess oil. Make sure that the sample cells are almost dry.

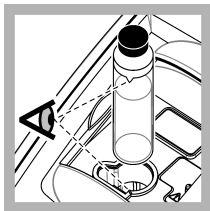

**5.** Put the first sample cell in the sample cell holder. Push the lid closed until a click is heard. Record the value when stable.

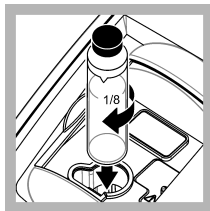

**6.** Remove the sample cell, turn it about  $\frac{1}{8}$  of a turn and put it in the sample cell holder again. Push the lid closed until a click is heard.

Record the value when stable.

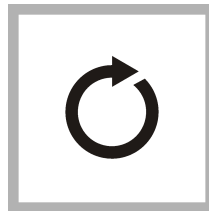

**7.** Repeat step 6 until the lowest value is shown on the display.

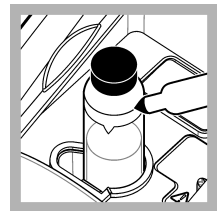

**8.** Record the value. Put an orientation mark on the marking band near the top of the sample cell.

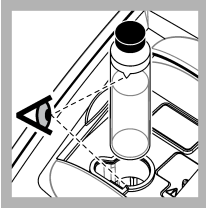

9. Put the second sample cell in the sample cell holder. Push the lid closed until a click is heard.

Record the value when stable.

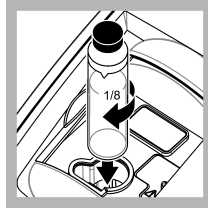

10. Remove the sample cell, turn it about  $\frac{1}{8}$  of a turn and put it in the sample cell holder again. Push the lid closed until a click is heard.

Record the value when stable.

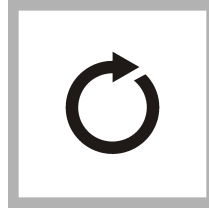

11. Repeat step 10 until the value matches the first sample cell value within  $\pm 0.005$  FNU.

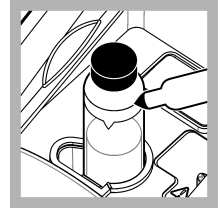

12. Put an orientation mark on the marking band near the top of the sample cell where the lowest value is shown.

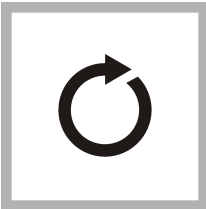

13. Do steps 9–12 again as necessary to match the other sample cells prepared in steps 1–4.

### 6.6.3 Prepare dilution water

Dilution water is used when indexing a sample cell or matching sample cells and to prepare formazin standards.

1. Collect at least 1000 mL of high-quality, low-turbidity water (i.e., distilled, demineralized or deionized water or filtered tap water).
2. Measure the turbidity of the water using the turbidimeter. Refer to [Turbidity measurement](#) on page 20.
3. If the turbidity of the water is greater than 0.5 NTU, filter the water using the sample filtration and degassing kit. Refer to the user instructions provided with the sample filtration and degassing kit.

### 6.6.4 Using a flow cell

#### ▲ CAUTION

Do not use a flow cell with flammable samples or those that contain hydrocarbons, solvents, concentrated acids or concentrated bases that may damage wetted parts of the cells. Conduct tests before use of flow cells if sample compatibility is not known.

**Note:** Do not use a high pressure flow cell kit with this instrument.

Use a flow cell to increase the speed, accuracy and reproducibility of measurement. The manufacturer especially recommends using a flow cell for low turbidity measurements. Refer to [Figure 5](#).

**Figure 5 Flow cell**

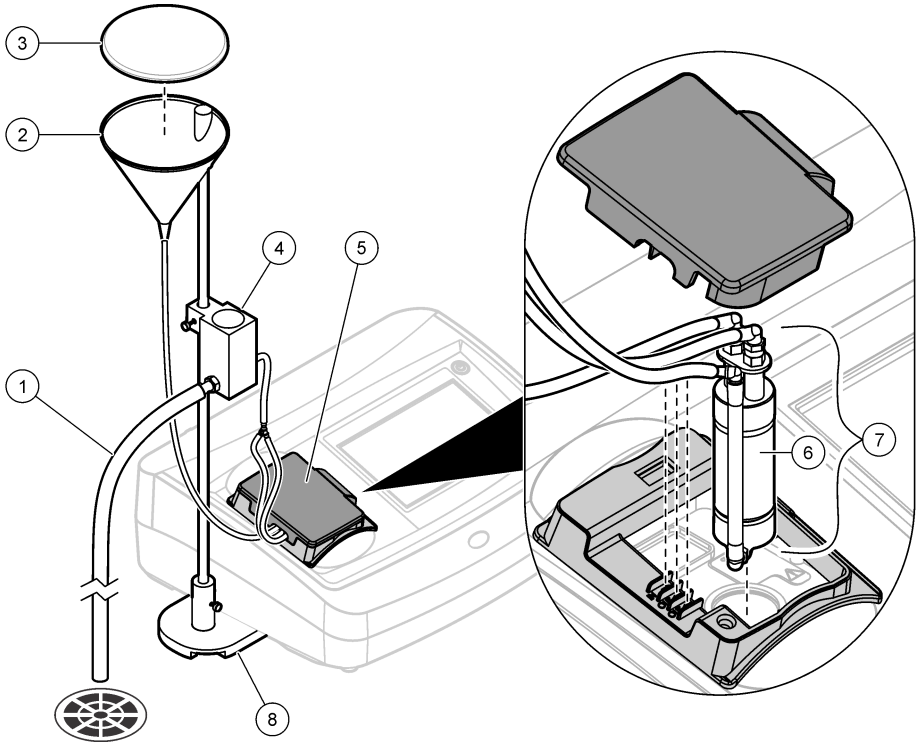

|                             |                      |
|-----------------------------|----------------------|
| 1 Drain tube                | 5 Flow cell cover    |
| 2 Inlet reservoir           | 6 Flow cell          |
| 3 Reservoir cover           | 7 Flow cell assembly |
| 4 Collection drain assembly | 8 Support stand base |

#### 6.6.4.1 Prepare the flow cell

1. Fully clean the flow cell. Refer to [Clean a flow cell assembly](#) on page 29.
2. Assemble the flow cell, tubing and stand. Refer to the user instructions that are supplied with the flow cell.
3. Fill the flow cell and tubing with water and make sure that there are no leaks or air bubbles.  
**Note:** *Air bubbles collect in areas that are not cleaned fully.*
4. Clean the exterior surface of the flow cell with a soft, lint-free cloth to remove water spots and fingerprints.
5. Apply a small bead of silicone oil from the top to the bottom of the flow cell.  
**Note:** *Use only the provided silicone oil. This silicone oil has the same refractive index as the flow cell glass and masks minor glass scratches.*

6. Use the oiling cloth provided to apply the oil equally to the surface of the flow cell. Remove the excess oil. Make sure that the flow cell is almost dry.

*Note: Put the oiling cloth in a plastic storage bag to keep the cloth clean.*

#### 6.6.4.2 Flow cell operation

- Do not use the flow cell for samples that contain large particles that may collect and stop the sample from flowing.
- Slowly pour the sample down the interior edge of the inlet reservoir to prevent mixing of the sample, which can cause air bubbles. Air bubbles create a false positive interference in a turbidity measurement.
- If bubbles collect in the flow cell, gently tap the flow cell on a soft surface to remove the bubbles. If bubbles continue to collect in the flow cell, put the glass flow cell in liquid detergent for 24 hours and then rinse fully.
- When measuring many samples of different turbidity, measure the samples in order of the cleanest (lowest turbidity) to the dirtiest (highest turbidity) to prevent contamination from one sample to the next.
- The flow-cell cover must be in place for the LED light source to function.

#### 6.6.4.3 Adjust the flow

To set the flow rate, increase the height of the collection drain assembly on the support rod to decrease the flow rate. Make sure that the bottom of the collection drain assembly is no lower than 7.5 cm (3 in.) above the support stand base.

To flush the flow cell, lower the collection drain assembly to the support stand base to flush the flow cell.

#### 6.6.4.4 Flow cell maintenance

- Keep all parts of the flow cell assembly clean.
- At intervals, replace all the tubing to make sure that the system is clean. Keep the tubing as short as possible to minimize air locking and lag time of sample flow. Locate the instrument as close to the drain as possible.

#### 6.6.4.5 Clean a flow cell assembly

1. Disassemble the flow cell assembly.
2. Clean the inside and outside of the glass parts with a laboratory glass cleaning detergent. Follow with multiple rinses with distilled or demineralized water.

*Note: All tubing, flow cells, and caps in the flow cell assembly can also be steam sterilized.*

3. If measuring low turbidity samples, clean the inside and outside of the glass parts with 1:1 hydrochloric acid and rinse multiple times with dilution water.
4. Fill the sample cell with distilled or demineralized water and immediately put the caps on the sample cell.

5. Clean the inside and outside of the plastic parts and tubing with laboratory detergent and warm water.

*Note: At intervals, replace the tubing as contaminants, including microbiological growths, are difficult to remove from the inside surface of the tubing.*

6. Air dry the parts after cleaning.

#### 6.6.4.6 Flow cell storage

- Install the reservoir cover when the system is not in use to prevent contamination of the system by airborne particles.
- For short-term storage (a few hours), flush the system with distilled or deionized water and leave the flow cell full of the flush water to minimize air locks and build up of residue on the parts.
- For long-term storage, disassemble, fully clean and air dry all parts.

### 6.6.5 Remove air bubbles from the sample

Air bubbles can cause unstable readings. Use a degassing method to remove air or other gases from the sample before measurement even if no bubbles are seen.

The methods typically used for degassing are:

- Let the sample stand for several minutes
- Apply a vacuum
- Use the sample degassing kit
- Use an ultrasonic bath

Let the samples stand for several minutes, then gently invert two or three times before measurement.

In some cases, more than one method may be necessary to remove bubbles (e.g., the use of heat with an ultrasonic bath may be necessary in some severe conditions). Use care with these methods as sample turbidity can be changed if these methods are not used correctly.

### 6.6.6 Prevent condensation on a sample cell

Condensation may occur on the outside of the sample cell when measuring a cold sample in a warm, humid environment. This condensation or fogging of the sample cell interferes with turbidity measurement.

To prevent condensation:

- Make sure that the outside of the sample cell is dry before measurement.
- Use the air purge system as necessary. Refer to [Using the air purge system](#) on page 30.
- If condensation occurs while using the air purge system, warm the sample slightly. Let the sample sit at room temperature or partially put the sample into a warm water bath for a short time. Gently invert the sample cell before measurement.

*Note: Warming may change the sample turbidity. Measure the sample without warming when possible.*

### 6.6.7 Using the air purge system

The air purge system is used to keep condensation off the external surface of the sample cell when cold samples are measured.

The air purge system pushes dry air through the optical compartment to keep the outside of the sample cell dry. The connection is made at the air purge fitting on the back of the instrument. Refer to [Product overview](#) on page 6.

Use dry nitrogen or instrument grade air (ANSI MC 11.1, 1975) at no greater than 138 kPa (20 psig). The manufacturer recommends an air consumption rate of 3 to 10 SCFH (standard cubic feet/hour).

When the sample temperature is about or less than 2 °C (35 °F), use a desiccant dryer and particle filter to make sure that the dew point of the air purge is less than the sample temperature. The air dryer must contain a desiccant with a color indicator. Replace the desiccant when the indicator changes color.

If only shop air is available, use a coalescing filter with an automatic drain and a dryer and particle filter to get instrument quality air. Use a coalescing filter that typically operates for greater than 2000 hours. Replace the particle filter when the air dryer is replaced.

[Figure 6](#) shows the methods for connecting the two types of air supply to the instrument.

*Note: The dryer and filter are not necessary if dry nitrogen is used.*



**Figure 6 Air purge connections**

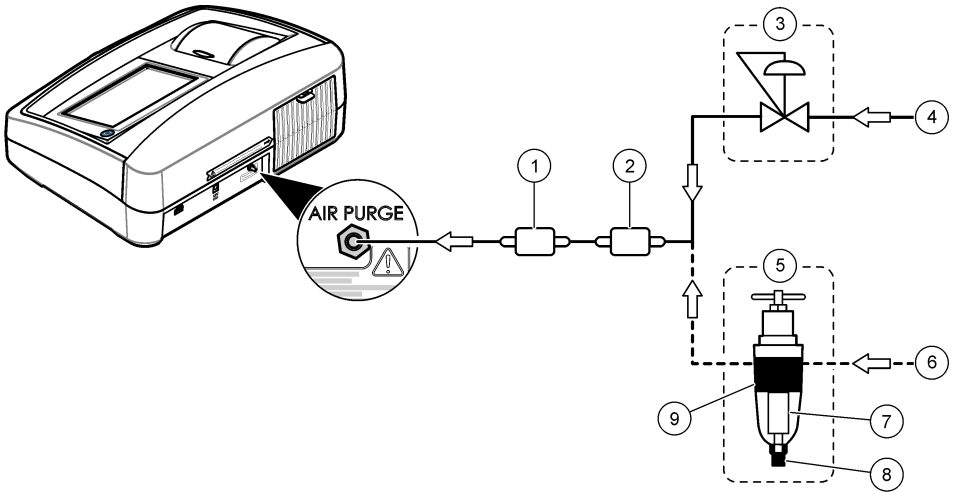

|   |  |
|---|--|
| 1 Particle filter (Balston DFU 9933- 05-BQ or equivalent) | 6 Shop air   |
| 2 Air dryer (Balston DAU 9933- 05-101 or equivalent)      | 7 Filter (Balston 100-12-BX or equivalent)         |
| 3 Pressure regulator                                      | 8 Auto drain (Balston 20-105 or equivalent)        |
| 4 Instrument air  | 9 Filter housing (Balston FR-920-30 or equivalent) |
| 5 Coalescing filter/regulator (0–30 psig)                 |  |

## Section 7 Maintenance

### ▲ CAUTION



Multiple hazards. Only qualified personnel must conduct the tasks described in this section of the document.

### 7.1 Clean spills

### ▲ CAUTION



Chemical exposure hazard. Dispose of chemicals and wastes in accordance with local, regional and national regulations.

1. Obey all facility safety protocols for spill control.
2. Discard the waste according to applicable regulations.

### 7.2 Clean the instrument

Clean the exterior of the instrument with a moist cloth, and then wipe the instrument dry.

## 7.3 Instrument utilities

1. Push **Home** to see the instrument model, version, serial number and location name.
2. Push **Diagnostics**.
3. Select an option.

| Option                   | Description  |
|--------------------------|--|
| <b>Factory Service</b>   | For factory/service use only.  |
| <b>Instrument Backup</b> | <b>Store</b> —Saves a backup of all the instrument settings and log files to a USB flash drive. <b>Restore</b> —Copies the instrument settings and log files from a USB flash drive to the instrument. Overwrites all the instrument settings. |
| <b>Instrument Update</b> | Installs an instrument update on the instrument from a USB flash drive.  |
| <b>Service Time</b>      | Shows the date entered for the last service date and for the next service date. When set to on, a service reminder shows on the display when service is due.   |

## 7.4 Install an instrument update

Find the instrument update file on the product website. Save the file from the website to a USB flash drive, then do the steps that follow to install the update.

1. Push **Diagnostics>Instrument Update**.
2. Put the USB flash drive into the rear USB port of the instrument. Push **OK**. The update starts.  
*Note: Use only the rear USB port of the instrument for the update.*
3. Wait for the instrument to power off and on. Remove the USB flash drive.

## Section 8 Troubleshooting

| Message                                    | Solution  |
|--|---|
| <b>Startup</b>                             |   |
| The self-check stopped.<br>Close the lid.  | Close the lid. Push <b>Close</b> .  |
| The self-check stopped.<br>Hardware error. | Set the power to off, wait 20 seconds and then set the power to on again. If the self check is not successful, record the error number and contact technical support.<br>Error numbers: 0: RTC; 1: Touch IC; 2: Slide door; 3: Dark voltage—Close the door until a click is heard. Start the instrument again. 4: Amplifier coefficient—Make sure that the power supply is connected to an electrical outlet that has a protective earth ground. 5: Infrared LED voltage; 6: Infrared LED current; 9: SDRAM; 10: NOR flash; 11: SPI flash; 12: Battery voltage; 13: Power supply voltage—Make sure that the correct power supply is used. |
| Next calibration is due!                   | Calibrate the instrument. Refer to <a href="#">Calibrate the turbidimeter with StablCal Standards</a> on page 14.<br><i>Note: The calibration reminder is set to on. Refer to <a href="#">Configure the calibration settings</a> on page 15.</i>  |
| Next service is due!                       | Contact technical support.<br><i>Note: The service reminder is set to on. Refer to <a href="#">Instrument utilities</a> on page 32.</i>   |

| Message   | Solution  |
|---|---|
| Next verification is due!                           | Do a calibration verification. Refer to <a href="#">Calibration verification</a> on page 17.<br><i>Note: The verification reminder is set to on. Refer to <a href="#">Configure the verification settings</a> on page 18.</i>   |
| <b>Reading</b>                                      |   |
| Hardware error / instrument error                   | Set the power to off, wait 20 seconds and then set the power to on again. If the problem continues, contact technical support.  |
| The calibration range is exceeded.                  | The measured turbidity is more than the calibration range of the instrument. Select a calibration curve for the full measurement range. Refer to <a href="#">Configure the calibration settings</a> on page 15.   |
| The measurement range is exceeded.                  | The measured turbidity is more than the measurement range of the instrument.  |
| <b>Calibration/Verification</b>                     |   |
| Instrument error                                    | Examine the standards. Start the calibration or verification again. If calibration (or verification) is not successful, contact technical support.  |
| The standard is not stable.                         | Use the correct calibration standards. Invert the standard until no bubbles or large particles show.  |
| The standard value is out of the measurement range. | Use the correct calibration standards. Invert the standards. Make sure to measure the standards in ascending order.   |
| The standard value is too low.                      | The wrong calibration standard is in the vial compartment. Make sure that the standard has not expired.<br>Put the correct calibration standard in the vial compartment. Make sure to invert the standard.  |
| The standard value is too high.                     | The wrong calibration standard is in the vial compartment. Make sure that the standard has not expired.<br>Put the correct calibration standard in the vial compartment.  |
| Verification failed.                                | Examine the verification standard. Calibrate the instrument. Refer to <a href="#">Calibrate the turbidimeter with StabCal Standards</a> on page 14.<br>If verification is not successful after calibration, contact technical support.  |
| <b>Instrument update</b>                            |   |
| Copy from USB Memory failed                         | Remove large files from the USB flash drive that use too much space. Start the instrument update procedure again.<br>Remove the instrument update files from the USB flash drive. Save the instrument update files again to the USB flash drive.<br>Connect the USB flash drive to the instrument. Start the instrument update procedure again. |
| Instrument update file is missing                   | Remove the instrument update files from the USB flash drive. Save the instrument update files again to the USB flash drive.   |
| Instrument update file is corrupt                   | Connect the USB flash drive to the instrument. Start the instrument update procedure again.   |
| Not enough memory to update the instrument          | Contact technical support.  |

| Message   | Solution  |
|---|---|
| USB memory is not connected.  | Connect a USB flash drive to the instrument. Make sure that the file system "FAT32" is installed on the USB flash drive.<br>Set the power to off, wait 20 seconds and then set the power to on again. Connect the USB flash drive. Start the instrument update procedure again. |
| <b>Read/Write to USB flash drive</b>                                    |   |
| Cannot write to USB memory  | Connect a USB flash drive to the instrument. Make sure that the file system "FAT32" is installed on the USB flash drive.  |
| Cannot read from USB memory   | Set the power to off, wait 20 seconds and then set the power to on again. Look for remaining space on the USB flash drive.<br>Set the power to off, wait 20 seconds and then set the power to on again. Connect the USB flash drive to the instrument.                          |
| <b>Restore backup</b>   |   |
| No instrument backup is available.                                      | Connect a USB flash drive to the instrument. Make sure that the file system "FAT32" is installed on the USB flash drive.  |
| Not able to restore the backup  | Set the power to off, wait 20 seconds and then set the power to on again. Connect the USB flash drive. Start the instrument update procedure again.   |
| <b>Security</b>   |   |
| Invalid password  | Enter the correct password. If the password is lost, contact technical support.   |
| <b>Send data</b>  |   |
| Connect a receiving device.   | Examine the device connections. Set the Auto Send setting to off. Refer to <a href="#">Configure the measurement settings</a> on page 12.   |
| <b>Add sample IDs from list</b>   |   |
| No valid data found   | No sample ID file was found on the USB flash drive.   |
| Not able to read sampling date.   | Make sure that the date and time format is dd.mm.yyyy hh:mm.  |
| The instrument cannot read the Sample ID                                | Examine the text strings. Refer to <a href="#">Import sample IDs (optional)</a> on page 13.   |
| Problem/Error: Incorrect date<br>Possible cause: The wrong date format. | Make sure that the date and time format is dd.mm.yyyy hh:mm.  |
| The sample ID list full.<br>Data has not been added.                    | Remove the sample IDs that are not used. Add a new sample ID.   |

## Section 9 Replacement parts and accessories

**Note:** Product and Article numbers may vary for some selling regions. Contact the appropriate distributor or refer to the company website for contact information.

## Recommended standards

| Description  | Quantity | Item no. |
|--|----------|----------|
| Calibration kit, StablCal, sealed sample cells (<0.1, 20, 200, 1000 and 4000 NTU)                          | 1        | 2662105  |
| Gelex secondary turbidity standardization kit (stray light standard and 0–2, 0–20, 0–200 and 200–4000 NTU) | 1        | 2589000  |

## Replacement parts

| Description                            | Quantity | Item no. |
|--|----------|----------|
| Dust cover                             | 1        | 9649100  |
| Oiling cloth                           | 1        | 4707600  |
| Power cord, North America, 125 VAC     | 1        | 1801000  |
| Power cord, European, 250 VAC          | 1        | 4683600  |
| Power supply                           | 1        | 9673701  |
| Sample cells, 30 mL, 1 in. round glass | 6        | 2084900  |
| Silicone oil                           | 1        | 126936   |

## Accessories

| Description  | Quantity | Item no. |
|--|----------|----------|
| Calibration kit, StablCal, 100 mL each (<0.1, 20, 200, 1000 and 4000 NTU)                      | 1        | 2662110  |
| Calibration kit, StablCal, 500 mL each (<0.1, 20, 200, 1000 and 4000 NTU)                      | 1        | 2662100  |
| Filter disks, 0.2 micron   | 10/pkg   | 2323810  |
| Filter, membrane (without pad), 0.45 micron, 47 mm   | 200/pkg  | 1353001  |
| Filter paper, glass fiber, 1.5 micron, 47 mm   | 100      | 253000   |
| Formazin stock solution, 4000 NTU  | 100 mL   | 246142   |
| Formazin stock solution, 4000 NTU  | 500 mL   | 246149   |
| Sample degassing kit   | 1        | 4397500  |
| Sample degassing and filtration kit  | 1        | 4397510  |
| 0.1 NTU, StablCal™ low-level turbidity verification standards (not for instrument calibration) | 100 mL   | 2723342  |
| 0.3 NTU, StablCal™ low-level turbidity verification standards (not for instrument calibration) | 100 mL   | 2697942  |
| 0.5 NTU, StablCal™ low-level turbidity verification standards (not for instrument calibration) | 100 mL   | 2698042  |
| TenSette® Pipet, 1.0-10.0 mL,  | 1        | 1970010  |

**Accessories (continued)**

| Description                       | Quantity | Item no. |
|-----------------------------------|----------|----------|
| TenSette® Pipet Tips              | 250      | 2199725  |
| Volumetric flask, 100 mL, Class A | 1        | 1457442  |
| Volumetric flask, 200 mL, Class A | 1        | 1457445  |





**HACH COMPANY World Headquarters**

P.O. Box 389, Loveland, CO 80539-0389 U.S.A.  
Tel. (970) 669-3050  
(800) 227-4224 (U.S.A. only)  
Fax (970) 669-2932  
orders@hach.com  
www.hach.com

**HACH LANGE GMBH**

Willstätterstraße 11  
D-40549 Düsseldorf, Germany  
Tel. +49 (0) 2 11 52 88-320  
Fax +49 (0) 2 11 52 88-210  
info-de@hach.com  
www.de.hach.com

**HACH LANGE Sàrl**

6, route de Compois  
1222 Vézenaz  
SWITZERLAND  
Tel. +41 22 594 6400  
Fax +41 22 594 6499