



DOC022.53.80197

# PHC201

05/2021, Edition 3

**User Manual**

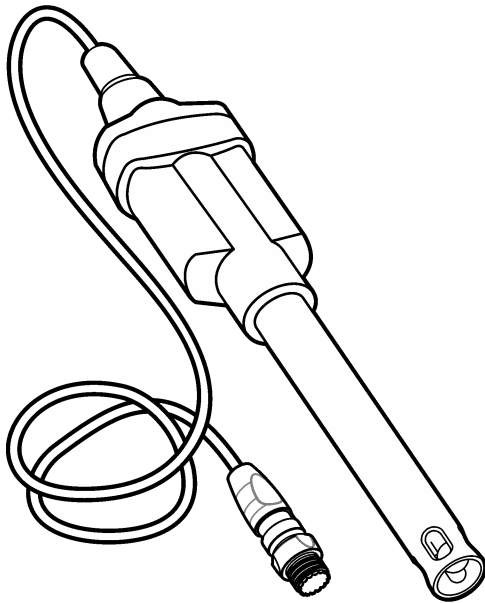



**Section 1 Product overview** ..... 3

**Section 2 Specifications** ..... 3

**Section 3 Safety information** ..... 4

    3.1 Intended use ..... 4

    3.2 Use of hazard information ..... 4

    3.3 Precautionary labels ..... 5

    3.4 Product hazards ..... 5

**Section 4 Preparation for use** ..... 5

**Section 5 Calibration** ..... 5

    5.1 Calibration notes ..... 5

    5.2 Calibration procedure ..... 6

**Section 6 Sample measurement** ..... 7

    6.1 Sample measurement notes ..... 7

    6.2 Sample measurement procedure ..... 7

**Section 7 Verify the calibration** ..... 8

    7.1 Verification procedure ..... 8

**Section 8 Maintenance** ..... 9

    8.1 Clean the probe ..... 9

    8.2 Soak procedure for dry probes ..... 9

    8.3 Storage ..... 10

**Section 9 Troubleshooting** ..... 10

**Section 10 Consumables** ..... 11

    10.1 Recommended standards ..... 12

    10.2 Accessories ..... 12



## Section 1 Product overview

The Intellical PHC201 series pH probes are digital, combination electrodes that measure the pH of many types of clean water samples. The probes have a non-refillable, semi-liquid gel-filled electrolyte and a built-in temperature sensor. Refer to [Figure 1](#).

**Note:** Do not use the probe to measure the pH of organic solvents, wastewater, samples with many solids or ultrapure samples of low ionic strength. For best accuracy do not use the probe to measure the pH of very alkaline samples.

**Figure 1 Probe overview**

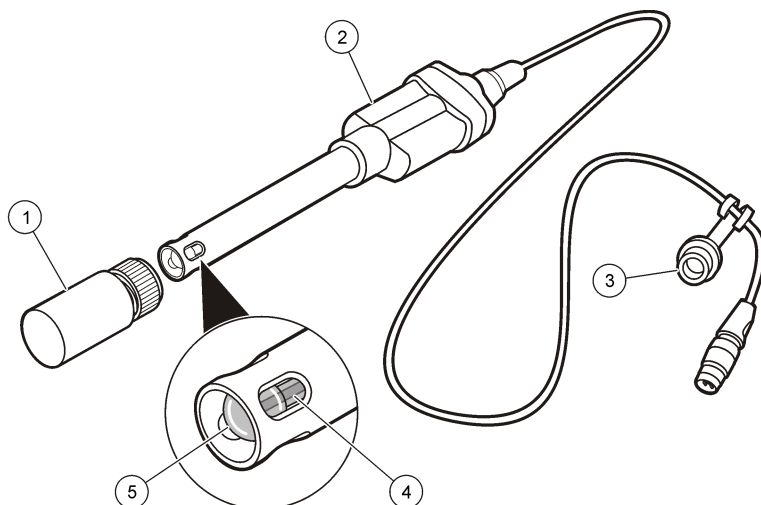

1 Probe soaker bottle with storage solution	4 Reference junction
2 Probe body	5 Glass bulb and temperature sensor
3 Probe soaker bottle holder	

## Section 2 Specifications

Specifications are subject to change without notice.

Specifications	Details
Probe type	Digital combination pH probe with non-refillable, semi-liquid gel electrolyte and built-in temperature sensor
pH range	0 to 14 pH
pH accuracy	±0.02 pH
Reference type	Ag/AgCl
Reference junction	Ceramic porous pin
Slope	-59 mV/pH (85 to 115% at 25 °C (77 °F) per Nernstian theoretical value)
Isopotential point	0 (±30) mV at 7.0 (±0.5) pH
Sodium (alkalinity) error	<20% at pH 14 in 1 M NaCl

Specifications	Details
Temperature accuracy	±0.3 °C (±0.54 °F)
Temperature sensor type	30 kΩ NTC thermistor
Operating temperature	0 to 80 °C (32 to 176 °F)
Storage temperature	5 to 40 °C (41 to 104 °F)
Minimum immersion depth	15 mm (0.59 in.)
Body material (standard)	Epoxy
Electrolyte	Non-refillable gel reference element, semi-liquid gel
Storage solution	Hach pH electrode storage solution <sup>1</sup> or 3 M KCl
Cable connection	M12 digital output and connector
Dimensions	Diameter: 12 mm (0.47 in.) Length: 175 mm (6.9 in.) total; 103 mm (4.1 in.) below head Cable length: PHC20101: 1 m (3.3 ft); PHC20103: 3 m (9.8 ft)
Weight (includes cable)	PHCxxx01: ~0.4 kg (0.9 lb); PHCxxx03: ~0.45 kg (1 lb)
Warranty	6 months on the probe. This warranty covers manufacturing defects, but not improper use or wear.
Certifications	CE, FCC/ISED

## Section 3 Safety information

### 3.1 Intended use

The Intellical probes are intended for use by individuals who measure water quality parameters in the laboratory. The Intellical probes do not treat or alter water.

### 3.2 Use of hazard information

#### ▲ DANGER

Indicates a potentially or imminently hazardous situation which, if not avoided, will result in death or serious injury.

#### ▲ WARNING

Indicates a potentially or imminently hazardous situation which, if not avoided, could result in death or serious injury.

#### ▲ CAUTION

Indicates a potentially hazardous situation that may result in minor or moderate injury.

#### NOTICE

Indicates a situation which, if not avoided, may cause damage to the instrument. Information that requires special emphasis.



<sup>1</sup> Use of other storage solutions can cause permanent damage to the probe.

### 3.3 Precautionary labels

Read all labels and tags attached to the instrument. Personal injury or damage to the instrument could occur if not observed. A symbol on the instrument is referenced in the manual with a precautionary statement.

	Electrical equipment marked with this symbol may not be disposed of in European domestic or public disposal systems. Return old or end-of-life equipment to the manufacturer for disposal at no charge to the user.
--	---

### 3.4 Product hazards

▲ CAUTION	
	Chemical exposure hazard. Obey laboratory safety procedures and wear all of the personal protective equipment appropriate to the chemicals that are handled. Refer to the current safety data sheets (MSDS/SDS) for safety protocols.
▲ CAUTION	
	Chemical exposure hazard. Dispose of chemicals and wastes in accordance with local, regional and national regulations.
▲ CAUTION	
	Personal injury hazard. Glass components can break. Handle with care to prevent cuts.

## Section 4 Preparation for use

New probes come with a soaker bottle that contains storage solution to keep the glass bulb and reference junction hydrated. Prepare the probe as follows.

1. Loosen the cap on the soaker bottle. Remove the soaker bottle from the probe.
2. Rinse the reference junction and glass bulb with deionized water. Blot dry with a lint-free cloth.
3. For faster stabilization, soak the probe for 3 or more minutes in the sample before use.
4. Make sure that the meter has the correct date and time settings. The service-life time stamp in the probe comes from the date and time settings in the meter.

*Note: Some meters automatically open the date and time settings when the meter starts for the first time, or after battery replacement.*

5. Connect the probe to the meter.

## Section 5 Calibration

The procedure that follows is applicable to meters that can connect to Intellical pH probes. Refer to the applicable meter documentation for meter operation and probe-specific settings.

### 5.1 Calibration notes

Read the notes that follow before calibration:

- Use prepared pH buffer solutions or mix pH buffer powder pillows with deionized water for calibration. Discard the prepared buffer solutions after each calibration.

- Use two or three buffer solutions for best results. Two buffer solutions are sufficient if the expected sample pH is between the pH of the two buffer solutions. The sequence in which the pH buffer solutions are used is not important. Use buffer solutions that are 2 or more pH units apart.
- For a one-point calibration, use a pH buffer near the expected sample pH.
- Use the default calibration options or change the options in the probe settings menu.
- Use the single display mode for calibration when more than one probe is connected to the meter (if applicable).
- Calibrate the probes and verify the calibration regularly for best results. Use the meter to set calibration reminders.
- The calibration data is stored in the probe. When a calibrated probe is connected to a different meter with the same calibration options, a new calibration is not necessary.
- Air bubbles below the sensor when in solution can cause a slow response or error in the calibration. Make sure to remove air bubbles during calibration.
- The pH buffer solutions have known pH values at different temperatures. The meter uses the mV and temperature readings of the probe in the pH buffer solutions to calculate a calibration slope. During measurements, the meter adjusts the slope for the sample temperature to determine the pH value of the sample.

## 5.2 Calibration procedure

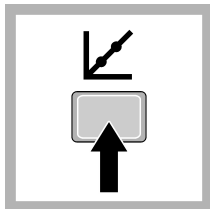

**1.** Go to the calibrate menu. Select the probe, if applicable. The display shows the pH buffer solutions to use for calibration.

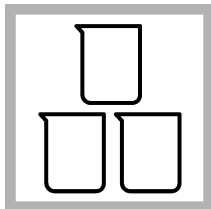

**2.** Prepare or pour the pH buffer solutions in different beakers.

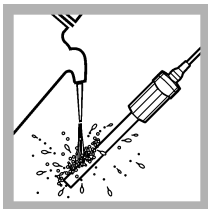

**3.** Rinse the probe with deionized water. Dry the probe with a lint-free cloth.

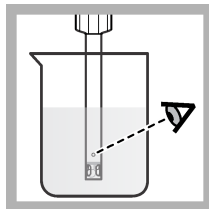

**4.** Put the probe in the first pH buffer solution. Make sure that the sensor and reference junction are fully in the solution. Do not put the probe on the bottom or sides of the beaker.

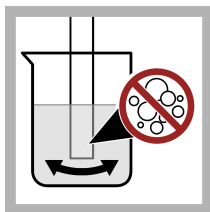

**5.** Shake the probe from side to side to refresh the reference junction and remove air bubbles.

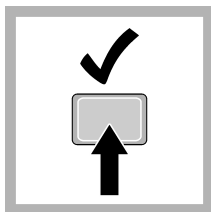

**6.** Stir slowly, then read the pH value of the buffer solution. The display shows the temperature-corrected pH value when the reading is stable.

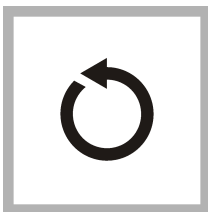

**7.** Continue with steps 3 through 6 for the remaining buffers or select Done.

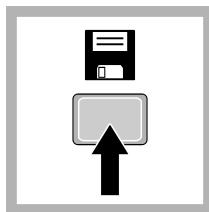

**8.** Save the calibration.



## Section 6 Sample measurement

The procedure that follows is applicable to meters that can connect to Intellical pH probes. Refer to the applicable meter documentation for meter operation and probe-specific settings.

### 6.1 Sample measurement notes

Read the notes that follow before sample measurements.

- Rinse the probe with deionized water and dry with a lint-free cloth between measurements to prevent contamination.
- If complete traceability is necessary, enter a sample ID and operator ID before measurement. Refer to the meter manual for instructions.
- The meter automatically saves the measurement data when the user manually reads each data point and when the meter is set to read at regular intervals. The user must manually save each data point when the meter is set to read continuously.
- Air bubbles below the sensor can cause a slow response or error in the measurement. Make sure to remove air bubbles before and during measurements.

### 6.2 Sample measurement procedure

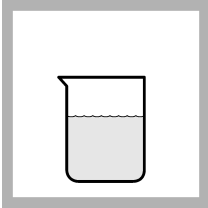

1. Collect the sample.



2. Rinse the probe with deionized water. Dry the probe with a lint-free cloth.

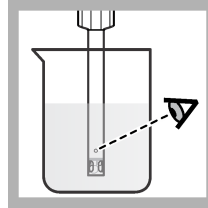

3. Put the probe in the sample with the sensor and reference junction fully in the sample. Do not put the probe on the bottom or sides of the beaker.

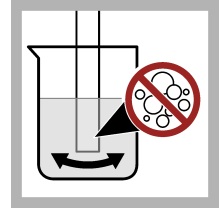

4. Shake the probe from side to side to refresh the reference junction and remove air bubbles.

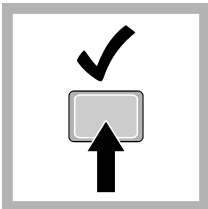

5. Stir gently, then read the pH value of the sample. The display shows the temperature-compensated pH value when the reading is stable.

## Section 7 Verify the calibration

Measure the pH value of a fresh pH buffer solution to make sure the result is accurate. The meter compares the selected pH buffer value to the measured pH value and accepts or rejects the measurement. The user can change the pH buffer solution and acceptance criteria for verification in the probe-specific settings.

**Note:** Password protection may prevent access to the acceptance criteria.

### 7.1 Verification procedure

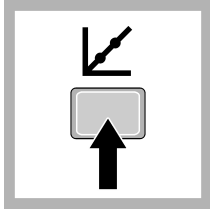

1. Go to the verification menu. The display shows the pH buffer solution to use for verification.

**Note:** Menu name for HQd meters: Run check standard.

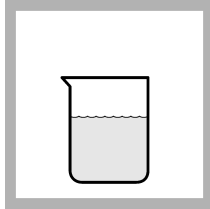

2. Prepare or pour the pH buffer solution into a beaker.

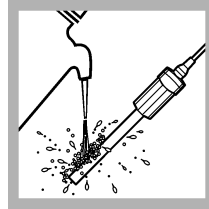

3. Rinse the probe with deionized water. Dry the probe with a lint-free cloth.

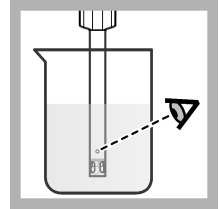

4. Put the probe in the pH buffer solution with the sensor and reference junction fully in the solution. Do not put the probe on the bottom or sides of the beaker.

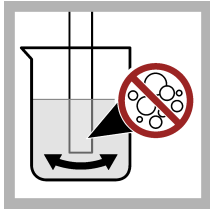

5. Shake the probe from side to side to refresh the reference junction and remove air bubbles.

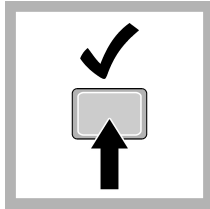

6. Stir gently, then read the pH value of the buffer solution. The meter accepts or rejects the result.

## Section 8 Maintenance

Regular maintenance is necessary for the best accuracy, stabilization time and life of the probe. Keep the probe in the recommended storage solution between measurements.

### 8.1 Clean the probe

Clean the probe regularly to remove contamination and to keep the reference junction open. Symptoms of contamination:

- Incorrect or irregular readings
  - Slow stabilization times
  - Calibration errors
  - Sample material stays on the probe
1. Rinse the probe with deionized water. Use warm (35–45 °C (95–113 °F)) deionized water to remove storage solution that dries on the probe. Dry the probe body with a lint-free cloth.
  2. Soak the glass bulb and reference junction in the applicable cleaning solution for the specified time. Refer to [Table 1](#) and [Consumables](#) on page 11.
  3. Rinse or soak the probe for 1 minute in deionized water. Dry the probe body with a lint-free cloth.
  4. Soak the probe in pH 4 buffer for 20 minutes.
  5. Rinse the probe with deionized water. Dry the probe body with a lint-free cloth.

**Table 1 Cleaning solution**

Contamination	Cleaning solution	Active component	Soak time
General contamination	Electrode cleaning solution for regular maintenance	KATHON™ CG, DECONEX®11	12–16 hours
Minerals	Electrode cleaning solution for minerals/inorganic contamination	Phosphoric acid (~10%)	10–15 minutes
Fats, grease and oils	Electrode cleaning solution for fats, oils and grease contamination	KATHON™ CG, TRITON® X	2 hours maximum
Proteins	Electrode cleaning solution for proteins/organic contamination	Pepsin in HCl	3 hours maximum
Wastewater and organic compounds	Electrode cleaning solution, extra strong	Sodium hypochlorite	5–10 minutes
Blockage of porous pin/diaphragm reference junctions	Electrode cleaning solution for porous pin/diaphragm reference junctions	Thiourea	3 hours with stirring or until the porous plug becomes white

### 8.2 Soak procedure for dry probes

If the glass bulb becomes dry, complete the steps that follow to hydrate the probe.

1. Soak the probe tip in pH 4 and pH 7 buffer solutions for 5 minutes in each solution.
2. Rinse the probe with deionized water. Blot dry with a lint-free cloth.
3. Calibrate the probe.

## 8.3 Storage

### NOTICE

Probes can become permanently damaged if kept in a storage solution that is not specified by the manufacturer. Use only the specified storage solution (Hach pH electrode storage solution or 3 M KCl).

Do not store the probe in deionized water or in samples of low ionic strength. For short-term storage, the probe can stay in the sample for a maximum of 2 hours if the sample pH is not high. Put the soaker bottle that contains the storage solution on the probe when not in use. Refer to [Figure 2](#). Keep the probe in a vertical position with the sensor and reference junction below the liquid level in the soaker bottle. Add storage solution to the soaker bottle if necessary.

**Figure 2 Probe storage**

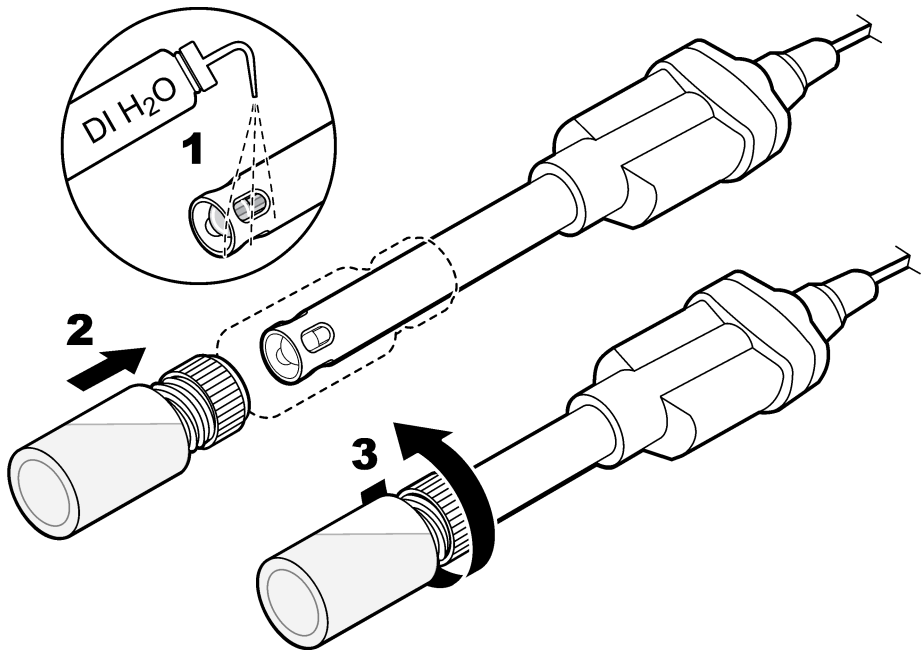

## Section 9 Troubleshooting

Keep the probe clean and in the recommended storage solution when not in use for the best accuracy, stabilization time and life of the probe.

Problem	Possible cause	Solution
Decreased probe performance causes slow stabilization and prevents accurate calibrations or measurements.	The glass sensor is dirty.	Clean and condition the probe. Refer to <a href="#">Clean the probe</a> on page 9.
	The glass sensor has become dry.	Clean and condition the probe. Refer to <a href="#">Maintenance</a> on page 9.
	The calibration slope of the probe has changed.	Increase the accepted slope limit settings if possible, or contact technical support.

Problem	Possible cause	Solution
Sample properties cause slow stabilization or inaccurate measurements.	The sample absorbs carbon dioxide (CO <sub>2</sub> ) from the air, which causes the pH value to slowly decrease in low ionic strength (LIS) or high purity samples.	Use the LIS chamber for LIS/high purity samples to prevent CO <sub>2</sub> absorption.
	The sample temperature is low, or there is a large temperature difference between samples.	Increase the sample temperature or adjust the temperature of different samples to be the same (within 2 °C (3.6 °F)).
Procedure problem causes slow stabilization and prevents accurate calibrations or measurements.	The probe is not conditioned to the sample.	Soak the probe in the sample before sample measurements. Refer to <a href="#">Preparation for use</a> on page 5.
	Air bubbles are around or below the probe tip.	Carefully tap or shake the probe to remove air bubbles.
	The electrical connection through the reference junction is not sufficient.	Shake the probe in the solution from side to side to refresh the reference junction.
	The stir speed is too slow or too fast.	Try a different stir speed.
	An incorrect buffer solution was used or the buffer solution has contamination.	Use the specified buffer solutions of good quality.

## Section 10 Consumables

**Note:** Product and Article numbers may vary for some selling regions. Contact the appropriate distributor or refer to the company website for contact information.

Description	Quantity <sup>2</sup>	Item no.
Hach pH electrode storage solution	500 mL	2756549
3 M KCl solution	50 mL <sup>3</sup>	2756559
Electrode cleaning solution for regular maintenance	500 mL	2965249
Electrode cleaning solution for minerals/inorganic contamination	500 mL	2975149
Electrode cleaning solution for proteins/organic contamination	250 mL	C20C370
Electrode cleaning solution for fats, oils and grease contamination	500 mL	2964449
Electrode cleaning solution for porous pin/diaphragm reference junctions	250 mL	C20C380

<sup>2</sup> Larger quantities are available for some items.

<sup>3</sup> Larger quantities are available.

## 10.1 Recommended standards

Description	Unit	Item no.
pH 4.01 buffer solution, Singlet one-use packets, 20 mL each	20/pkg	2770020
pH 7.00 buffer solution, Singlet one-use packets, 20 mL each	20/pkg	2770120
pH 10.01 buffer solution, Singlet one-use packets, 20 mL each	20/pkg	2770220
pH 4.01 and pH 7.00 buffer solution kit, Singlet one-use packets, 20 mL each	2 x 10/pkg	2769920
pH 7.00 and 10.01 buffer solution kit, Singlet one-use packets, 20 mL each	2 x 10/pkg	2769820
pH color-coded buffer solution kit (NIST), 500 mL, includes:	1	2947600
pH 4.01 ± 0.02 pH buffer (NIST)	500 mL	2283449
pH 7.00 ± 0.02 pH buffer (NIST)	500 mL	2283549
pH 10.01 ± 0.02 pH buffer (NIST)	500 mL	2283649
Powder pillows:		
pH 4.01 ± 0.02 pH buffer powder pillow (NIST)	50/pkg	2226966
pH 7.00 ± 0.02 pH buffer powder pillow (NIST)	50/pkg	2227066
pH 10.01 ± 0.02 pH buffer powder pillow (NIST)	50/pkg	2227166
Radiometer Analytical (IUPAC Series certified pH standards):		
pH 1.679 ± 0.010 at 25 °C (77 °F)	500 mL	S11M001
pH 4.005 ± 0.010 at 25 °C (77 °F)	500 mL	S11M002
pH 6.865 ± 0.010 at 25 °C (77 °F)	500 mL	S11M003
pH 7.000 ± 0.010 at 25 °C (77 °F)	500 mL	S11M004
pH 9.180 ± 0.010 at 25 °C (77 °F)	500 mL	S11M006
pH 10.012 ± 0.010 at 25 °C (77 °F)	500 mL	S11M007
pH 12.45 ± 0.05 at 25 °C (77 °F)	500 mL	S11M008
pH buffer 1.09, technical	500 mL	S11M009
pH buffer 4.65, technical	500 mL	S11M010
pH buffer 9.23, technical	500 mL	S11M011

## 10.2 Accessories

Description	Quantity	Item no.
Beaker, 30 mL, plastic, colorless	80/pkg	SM5010
Beaker, 30 mL, plastic, red	80/pkg	SM5011
Beaker, 30 mL, plastic, yellow	80/pkg	SM5012
Beaker, 30 mL, plastic, blue	80/pkg	SM5013
Beaker, 30 mL, plastic, green	80/pkg	SM5014

## 10.2 Accessories (continued)

Description	Quantity	Item no.
Beaker dispenser and holder, 30 mL	1	923-656
Beaker holder, 30 mL	1	923-556
Beaker, 100 mL, polypropylene	1	108042
Disposable wipes, 11 x 22 cm	280/pkg	2097000
Wash bottle, polyethylene, 500 mL	1	62011
Probe stand for standard Intellical probes	1	8508850
Soaker bottle for probe storage	1	5192900









**HACH COMPANY World Headquarters**

P.O. Box 389, Loveland, CO 80539-0389 U.S.A.  
Tel. (970) 669-3050  
(800) 227-4224 (U.S.A. only)  
Fax (970) 669-2932  
orders@hach.com  
www.hach.com

**HACH LANGE GMBH**

Willstätterstraße 11  
D-40549 Düsseldorf, Germany  
Tel. +49 (0) 2 11 52 88-320  
Fax +49 (0) 2 11 52 88-210  
info-de@hach.com  
www.de.hach.com

**HACH LANGE Sàrl**

6, route de Compois  
1222 Vézenaz  
SWITZERLAND  
Tel. +41 22 594 6400  
Fax +41 22 594 6499